**THE
ONE**

2014

EXPERTISE

LEDS-C4 es una empresa con más de 40 años de experiencia en el diseño, desarrollo y producción de aparatos de iluminación.

LEDS-C4 is a company with over 40 years' experience in design, development and manufacture of lighting solutions.

LEDS-C4 est une société forte de plus de 40 ans d'expérience en conception, développement et fabrication de solutions d'éclairage.

LEDS-C4 ist eine Firma mit über 40 Jahren Erfahrung im Design, Entwicklung und Herstellung von Lichtlösungen.

LEDS-C4 e' un'azienda con oltre quaranta anni di esperienza nel settore dell'illuminazione, specializzata nello sviluppo prodotti, progettazione e soluzioni illuminotecniche.

A LEDS-C4 é uma empresa com mais de 40 anos de experiência em design, desenvolvimento e fabrico de soluções de iluminação.

LEDS-C4 - это компания с более, чем сорокалетним опытом работы в дизайне и производстве светильников.

LEDS-C4 to firma z ponad 40-letnim doświadczeniem w rozwoju, projektowaniu i produkcji rozwiązań oświetleniowych.

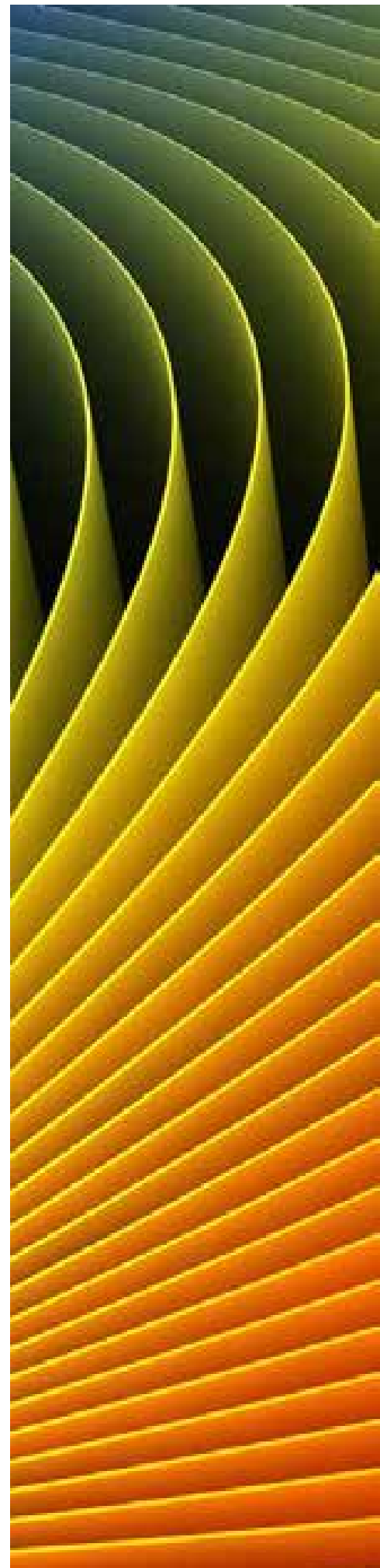



KEY FACTORS

KNOW-HOW

**IN-HOUSE
DESIGN &
ENGINEERING &
TESTING &
MANUFACTURING**



LOGISTICS CENTRE 150,000 CUBIC METRES.

■ Instalaciones propias de fabricación y un amplio departamento técnico (más de 30 profesionales) confieren un valor añadido.

■ Herstellung im eigenen Werk und eigene Technikabteilung (mehr als 30 Techniker) sorgen für Zusatzwert.

■ Собственные производственные мощности и большой технический отдел (более 30 специалистов) обеспечивают дополнительные преимущества.

■ Our manufacturing facilities and a large technical department (over 30 professionals) provide added value.

■ Il nostro valore aggiunto è il risultato di installazioni di produzione proprie e di un ampio e qualificato staff tecnico (composto da oltre 30 professionisti).

■ Własne zakłady produkcyjne i obszerny dział techniczny (ponad 30 fachowców) dostarcza wartości dodanej.

■ La société dispose de ses propres installations de fabrication et d'un vaste département technique (plus de 30 professionnels) qui lui confèrent de la valeur ajoutée.

■ A empresa dispõe das suas próprias instalações de fabrico e de um vasto departamento técnico (mais de 30 profissionais) factores que lhe conferem um valor acrescentado.

VANGUARD
INNOVATION
FUTURE
MATERIALS
DESIGN
TECHNOLOGY
TRENDS



- Led ZHAGA.
- Control y unificación del Binning de los led.
- Integración de la luz en la arquitectura.
- Luminarias bifuncionales.
- Materiales sostenibles.

- ZHAGA LED.
- Control and unification of LED binning.
- Integration of light in architecture.
- Bifunctional luminaires.
- Sustainable materials.

- Led ZHAGA.
- Contrôle et unification du binning des LED.
- Intégration de la lumière dans l'architecture.
- Luminaires bifonctionnels.
- Matériaux durables.

- LED ZHAGA.
- Steuerung und Vereinheitlichung des Binning der LED.
- Integration von Licht in die Architektur.
- Bifunktionale Leuchten.
- Nachhaltige Materialien.

- Led ZHAGA.
- Controllo e unificazione del Binning dei led.
- Integrazione della luce nell'architettura.
- Lampade bifunzionali.
- Materiali sostenibili.

- LED ZHAGA.
- Controlo e unificação do Binning dos LED.
- Integração da luz na arquitetura.
- Luminárias bifuncionais.
- Materiais sustentáveis.

- Светодиод ZHAGA.
- Контроль и унификация биннинга (классификации) светодиодов.
- Превращение света в часть архитектуры.
- Бифункциональные светильники.
- Долговечные материалы

- Dioda ZHAGA.
- Kontrola i ujednolicenie binningu diod.
- Zintegrowanie światła z architekturą.
- Dwufunkcyjne oprawy oświetleniowe.
- Trwałe materiały.

HIGH PERFORMANCE



- Dos años mínimo de garantía.
- Posibilidad de extensión de garantía.
- Deux ans de garantie minimum.
- Possibilité d'extension de garantie.
- Garanzia minima: 2 anni
- Possibilità di estensione della garanzia.
- Минимум два года гарантии.
- Возможность продления гарантийного срока.
- A minimum of two years' guarantee.
- Option to extend the guarantee.
- Zwei Jahre Mindestgarantie.
- Möglichkeit zur Verlängerung der Garantie.
- Como mínimo, dois anos de garantia.
- Possibilidade de extensão de garantia.
- Minimalnie dwa lata gwarancji.
- Możliwość przedłużenia gwarancji.



- Un estricto control de calidad en cada parte del proceso de producción garantiza la excelencia del producto.
- Strict quality control during each phase of the production process guarantees product excellence.
- Un contrôle de qualité rigoureux à chaque stade du processus de production assure l'excellence du produit.
- Eine strikte Qualitätskontrolle in allen Verfahrensschritten garantiert die Exzellenz unserer Produkte.
- L'eccellenza dei nostri prodotti è garantita dal rigoroso ed esaustivo controllo di qualità al quale è sottoposto.
- Um rigoroso controlo de qualidade em cada fase do processo produtivo garante a excelência do produto.
- Строгий контроль качества на каждом этапе производственного процесса гарантирует получение превосходного продукта.
- Rygorystyczna kontrola jakości na każdym etapie procesu produkcyjnego zapewnia doskonały produkt.

ECO SUSTAINABLE



■ El modelo de gestión de LEDS-C4 garantiza que la actividad de la empresa sólo tenga efectos positivos tanto en su entorno social como ambiental.

■ Das Verwaltungsmodell von LEDS-C4 garantiert, dass die Aktivität des Unternehmens nur positive Auswirkungen auf das soziale Umfeld und die Umwelt hat.

■ Модель управления LEDS-C4 обеспечивает положительный эффект от деятельности предприятия как на окружающую среду, так и на общество.

■ The LEDS-C4 management model guarantees that the company's activities only have positive effects on both its social and environmental spheres.

■ Grazie al nostro modello di gestione l'impatto esterno della LEDS-C4, tanto a livello ambientale quanto a livello sociale, produce unicamente effetti positivi.

■ Model zarządzania LEDS-C4 zapewnia, że działalność firmy ma tylko pozytywne skutki zarówno dla otoczenia społecznego jak i środowiska naturalnego.

■ Grâce à son modèle de gestion, l'activité de LEDS-C4 n'a que des répercussions positives sur son environnement, tant sur le plan social qu'environnemental.

■ O modelo de gestão da LEDS-C4 garante que a atividade da empresa só tem efeitos positivos tanto em termos sociais como ambientais.

COLOUR CONTROL

Conscientes de la importancia que adquiere la tonalidad de color en los led, LEDS-C4 ha desarrollado un estricto procedimiento de control en sus luminarias para asegurar que la tonalidad se mantenga constante para cada temperatura de color.

- Unificación de las temperaturas de color por cada tonalidad.
- Segmentación estricta de los bins y steps MacAdam.
- Selección de fabricantes de led con garantías de producto e innovación.
- Doble verificación de los procesos.

Alle Leuchten von LEDS-C4, die mit LEDs bestückt sind, durchlaufen eine strenge Qualitätskontrolle, um sicherzustellen, dass der Farbton bei allen Farbtemperaturen unverändert bleibt.

- Vereinheitlichung der Farbtemperaturen der verschiedenen Farbtöne.
- Akkurate Segmentierung von Bins und Steps MacAdam.
- Auswahl von LED-Herstellern, die Qualität und Innovation garantieren.
- Doppelte Überprüfung der Prozesse.

Сознавая важность оттенка цвета светодиодов, LEDS-C4 разработала строгую процедуру контроля светильников для обеспечения постоянного цвета для каждой отдельно взятой цветовой температуры.

- Унификация цветových температур для каждого оттенка
- Лаборатория точной сегментации типов и шагов МакАдама
- Выбор производителей светодиодов, дающих гарантии надежности и современности продукта.
- Двойная проверка процессов.

Conscious of the importance of colour tone in LEDs, LEDS-C4 has developed a strict review procedure for its luminaires in order to ensure that the tone remains constant for each colour temperature.

- Unification of colour temperatures for each tone.
- Accurate segmentation of MacAdam bins and steps.
- Selection of LED manufacturers who provide product guarantees and innovation.
- Double-checking of processes.

Consapevole di quanto sia importante la variabile colore nei led, LEDS-C4 applica una rigida procedura di controllo tale da garantirne l'invariabilità.

- Unificazione delle temperature di colore per ciascuna tonalità.
- Segmentazione accurata dei bin e degli step MacAdam.
- Selezione dei produttori di led con garanzie di prodotto e innovazione.
- Duplice verifica dei processi.

Świadomi znaczenia jakiego nabiera tonacja koloru w diodach, LEDS-C4 opracowała rygorystyczną procedurę kontrolującą jej oprawy oświetleniowe w celu zagwarantowania, że tonacja będzie utrzymana niezmienna dla każdej temperatury koloru.

- Ujednolicenie temperatur koloru dla każdej tonacji
- Staranny podział binów i stopni MacAdam
- Dobór producentów diod gwarantujących produkt i jego innowacyjność.
- Podwójne sprawdzanie procesów.

Conscients de l'importance qu'acquiert la tonalité de couleur dans les LED, la société LEDS-C4 a mis au point une procédure de contrôle rigoureuse dans ses luminaires en vue d'assurer le maintien d'une tonalité constante pour chaque température de couleur.

- Unification des températures de couleur pour chaque tonalité.
- Segmentation précise des bins et des steps MacAdam.
- Sélection de fabricants de LED qui offrent des garanties en termes de produit et d'innovation.
- Double vérification des processus.

Cientes da importância da tonalidade de cor nos LED, a LEDS-C4 desenvolveu um estrito procedimento de controlo das suas luminárias para assegurar que a tonalidade se mantém constante para cada temperatura de cor.

- Unificação das temperaturas de cor por cada tonalidade.
- Segmentação cuidada dos bins e steps MacAdam.
- Seleção de fabricantes de LED com garantias de produto e inovação.
- Dupla verificação dos processos.

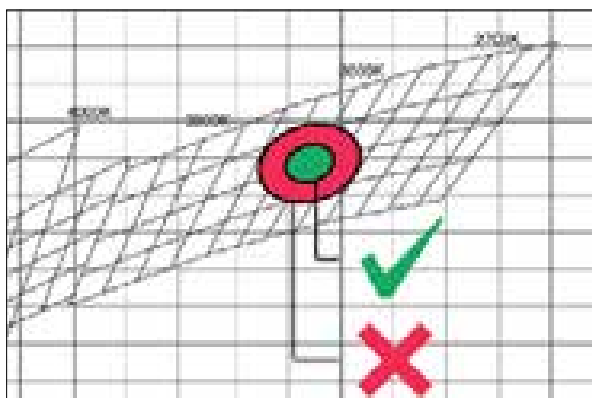
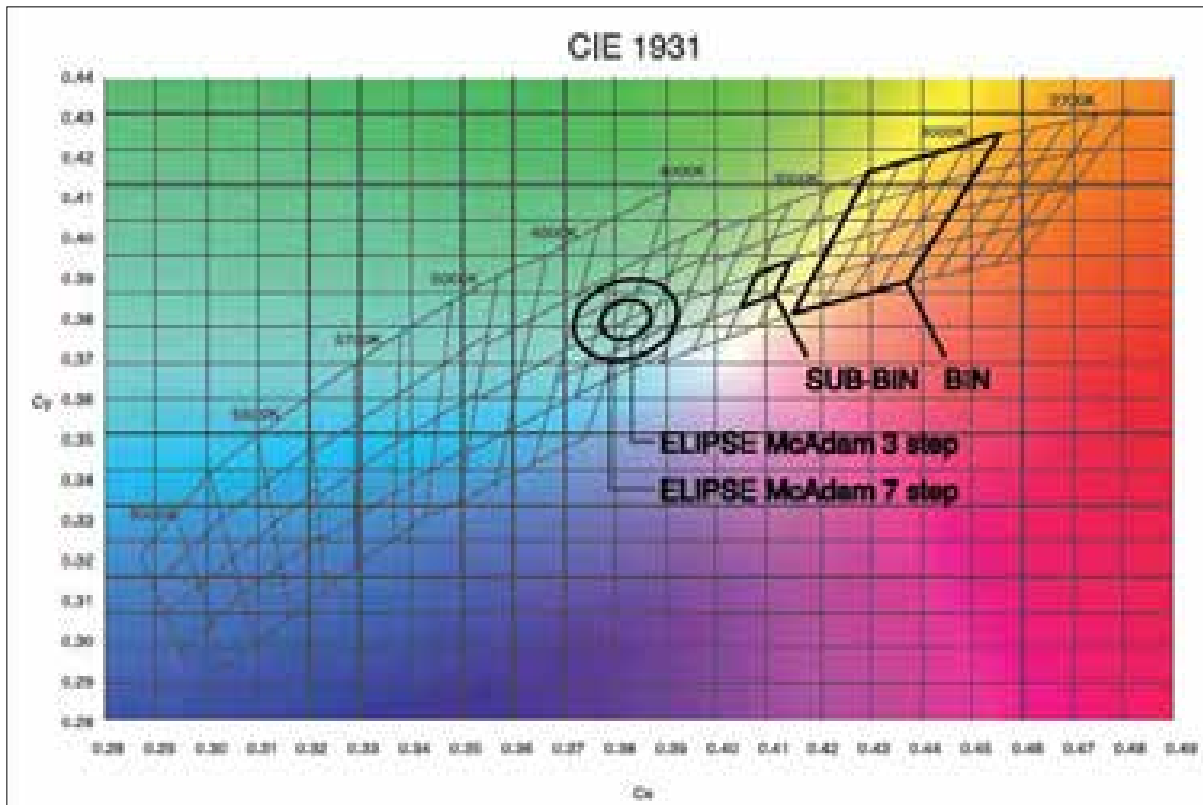

MAC ADAM

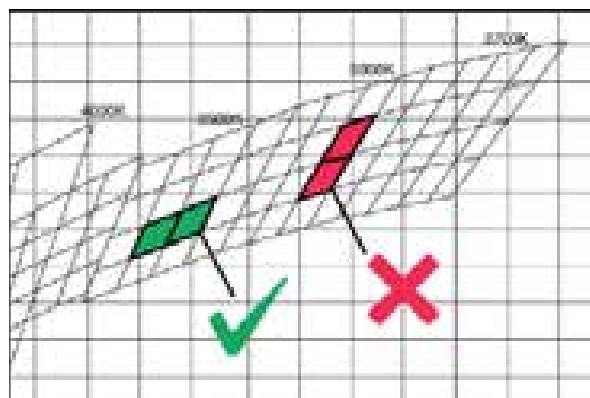

BINS

INTEGRAL LIGHTING EXPERIENCE



LAS ARENAS SHOPPING CENTER - BARCELONA (SPAIN)



CONSULTORÍA DE ILUMINACIÓN
LIGHTING CONSULTANCY
LE CONSEIL EN ILLUMINATION
CONSULENZA DI ILLUMINAZIONE
LICHTPLANUNG UND BELEUCHTUNGSBERATUNG
CONSULTADORIA EM ILUMINAÇÃO
КОНСУЛЬТАЦІЯ ПО ОСВЕЩЕНІЮ
DORADZTWO OŚWIETLENIOWE

DIALux

BESPOKE SOLUTIONS CUSTOM MADE



ST. REGIS HOTEL - DOHA (QATAR)

■ Capacidad para desarrollar a medida cualquier solución requerida.

■ Kapazität zur Entwicklung aller benötigten technischen Lösungen.

■ Возможность разработки абсолютно индивидуального решения для любых потребностей.

■ Ability to develop any bespoke solution required.

■ Capacità di sviluppare su misura qualsiasi soluzione richiesta.

■ Zdolność opracowania rozwiązania na miarę każdej potrzeby.

■ Capacité à développer n'importe quelle solution requise sur mesure.

■ Capacidade para desenvolver qualquer solução necessária à medida.

HOSPITALITY
OUTDOOR
RETAIL
RESIDENTIAL
URBAN
COMMERCIAL
ARCHITECTURAL
SPA

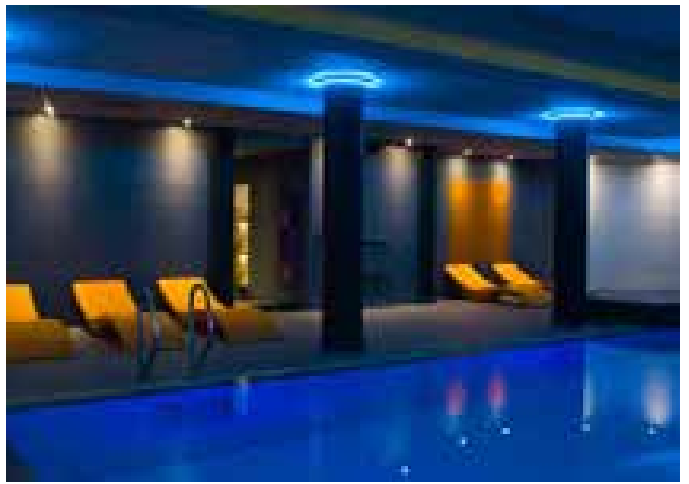

OUR PRODUCTS

TECHNICAL
DECORATIVE
OUTDOOR
EMOTIONAL

TECHNICAL



46-77
**SPOTLIGHTS
AND TRACKS**
PROYECTORES Y CARRILES
PROJECTEURS ET RAILS
STRAHLER UND SCHIENEN
PROIETTORI E BINARI
PROJETORES E CALHAS
ПРОЖЕКТОРЫ И ШИНОПРОВОДЫ
PROJEKTORY I SZYNY



78-167
DOWNLIGHTS
DOWNLIGHTS
DOWNLIGHTS
DOWNLIGHTS
DOWNLIGHTS
DOWNLIGHTS
ПОТОЛОЧНЫЕ
OPRAWY TYPU DOWNLIGHT



168-179
**FLUORESCENT LINEAL
LIGHTING SYSTEMS**
SISTEMAS DE FLUORESCENCIA LINEAL
SYSTÈMES À FLUORESCENCE LINÉAIRE
LINEALE LEUCHTSTOFFRÖHRENSYSTEME
SISTEMI DI FLUORESCENZA LINEARE
SISTEMAS LINEARES DE ILUMINAÇÃO
FLUORESCENTE
ЛИНЕЙНЫЕ ЛЮМИНЕСЦЕНТНЫЕ СИСТЕМЫ
LINIOWE SYSTEMY FLUORESCENCYJNE



180-187
SUSPENDED
SUSPENDIDOS
SUSPENSIONS
HÄNGELEUCHTEN
SOSPENSIONI
SUSPENSÕES
ПОДВЕСНЫЕ
ZWIESZANE



188-195
SIGNAL
SEÑALIZACIÓN
SIGNALISATION
SIGNALISIERUNG
SEGNALETICA
SINALIZAÇÃO
МАРКЕРНАЯ ПОДСВЕТКА
SYGNALIZACJA



196-209
WALL FIXTURES
APLIQUES
APPLIQUES
WANDLEUCHTEN
APPLIQUE
APLIQUES
НАСТЕННЫЕ
KINKIETY



210-223
LED STRIPS
TIRAS LED
BANDEAUX À LED
LED-BÄNDER
STRISCE LED
FITAS LED
СВЕТОДИОДНЫЕ ЛЕНТЫ
PASKI LED

DECORATIVE

by LA CREU



226-271
FAMILIES
FAMILIAS
FAMILLES
FAMILIEN
FAMIGLIE
FAMILÍAS
СЕРИИ
RODZINY



272-341
DRESS UP



342-393
**WALL &
CEILING**
PAREDES Y TECHOS
MUR ET PLAFOND
WAND UND DECKE
PARETE E SOFFITTO
PAREDE E TECTO
НАСТЕННЫЕ И ПОТОЛОЧНЫЕ
KINKIETY I SUFITOWE



410-445
BATH
BAÑO
SALLE DE BAINS
BAD
BAGNO
CASA DE BANHO
ДЛЯ ВАННЫХ КОМНАТ
ŁAZIENKOWE



394-409
**DESK
& FLOOR**
SOBREMESAS Y PIES
BUREAU ET SOL
TISCH UND STEH
SCRIVANIA E PAVIMENTO
ESCRITÓRIOS E CHÃO
НАСТОЛЬНЫЕ ЛАМПЫ И
ТОРШЕРЫ
BIURKOWE I STOJĄCE



446-491
**CEILING
FANS**
VENTILADORES
VENTILATEURS DE PLAFOND
DECKENVENTILATOREN
VENTILATORI DA SOFFITTO
VENTILADORES DE TECTO
ВЕНТИЛЯТОРЫ
WENTYLATORY SUFITOWE

OUTDOOR

 494-523
WALL WASHERS & SPOTLIGHTS
BAÑADORES DE PARED
Y PROYECTORES
LÉCHE-MURS ET
PROJECTEURS ET SPOTS
WALL WASHER
UND STRAHLER
WALL WASHERS E PROIETTORI
WALL WASHERS E PROJECTORES
СВЕТОВАЯ ЗАЛИВКА СТЕН
И ПРОЖЕКТОРЫ
REFLEKTORY OPRAWY TYPU WALL
WASHERS

 524-593
WALL FIXTURES
APLIQUES
APPLIQUES
WANDELEUCHTEN
APPLIQUE
APLIQUES
НАСТЕННЫЕ
KINKIETY

 594-613
CEILING
TECHO
PLAFONNIERS
DECKENLEUCHTEN
PLAFONIERE
ТЕСТО
ПОТОЛОЧНЫЕ
SUFTOWE

 614-655
RECESSED
EMPOTRADOS
ENCASTRÉS
EINBAULEUCHTEN
INCASSI
ENCASTRÁVEIS
ВСТРАИВАЕМЫЕ
WPUSZCZANE

 656-661
SUBMERSIBLE
SUMERGIBLES
SUBMERSIBLES
VERSENKBARE LEUCHTEN
LUCI SOMMERGIBILI
SUBMERSÍVEIS
ПОГРУЖАЕМЫЕ В ВОДУ
ZANURZALNE

 662-673
CHILL-OUT
CHILLOUT
CHILLOUT
CHILLOUT-BELEUCHTUNG
CHILLOUT
CHILLOUT
ДЛЯ ЗОНЫ ОТДЫХА
CHILLOUT

 674-683
LANTERNS
SOBREMUIROS
BORNES
SOCKELLEUCHTEN
LANTERNE DA GIARDINO
SOBREMUIROS
ПАРКОВЫЕ СТОЛБЫ
LATARNIE

 684-719
BOLLARDS
BALIZAS
BALISES
POLLERLEUCHTEN
FARI
PIMENTEIROS
НАЗЕМНЫЕ СТОЛБЫ
SŁUPKI

 720-729
STREET LIGHTS
FAROLAS
RÉVERBÈRES
MASTLEUCHTEN
LAMPIONI
POSTES DE ILUMINAÇÃO
ФОНАРИ
LAMPY ULICZNE



730-807
URBAN LIGHTING
ILUMINACIÓN URBANA
ÉCLAIRAGE URBAIN
STRASSENLEUCHTEN
ILLUMINAZIONE URBANA
ILUMINAÇÃO PÚBLICA
ГОРОДСКОЕ ОСВЕЩЕНИЕ
OSWIETLENIE MIEJSKIE

EMOTIONAL

 838-839
DOTS
PUNTOS
POINTS LUMINEUX
PUNKTE
PUNTI
PONTOS
ТОЧКИ
PUNKTY

 840-841
FLEXIBLE CURTAINS
CORTINAS FLEXIBLES
RIDEAUX FLEXIBLES
FLEXIBLE VORHÄNGE
TENDE FLESSIBILI
CORTINAS FLEXÍVEIS
ГИБКИЕ ЗАНАВЕСЫ
ELASTYCZNE ZASŁONY

 842
OUTDOOR DISPLAY
PANTALLA EXTERIOR
ÉCRAN D'EXTÉRIEUR
AUSSEN DISPLAY
SCHERMO ESTERNO
ECRÀ EXTERIOR
ЭКРАНЫ ДЛЯ УЛИЧНОГО ПРИМЕНЕНИЯ
EKAN ZEWNETRZNY

 843
OUTDOOR TUBES
TUBOS EXTERIOR
TUBES D'EXTÉRIEUR
AUSSEN RÖHREN
TUBI ESTERNI
TUBOS DE EXTERIOR
СВЕТОДИОДНЫЕ ТРУБКИ ДЛЯ УЛИЧНОГО ПРИМЕНЕНИЯ
TUBY ZEWNETRZNE

 844-845
INDOOR DISPLAY
PANTALLA INTERIOR
ÉCRAN D'INTÉRIEUR
INNEN DISPLAY
SCHERMO INTERNO
ECRÀ DE INTERIOR
ЭКРАНЫ ДЛЯ ИНТЕРЬЕРА ПОМЕЩЕНИЙ
EKAN WEWNĘTRZNY

 846-847
LED FLOOR
SUELO LED
SOL LED
LED BODENEINBAU
PAVIMENTO LED
LED DE CHÃO
СВЕТОДИОДНЫЙ ПОЛ
PODŁOGA LED

 850-859
LAMPS
LÁMPARAS | LAMPES | LEUCHTMITTEL | LAMPADINE | LÂMPADAS | ЛАМПЫ | ZARÓWKI

 860-881
ELECTRICAL UNITS / ACCESSORIES
UNIDADES ELÉCTRICAS / ACCESORIOS | PLATINES ÉLECTRIQUES / ACCESSOIRES | NETZTEILE / ZUBEHÖRE | UNITÁ ELETTRICHE / ACCESSORI
UNIDADES ELÉTRICAS / ACESSÓRIOS | ЭЛЕКТРООБОРУДОВАНИЕ / АКЦЕСУАРЫ | CZĘŚCI ELEKTRYCZNE / AKCESORIA

TECHNICAL

PROYECTORES Y CARRILES | SPOTLIGHTS AND TRACKS | PROJECTEURS ET RAILS | STRAHLER UND SCHIENEN | PROIETTORI E BINARI | PROJETORES E CALHAS | ПРОЖЕКТОРЫ И ШИНОПРОВОДЫ | ПРОЈЕКТОРЫ | SZYNY



DOWNLIGHTS | DOWNLIGHTS | DOWNLIGHTS | DOWNLIGHTS | DOWNLIGHTS | DOWNLIGHTS | ПОТОЛОЧНЫЕ | ОПРАВЫ ТИПУ DOWNLIGHT

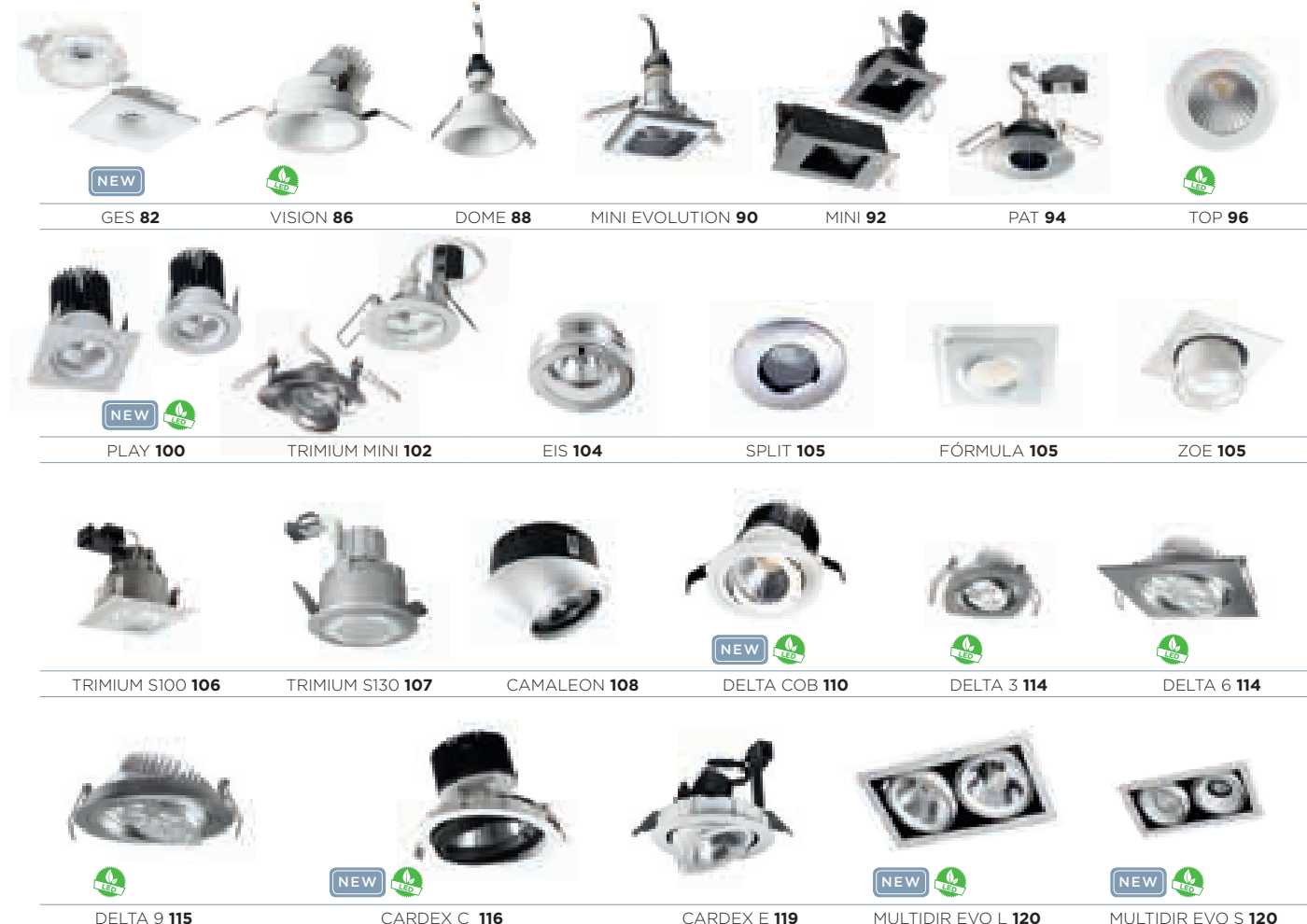

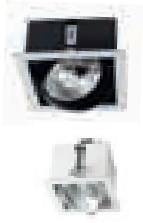

MULTIDIR 128



BACO 132



EXIT 136



ROUND FIT 140



EQUAL SPOT 142



EQUAL S 144, 146



EQUAL L 145, 147



ROL 148



ECO 152



ECOLED 153



DOWN 154



VOL 155



FIT 157



ECOFIT 159



FRAME 160



MINI FRAME 162



VITRO 166



SISTEMAS DE FLUORESCENCIA LINEAL | FLUORESCENT LINEAL LIGHTING SYSTEMS | SYSTÈMES À FLUORESCENCE LINÉAIRE | LINEALE LEUCHTSTOFFRÖHRENSYSTEME | SISTEMI DI FLUORESCENZA LINEARE | SISTEMAS LINEARES DE ILUMINAÇÃO FLUORESCENTE | ЛИНЕЙНЫЕ ЛЮМИНЕСЦЕНТНЫЕ СИСТЕМЫ | LINIOWE SYSTEMY FLUORESCENCYJNE



INFINITE 174

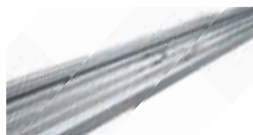

INFINITE C 171

TECHNICAL

SUSPENDIDOS | SUSPENDED | SUSPENSIONS | HÄNGELEUCHTEN | SOSPENSIONI | SUSPENSÕES | ПОДВЕШНЫЕ | ZWIESZANE



SEÑALIZACIÓN | SIGNAL | SIGNALISATION | SIGNALISIERUNG | SEGNALETICA | SINALIZAÇÃO | МАРКЕРНАЯ ПОДСВЕТКА | SYGNALIZACJA



APLIQUES | WALL FIXTURES | APPLIQUES | WANDLEUCHTEN | APPLIQUE | APLIQUES | НАСТЕННЫЕ | KINKIETY

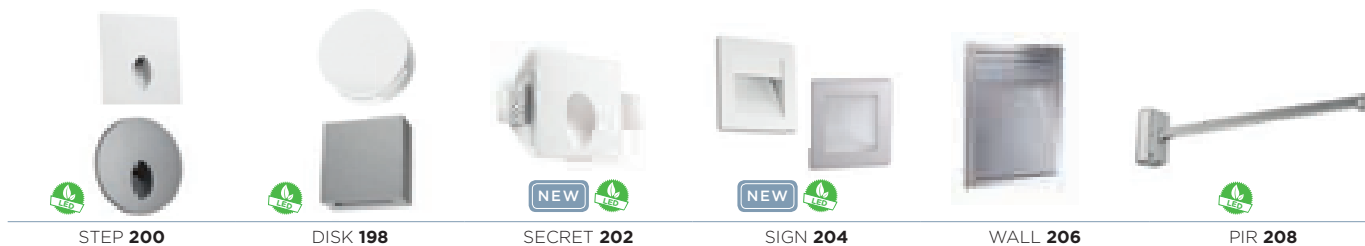



TIRAS LED | LED STRIPS | BANDEAUX À LED | LED-BÄNDER | STRISCE LED | FITAS LED |
СВЕТОДИОДНЫЕ ЛЕНТЫ | PASKI LED



ION **212**



NEW



ZENIT **213**



SIGMA **214**



NEW



RAND HIGH POWER **215**



RAND IP **216**



ON **217**



NEW



ON ECO **218**



NEW



ON HIGH POWER **219**



NEW



ON IP ECO **220**



NEW



FACADE **221**



LINEAL **223**

DECORATIVE

COLGANTES | PENDANTS | SUSPENSIONS | PENDELLEUCHTEN | PENDENTI | PENDENTS |
ПОДВЕСНЫЕ СВЕТИЛЬНИКИ | LAMPY WISZĄCE



CURL **226, 227**

ROAD **228, 229**

SVEN **230, 231**

BELL **232, 233**

ROCKET **234, 235**



PIPE **236**

BLIND **237**

DROP **238**

NIMES **239**

BUCKET **240, 241**

NEO **242, 243**



VINTAGE **244 - 247**

TRAMA **250**

CUMBIA **254**

MECANO **255**



MAGMA **256, 257**

VIRGINIA **260**

UP & DOWN **263**

FLORENCIA **264**



SAN FRANCISCO **265**

PROVENZA **266**

ALSACIA **267**

XENIA **271**

SPICA **334**



SPICA **336 - 338**

PLAFONES | CEILING FIXTURES | PLAFONIERS | DECKENLEUCHTEN | PLAFONIERE | PLAFONES |
 ПОТОЛОЧНЫЕ СВЕТИЛЬНИКИ | PLAFONIERY



PIPE **236**



TRAMA **251**



FLORENCIA **264**



ALSACIA **268**

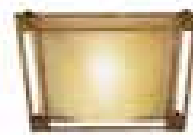

VERONESE **270**



NEW LED

SATURN **356 - 357**



SUNNY **374**



WOOD **380, 381**



NEW LED

TOLEDO **382, 383**



PRISMA **384, 385**



RAS **386 - 387**

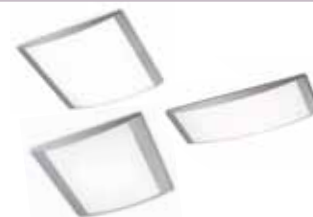

ALPEN **388, 389**



CLIP **390**



ROUND **391**



AUDREY **392**



OSLO **393**



NEW

FLOW **430, 431**



DEC **432**



PARMA **433**

























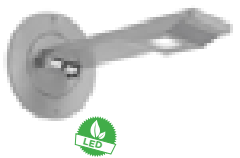































NEW

BOB **434, 435**

DECORATIVE

APLIQUES | WALL FIXTURES | APPLIQUES | WANDLEUCHTEN | LAMPADA DA PARETE | APLIQUES
 | НАСТЕННЫЕ СВЕТИЛЬНИКИ | LAMPY ŚCIENNE

 NEW 	 NEW 	 NEW				
CURL 226	ROAD 228, 229	PIPE 236	VINTAGE 247	TRAMA 252, 253	CUMBIA 254	ALSACIA 268, 269
		 	 	 		
VERONESE 270	XENIA 271	DIDO 342	ESTAK 343	ON-OFF 344		
 NEW 	 	 	 			
IVY 345	DRACO 346	BED 347	BOOK 348			
 	 	 NEW 	 NEW 	 		
WALL 348	LLIT 349	ROOMIE 350, 351	SIENA LED 352	SIENA 353		
 NEW 	 	 NEW 	 			
LIA LED 354, 355	SATURN 356, 357	KUB 358	JET 359			
 	 	 	  NEW			
BRICK 359	OVAL 360, 361	SPOT 362	GES 363			
						
GES 364, 365	LIA 366	NEMESIS 367	BREMEN 368			



HALF 369



PRACTIC 370

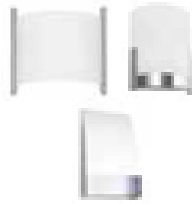

NIZA 371



LUGO 372



GLASS 373



SUNNY 374



ALU 375



MAKE UP 414



VESPA 376



NOK 377



TRINITY 378, 379



WOOD 380, 381



FLEX 394, 395



WAVE 397



PANTALLAS | SHADES | ABAT-JOUR | STOFFSCHIRME | PARALUME | АБАЖУР | АБАЖУРА | АБАЖУРЫ



VIRGINIA 261



TWIST 262



BALI 274 - 276



GLOSS 277 - 279



BRISTOL 280 - 282



TORINO 283-287



OXFORD 296

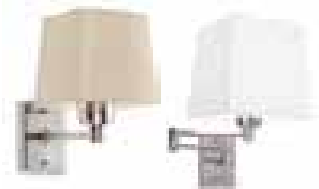

DOVER 297 - 301

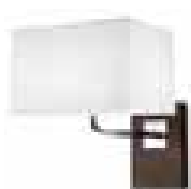

DEVON 305



MICHIGAN 308, 309



LYON 314, 315



FEI 320, 321



DENVER 328



SPICA 332



BALMORAL 340



TYRA 341



BROOKLYN 341

DECORATIVE

BAÑO | BATH | SALLE DE BAINS | BAD | BAGNO | CASA DE BANHO |
 ДЛЯ ВАННЫХ КОМНАТ | ŁAZIENKOWE

IP



CONCEPT 412



BELYSA 413



SKARA 415



TOILET 416, 417



TOILET Q 418, 419



DRESDE 420, 421



DRESDE EVO 422, 423



DRESDE ON 424



BATH 424



ORION 425

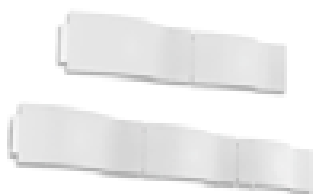

ONDA 426, 427



LORIENT 428, 429



FLOW 430, 431



DEC 432



PARMA 433



BOB 434, 435



GLANZ 442, 443



REFLEX 444

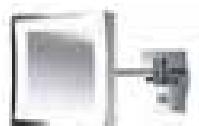

VANITY 445

EMPOTRABLES | DOWNLIGHTS | ENCASTRÉS | EINBAULEUCHTEN | ILLUMINAZIONE DA INCASSO | ENCASTRÁVEIS | ВСТРОЕННЫЕ ПОТОЛОЧНЫЕ | DOWNLIGHTY

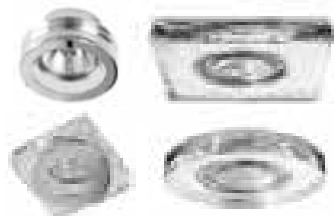

EIS 436, 437



FÓRMULA 438, 439



SPLIT 440, 441

SOBREMESAS | TABLE LAMPS | LAMPES DE TABLE | TISCHLEUCHTEN | DA TAVOLO | CANDEEIROS DE MESA |
 НАСТОЛЬНЫЕ СВЕТИЛЬНИКИ | LAMPY STOŁOWE



DECORATIVE

PIES DE SALÓN | FLOOR LAMPS | LAMPADAIRES | STEHLEUCHTEN | PIEDISTALLO DA SALONE | CANDEEIROS DE SALA |
ТОРШЕРЫ | LAMPY PODŁOGOWE



VINTAGE 248, 249

TRAMA 251

MAGMA 258, 259



VIRGINIA 260

TWIST 262

ALSACIA 268, 269

TORINO 292 - 295

DOVER 304, 305

DEVON 307

MICHIGAN 312, 313



LYON 318, 319

FEI 325

MILAN 327

DENVER 329

SPICA 339

VINTAGE 396

QUEEN 398, 399

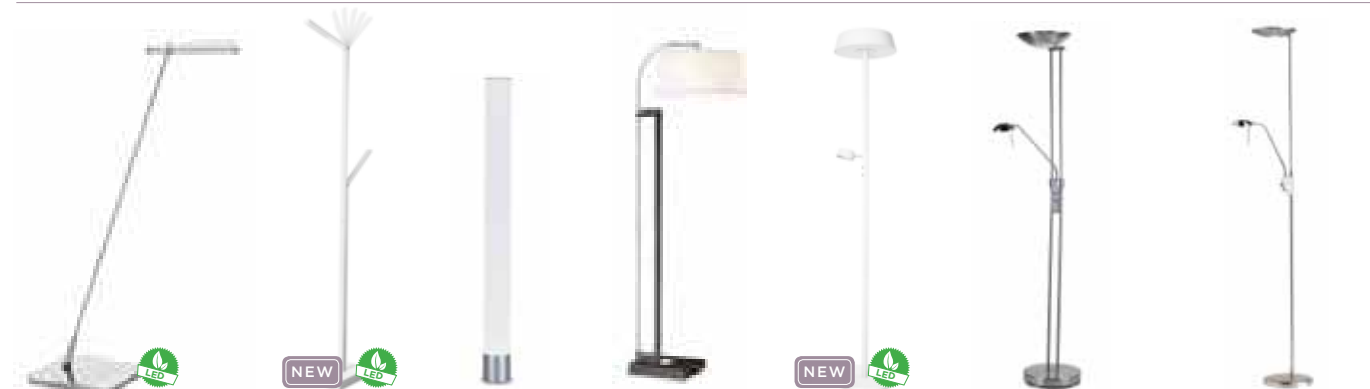

ELVA 398, 399

JAZZ 402, 403

ABERDEEN 404

EXTEND 405

PING 406

CRETA 406

MEMPHIS 408, 409



CEILING FANS

VENTILADORES | VENTILATEURS | DE PLAFOND | DECKENVENTILATOREN | VENTILATORI DA SOFFITTO | VENTILADORES DE TECTO | ВЕНТИЛЯТОРЫ | WENTYLATORY SUFITOWE

S PEQUEÑO | SMALL | PETITE | KLEIN | PICCOLA | PEQUENO | МАЛЕНЬКАЯ | MAŁY



BORACAY 491



BOUVET 486, 487



M MEDIANA | MEDIUM | MOYENNE | MITTEL | MEDIA | MÉDIO | СРЕДНЯЯ | ŚREDNI



BORNEO 482, 483



CORON 490

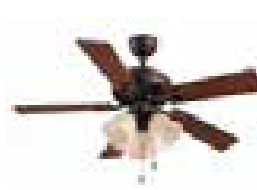

DOMINICA 484, 485

L GRANDE | LARGE | GRANDE | GROSS | GRANDE | GRANDE | БОЛЬШОЙ | DUŻY



AUKENA 458, 459



BAGUR 470, 471



BAHIA 466, 467

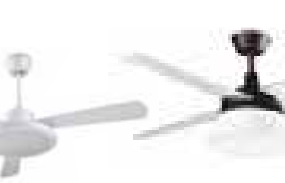

BANUS 472, 473



BELMONT 476, 477



NEW



CEOS 452, 453

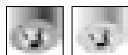

FORMENTERA 460, 461

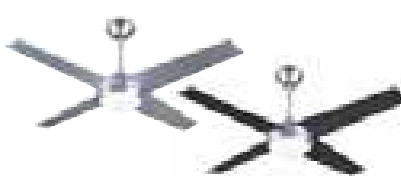

HAWAI 462, 463



JUNCAL 488



MAURITIUS 489



MOGAN 480, 481



PHUKET 478, 479



RODAS 456, 457



SAMAL 464, 465



NEW



TIGA 448, 449



TORONTO 474, 475



TUPAI 454, 455



TWENTY 468, 469



NEW

VINTAGE 450, 451

OUTDOOR

APLIQUES | WALL FIXTURES | APPLIQUES | WANDLEUCHTEN | APPLIQUE | APLIQUES | НАСТЕННЫЕ | KINKIETY



CURIE 525 ACCESS 527 PIRAMID 527 AFRODITA 529,533-535,541,549 FENIX 529 WILSON 531



POKER 531 NEMESIS 537,539,547,551 TINA 541 DELFOS 543 NEO 545 GALILEI 547 ATENA 547



NAPOLI 547 TERRY 549 TEMIS 549 MERTON 551 SELENE 551 LOTTERY 553 LUA 553



PILE 553 PASTEUR 553 TAYLOR 555, 557 ALVIN 555 ANGLE 555 CLOUS 557 KARMAN 557



CUBUS 559 VELTMAN 559 ICARO 559 SURF 561 ALFA 561 MICENAS 563 KÖSSEL 563

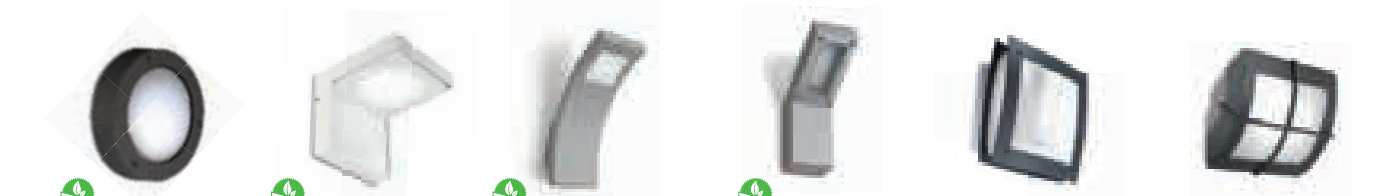

GAP 563 CORNER 565 SHARPE 565 WALKER 565 DARWIN 567 WINDOWS 567



ECLIPSE 567



OPAL 569



BASIC 569



ECLIPSE 569



MANDELA 571



HEBE 571



SUZUKI 571



SIMS 571



NEW

PRIAP 573



ELECTRA 573



EDWARDS 575



NEW

MONACO 575



NEREO 575



AJAX 577



NEW

TREBBIN 577



NEW

VINTAGE 579



SOPHIE 579



NEW

MARK 581



THOMAS 581



ALBA 583, 589



AJAX 583



OCEANO 583



PERSEO 583



CIRI 585



REED 585



LED

JANNA 587



ODISEO 587



EDIPO 587



PERSEFONE 589



OCEANO 589



CROSS 591



ITACA 591



TRITON 591



SIRENA 591



NEW

ANDREA 593



GALATEA 593



MORFEO 593

OUTDOOR

BAÑADORES DE PARED | WALL WASHERS | LÈCHE-MURS | WANDBELEUCHTUNG | WALL WASHERS |
 PROJETORES WALL WASHER | НАСТЕННЫЕ КОСТЮМЫ | OPRAWY TYPU WALL WASHERS



PROYECTORES | SPOTLIGHTS | PROJECTEURS ET SPOTS | STRAHLER | RIFLETTORI | PROJECTORES |
 ПРОЖЕКТОРЫ | SPOTLIGHTY



PLAFONES | CEILING FIXTURES | PLAFONNIERS | DECKENLEUCHTEN | PLAFONIERE | TECTOS |
ПОТОЛОЧНЫЕ СВЕТИЛЬНИКИ | OPRAWY SUFITOWE



AFRODITA **595, 599**



JEP **597**



LEGETT **597**



KÖSSEL **597**



COSMOS **601**



SELENE **601**



OPAL **603**



BASIC **605**



MARK **607**



ALBA **607**



SIMS **607**



ECLIPSE **607**

COLGANTES | PENDANTS | SUSPENSIONS | HÄNGELEUCHTEN | LAMPAD E A SOSPENSIONE | PENDENTES |
ПОДВЕСНЫЕ СВЕТИЛЬНИКИ | OPRAWY WISZĄCE



KAP **609**



NEW

JAMBO **609**



NEW

MARK **609**



NEW

JANNA **611**



ALBA **611**



CROSS **611**



NEW

ANDREA **613**



GALATEA **613**

OUTDOOR

 SOBREMUIROS | LANTERNS | BORNES | MAUERLEUCHTEN | LANTERNE DA GIARDINO | SOBREMUIROS | ПАРКОВЫЕ СТОЛБЫ | LATARNIE



 BALIZAS | BOLLARDS | BALISES | POLLER | FARI | PIMENTEIROS | НАЗЕМНЫЕ СТОЛБЫ | SŁUPKI

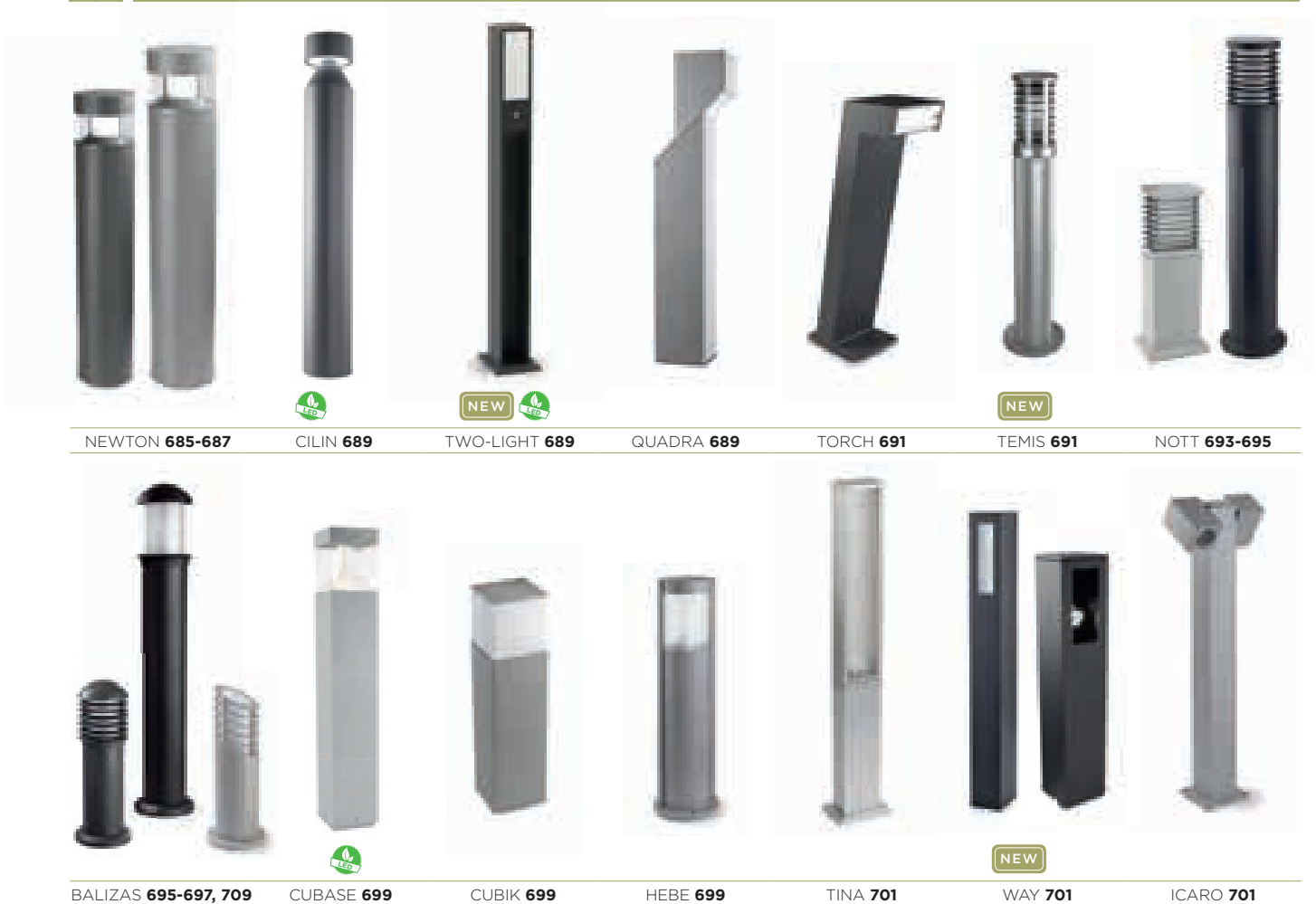



MÜLLER 703

PILE 705

SHARPE 705

WALKER 705

TAUBE 707

NEW
BEUTLER 707

NEW
HELION 707



NEW

MARK 709

SIMS 709

MANDELA 711

SUZUKI 711

NEW

PRIAP 713

EDWARDS 715



ALEXANDRIA 715

ELECTRA 717

EVANS 719

ALBA 719

MIDAS 719

CROSS 719

OUTDOOR



EMBOTRADOS | RECESSED | ENCASTRÉS | EINBAULEUCHTEN | INCASSI | ENCASTRÁVEIS |
ВСТРАИВАЕМЫЕ | WPUSZCZANE



GEA 615-617

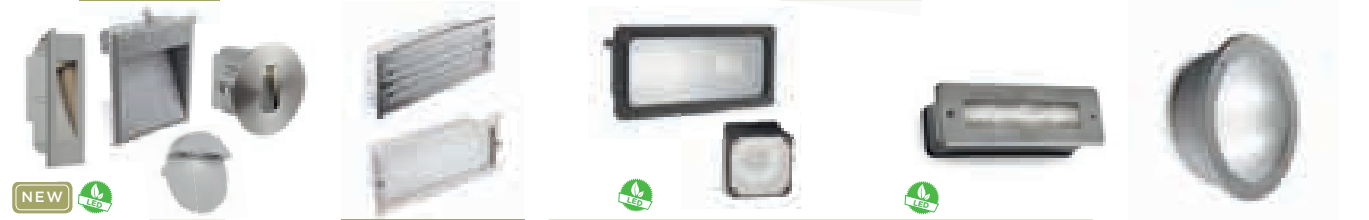

NEW LED

MICENAS 619, 621, 625, 627

HERCULES 619, 621

NEW LED

BASIC 619, 623

NEW LED

GEA 621

DALTON 627



NEW LED

GEA 629-649



NEW LED

XENA 651-655

NEW LED

REXEL 655



SUMERGIBLES | SUBMERSIBLE | SUBMERSIBLES | VERSENKBARE LEUCHTEN | LUCI SOMMERGIBILI | SUBMERSIVEIS |
ПОГРУЖАЕМЫЕ В ВОДУ | ZANURZALNE



NEW LED

AQUA 657-661



CHILLOUT | CHILL-OUT | CHILLOUT | CHILLOUT-BELEUCHTUNG | CHILLOUT | CHILLOUT |
 ДЛЯ ЗОНЫ ОТДЫХА | CHILLOUT



NEW LED SUN

ARI 663



NEW LED

CISNE 663



NEW LED

ROCK 665



KAP 667



NEW LED

INVISIBLE 669



NEW

JAMBO 669



NEW LED

MOONLIGHT 671

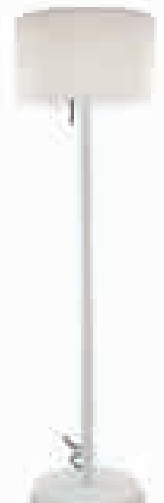
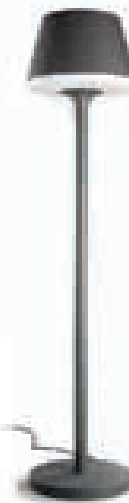

LED

SMOOTH 673



FAROLAS | STREET LIGHTS | RÉVERBÈRES | MASTLEUCHTEN | LAMPIONI | POSTES DE ILUMINAÇÃO |
 ФОНАРИ | LAMPY ULICZNE



LYON 721

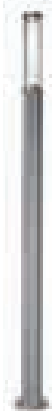

TEMIS 721-723

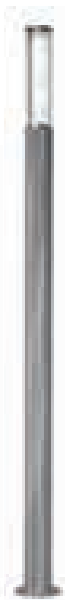
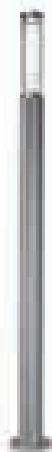

HEADS 725, 727



POMPEYA 725



GALATEA 728



















NEW ANDREA 729



OUTDOOR

URBAN LIGHTING ILUMINACIÓN URBANA | ÉCLAIRAGE URBAIN | URBANE BELEUCHTUNG | ILLUMINAZIONE URBANA | ILUMINAÇÃO PÚBLICA | ГОРОДСКОЕ ОСВЕЩЕНИЕ | OŚWIETLENIE MIEJSKIE

				
ESENCIAL LED 731 SOLAR 731	ESENCIAL HP LED 733	GAVINA LED 737 HID 739	ELIPSE LED 743 SOLAR 743 HID 745	
				
MINI ROADWAY HID 749	ROADWAY HID 751	ECOVIAL HID 755	PROMENADE LED 759 FLUO 759 HID 760	PIILED LED 763
				
CITIZEN LED 767 HID 769-771	MERIDIAN LED 773 SOLAR 777 HID 775-776	BOHEMIA LED 779 SOLAR 783 HID 781-782	ANDALUCÍA LED 785 SOLAR 789 HID 787-788	NEOBOLA LED 791 SOLAR 795 HID 793-794
				
LED KIT 797	SOLAR-ECO KIT 798	SOLAR-TECH KIT 799	COLUMNS 800-806	ARMS&BRACKETS 807

EMOTIONAL



DOTS **838**

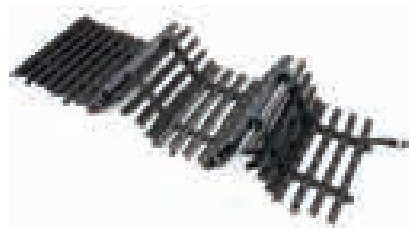

FLEXIBLE CURTAINS **840**



OUTDOOR DISPLAY **842**



OUTDOOR TUBES **843**

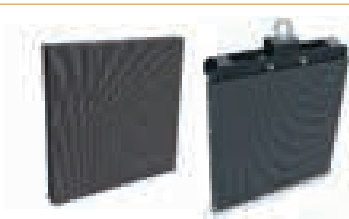

INDOOR DISPLAY **844**

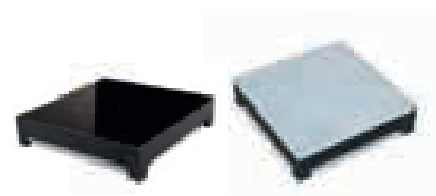

LED FLOOR **846**

P 850-859

LAMPS



LÁMPARAS | LAMPES | LEUCHTMITTEL | LAMPADINE | LÂMPADAS |
ЛАМПЫ | ŻARÓWKI

P 860-889

ELECTRICAL UNITS ACCESSORIES



UNIDADES ELÉCTRICAS / ACCESORIOS | PLATINES ÉLECTRIQUES / ACCESSOIRES | NETZTEILE / ZUBEHÖRE | UNITÀ ELETTRICHE /
ACCESSORI | UNIDADES ELÉTRICAS / ACESSÓRIOS | ЭЛЕКТРОБОРУДОВАНИЕ / АКСССУАРЫ | CZĘŚCI ELEKTRYCZNE / AKCESORIA



TECHNICAL
44-223

DECORATIVE
224-491

446-491
CEILING FANS

OUTDOOR
492-807

730-807
URBAN

EMOTIONAL
808-849



TECHNICAL



46-77 SPOTLIGHTS AND TRACKS

PROYECTORES Y CARRILES
PROJECTEURS ET RAILS
STRAHLER UND SCHIENEN
PROIETTORI E BINARI
PROJETORES E CALHAS
ПРОЖЕКТОРЫ И ШИНОПРОВОДЫ
PROJEKTORY I SZYNY



78-167 DOWNLIGHTS

DOWNLIGHTS
DOWNLIGHTS
DOWNLIGHTS
DOWNLIGHTS
DOWNLIGHTS
ПОТОЛОЧНЫЕ
OPRAWY TYPU DOWNLIGHT



168-179 FLUORESCENT LINEAL LIGHTING SYSTEMS

SISTEMAS DE FLUORESCENCIA LINEAL
SYSTÈMES À FLUORESCENCE LINÉAIRE
LINEALE LEUCHTSTOFFRÖHRENSYSTEME
SISTEMI DI FLUORESCENZA LINEARE
SISTEMAS LINEARES DE ILUMINAÇÃO
FLUORESCENTE
ЛИНЕЙНЫЕ ЛЮМИНЕСЦЕНТНЫЕ СИСТЕМЫ
LINIOWE SYSTEMY FLUORESCENCYJNE



180-187 SUSPENDED

SUSPENDIDOS
SUSPENSIONS
HÄNGELEUCHTEN
SOSPENSIONI
SUSPENSÕES
ПОДВЕЧНЫЕ
ZWIEŠZANE



188-195 SIGNAL

SEÑALIZACIÓN
SIGNALISATION
SIGNALISIERUNG
SEGNALETICA
SINALIZAÇÃO
МАРКЕРНАЯ ПОДСВЕТКА
SYGNALIZACJA



196-209 WALL FIXTURES

APLIQUES
APPLIQUES
WANDLEUCHTEN
APPLIQUE
APLIQUES
НАСТЕННЫЕ
KINKIETY



210-223 LED STRIPS

TIRAS LED
BANDEAUX À LED
LED-BÄNDER
STRISCE LED
FITAS LED
СВЕТОДИОДНЫЕ ЛЕНТЫ
PASKI LED

TECHNICAL

BOND TUBE 

BOND 

VIAX











P. 48



P. 54



P. 60

			■			■
			■			■
			■	■		■
	14		■	■		■
	N3					■
	60					■
QR-111/G53			■	■		■
CDM-R111/GX8.5	35W		■	■		■
CDM-R111/GX8.5	70W		■	■		■
HIT-T/G12	35W		■	■		■
HIT-T/G12	70W		■	■		■
HIT-T/G12	100W					■
HIT-T/G12	150W					
HCI-TF/GU6.5	35W			■		
CDM-TM/PGJ5	20W					
CDM-TM/PGJ5	35W					
AR-111/GU10	-		■	■		■
QPAR-16/GU10	-					
LED Zhaga	2000lm		■	■		
LED Zhaga	3000lm		■	■		
LED Zhaga 220-240V	2000lm		■	■		
	10°		■	■		■
	12°					
	15°		■	■		
	24°		■	■		■
	36°		■	■		
	38°					
	45°		■	■		■
			■	■(1)		■



SPOTLIGHTS AND TRACKS

PROYECTORES Y CARRILES
PROJECTEURS ET RAILS
STRAHLER UND SCHIENEN
PROIETTORI E BINARI
PROJETORES E CALHAS
ПРОЖЕКТОРЫ И ШИНОПРОВОДЫ
PROJEKTORY I SZYNY

ACTION 



P. 66

KEY



P. 72

MACH1



P. 74

■	■	■
	■	■
	■	■
■	■	
■	■	■
■	■	
■	■	
■		■
■		■
■		
■		■
■	■	■
■	■	
■		
■		■
■		■
■		■
■		■
■	■	■

(1) Sólo en algunas versiones / Only in some versions

BOND TUBE





BOND TUBE

NEW

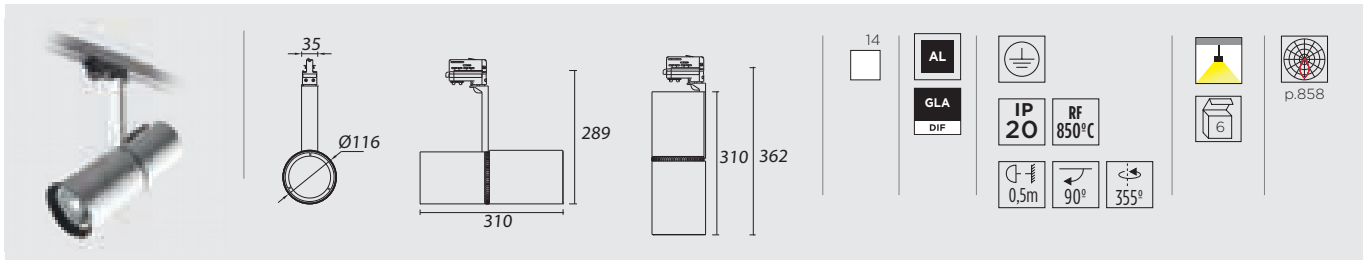

LED

<p>Estándar Zhaga / Zhaga Standard</p>	35-3561-14-37	<input type="checkbox"/>	2000 lm ^(N)	3000K	CRI>80	15°	26W	<p>220V 240V</p>
	35-3562-14-37	<input type="checkbox"/>				24°		
	35-3563-14-37	<input type="checkbox"/>				36°		
	35-3564-14-37	<input type="checkbox"/>				15°		
	35-3565-14-37	<input type="checkbox"/>				24°		
	35-3566-14-37	<input type="checkbox"/>				36°		
	35-3567-14-37	<input type="checkbox"/>		3000K	CRI>90	15°	23W	
	35-3568-14-37	<input type="checkbox"/>				24°		
	35-3569-14-37	<input type="checkbox"/>				36°		
	35-3570-14-37	<input type="checkbox"/>		3000K	CRI>80	15°	28W	
	35-3571-14-37	<input type="checkbox"/>				24°		
	35-3572-14-37	<input type="checkbox"/>				36°		
	35-3573-14-37	<input type="checkbox"/>				15°		
	35-3574-14-37	<input type="checkbox"/>				24°		
	35-3575-14-37	<input type="checkbox"/>				36°		
	35-3576-14-37	<input type="checkbox"/>		3000K	CRI>90	15°	33W	
	35-3577-14-37	<input type="checkbox"/>				24°		
	35-3578-14-37	<input type="checkbox"/>				36°		

QR-111 / AR-111

G53 (max. H=100 mm)	35-3554-14-00	<input type="checkbox"/>	max.100W	220V 240V	09-14
----------------------------	----------------------	--------------------------	----------	--------------	-------

HIT-T G12 70W 10°

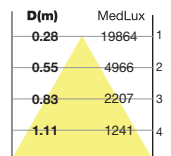
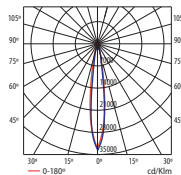

η=70%

CDM-R111

GX8.5 	35-3551-14-00	<input type="checkbox"/>	35W	220V 240V	15-20
	35-3552-14-00	<input type="checkbox"/>	70W		

HIT-T G12 70W 24°

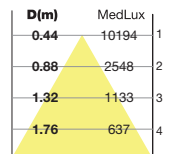
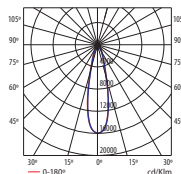

η=64%

HIT-T

G12 	35-3555-14-37	<input type="checkbox"/>	35W	220V 240V	10°	
	35-3556-14-37	<input type="checkbox"/>			24°	
	35-3557-14-37	<input type="checkbox"/>			45°	
	35-3558-14-37	<input type="checkbox"/>			70W	10°
	35-3559-14-37	<input type="checkbox"/>				24°
	35-3560-14-37	<input type="checkbox"/>				45°

HIT-T G12 70W 45°

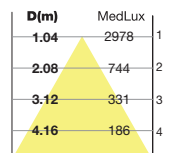
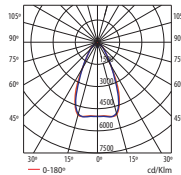

η=65%

AR-111

GU10 (max. H=100 mm)	35-3553-14-00	<input type="checkbox"/>	-	-	110V 240V	22-25
-----------------------------	----------------------	--------------------------	---	---	--------------	-------

Accesorios / Accessories / Accessoires / Zubehöre / Accessori / Acessórios / Аксессуары / Аксесорія

ACT-9127-11-00 HIT-T
ACT-9131-11-00 QR-111

ACT-9127-25-00 HIT-T
ACT-9131-25-00 QR-111

ACT-9135-60-00 HIT-T

ACT-9127-08-00 HIT-T
ACT-9131-08-00 QR-111

ACT-9127-24-00 HIT-T
ACT-9131-24-00 QR-111

BOND TUBE

NEW

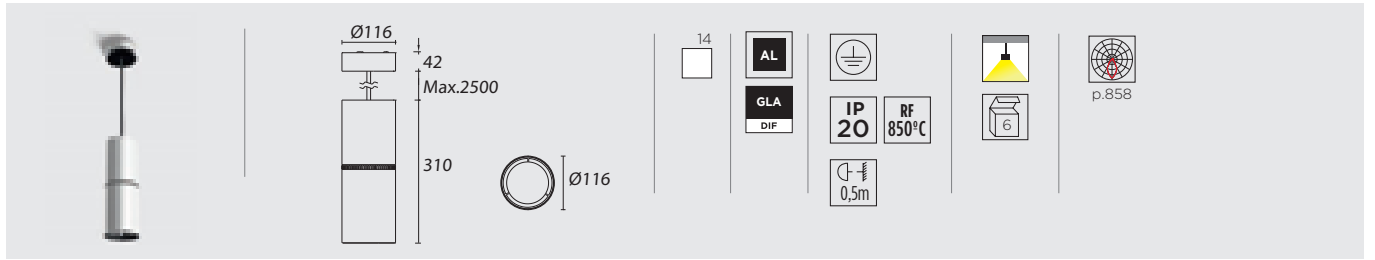

LED

<p>Estándar Zhaga / Zhaga Standard</p>	35-3621-14-37	<input type="checkbox"/>	2000 lm ^(N)	3000K	CRI>80	15°	26W
	35-3622-14-37	<input type="checkbox"/>				24°	
	35-3623-14-37	<input type="checkbox"/>				36°	
	35-3624-14-37	<input type="checkbox"/>				15°	
	35-3625-14-37	<input type="checkbox"/>				24°	
	35-3626-14-37	<input type="checkbox"/>				36°	
	35-3628-14-37	<input type="checkbox"/>	3000K	CRI>90	15°	23W	
	35-3629-14-37	<input type="checkbox"/>			24°		
	35-3630-14-37	<input type="checkbox"/>			36°		
	35-3631-14-37	<input type="checkbox"/>	3000 lm ^(N)	3000K	CRI>80	15°	28W
	35-3632-14-37	<input type="checkbox"/>				24°	
	35-3633-14-37	<input type="checkbox"/>				36°	
	35-3634-14-37	<input type="checkbox"/>				15°	
	35-3635-14-37	<input type="checkbox"/>				24°	
	35-3636-14-37	<input type="checkbox"/>				36°	
	35-3637-14-37	<input type="checkbox"/>	3000K	CRI>90	15°	33W	
	35-3638-14-37	<input type="checkbox"/>			24°		
	35-3639-14-37	<input type="checkbox"/>			36°		



QR-111 / AR-111

G53	35-3612-14-00	<input type="checkbox"/>	max.100W	220V 240V	09-14
-----	----------------------	--------------------------	----------	-----------	-------

(max. H=100 mm)

CDM-R111

GX8.5	35-3607-14-00	<input type="checkbox"/>	35W	220V 240V	15-20
	35-3608-14-00	<input type="checkbox"/>	70W		

HIT-T

G12	35-3613-14-37	<input type="checkbox"/>	35W	220V 240V	10°
	35-3614-14-37	<input type="checkbox"/>			24°
	35-3616-14-37	<input type="checkbox"/>			45°
	35-3617-14-37	<input type="checkbox"/>	70W		10°
	35-3618-14-37	<input type="checkbox"/>			24°
	35-3619-14-37	<input type="checkbox"/>			45°

AR-111

GU10	35-3611-14-00	<input type="checkbox"/>	-	-	110V 240V	22-25
------	----------------------	--------------------------	---	---	-----------	-------

(max. H=100 mm)

HIT-T G12 70W 10°

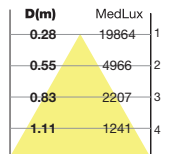
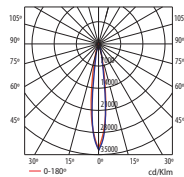

η=70%

HIT-T G12 70W 24°

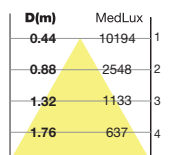
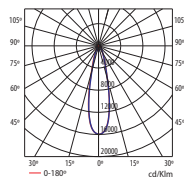

η=64%

HIT-T G12 70W 45°

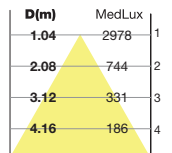
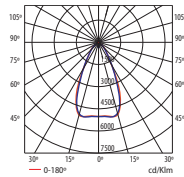

η=65%

Accesorios / Accessories / Accessoires / Zubehöre / Accessori / Acessórios / Аксессуары / Akcesoria

ACT-9127-11-00 HIT-T

ACT-9131-11-00 QR-111

ACT-9127-25-00 HIT-T

ACT-9131-25-00 QR-111

ACT-9135-60-00 HIT-T

ACT-9127-08-00 HIT-T

ACT-9131-08-00 QR-111

ACT-9127-24-00 HIT-T

ACT-9131-24-00 QR-111



BOND TUBE

NEW

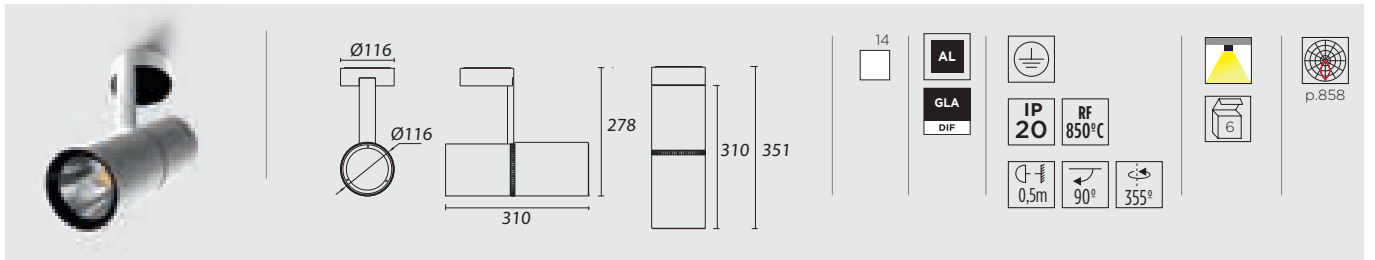

LED

Estándar
Zhaga /
Zhaga
Standard

<input type="checkbox"/>	35-3589-14-37	<input type="checkbox"/>				15°		
<input type="checkbox"/>	35-3590-14-37	<input type="checkbox"/>			3000K	24°	26W	
<input type="checkbox"/>	35-3591-14-37	<input type="checkbox"/>			CRI>80	36°		
<input type="checkbox"/>	35-3592-14-37	<input type="checkbox"/>				15°		
<input type="checkbox"/>	35-3593-14-37	<input type="checkbox"/>	2000 lm ^(N)	4000K		24°	24W	
<input type="checkbox"/>	35-3594-14-37	<input type="checkbox"/>				36°		
<input type="checkbox"/>	35-3595-14-37	<input type="checkbox"/>			3000K	15°		
<input type="checkbox"/>	35-3596-14-37	<input type="checkbox"/>				CRI>90	24°	23W
<input type="checkbox"/>	35-3597-14-37	<input type="checkbox"/>				36°		
<input type="checkbox"/>	35-3598-14-37	<input type="checkbox"/>			3000K	15°		
<input type="checkbox"/>	35-3599-14-37	<input type="checkbox"/>				CRI>80	24°	28W
<input type="checkbox"/>	35-3600-14-37	<input type="checkbox"/>				36°		
<input type="checkbox"/>	35-3601-14-37	<input type="checkbox"/>			3000 lm ^(N)	15°		
<input type="checkbox"/>	35-3602-14-37	<input type="checkbox"/>		4000K		CRI>80	24°	26W
<input type="checkbox"/>	35-3603-14-37	<input type="checkbox"/>				36°		
<input type="checkbox"/>	35-3604-14-37	<input type="checkbox"/>			3000K	15°		
<input type="checkbox"/>	35-3605-14-37	<input type="checkbox"/>				CRI>90	24°	33W
<input type="checkbox"/>	35-3606-14-37	<input type="checkbox"/>				36°		



QR-111 / AR-111



(max. H=100 mm)

<input type="checkbox"/>	35-3582-14-00	<input type="checkbox"/>	max.100W		
--------------------------	----------------------	--------------------------	----------	--	--

HIT-T G12 70W 10°

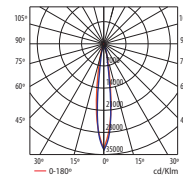

η=70%

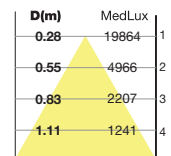

CDM-R111



<input type="checkbox"/>	35-3579-14-00	<input type="checkbox"/>	35W		
<input type="checkbox"/>	35-3580-14-00	<input type="checkbox"/>	70W		

HIT-T G12 70W 24°

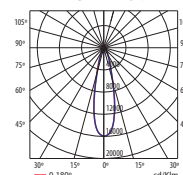

η=64%

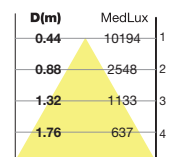

HIT-T



<input type="checkbox"/>	35-3583-14-37	<input type="checkbox"/>	35W		10°
<input type="checkbox"/>	35-3584-14-37	<input type="checkbox"/>			24°
<input type="checkbox"/>	35-3585-14-37	<input type="checkbox"/>			45°
<input type="checkbox"/>	35-3586-14-37	<input type="checkbox"/>	70W		10°
<input type="checkbox"/>	35-3587-14-37	<input type="checkbox"/>			24°
<input type="checkbox"/>	35-3588-14-37	<input type="checkbox"/>			45°

HIT-T G12 70W 45°

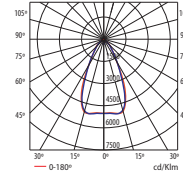

η=65%

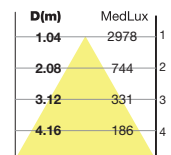

AR-111



(max. H=100 mm)

<input type="checkbox"/>	35-3581-14-00	<input type="checkbox"/>	-		
--------------------------	----------------------	--------------------------	---	--	--

Accesorios / Accessoires / Accessoires / Zubehöre / Accessori / Acessórios / Аксессуары / Akcesoria

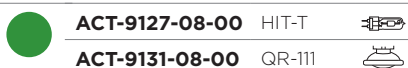
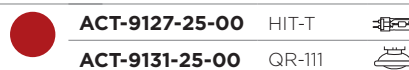

BOND



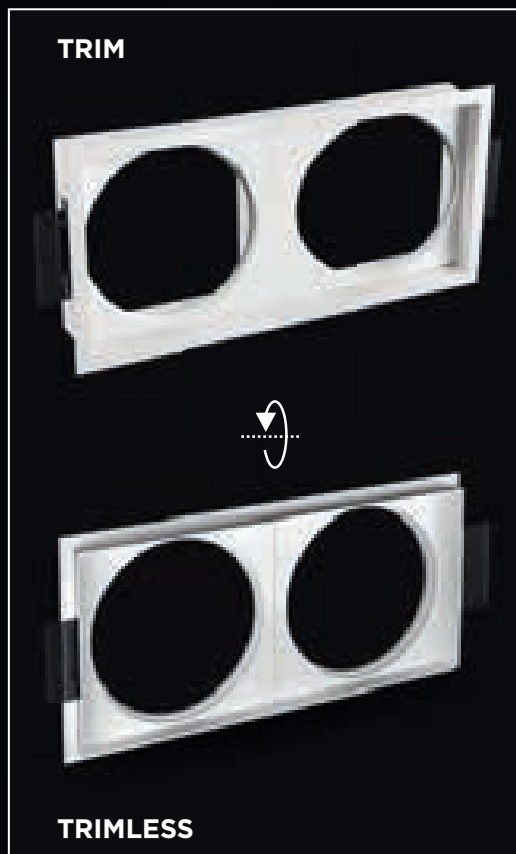





BOND

NEW

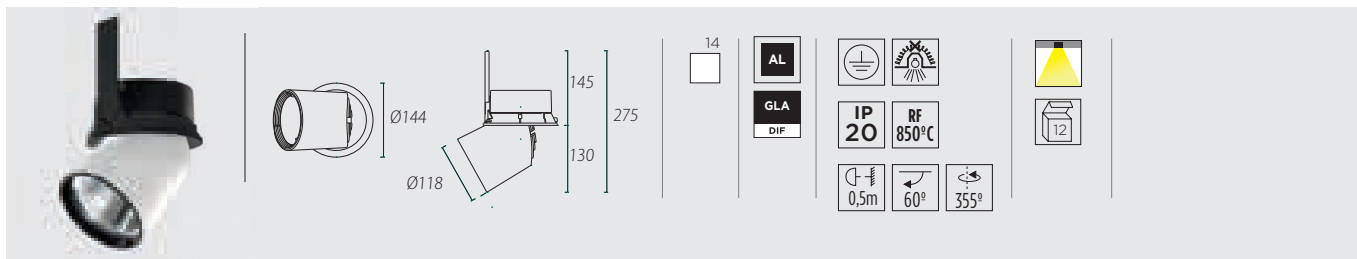

LED

Estándar
Zhaga /
Zhaga
Standard

<input type="checkbox"/>	90-2520-14-37	<input type="checkbox"/>	2000 lm ^(N)	3000K	CRI>80	15°	26W		
<input type="checkbox"/>	90-2521-14-37	<input type="checkbox"/>				24°			
<input type="checkbox"/>	90-2522-14-37	<input type="checkbox"/>	4000K	CRI>80	36°	24W			
<input type="checkbox"/>	90-2534-14-37	<input type="checkbox"/>			15°				
<input type="checkbox"/>	90-2556-14-37	<input type="checkbox"/>	3000K	CRI>90	24°	23W			
<input type="checkbox"/>	90-2581-14-37	<input type="checkbox"/>			36°				
<input type="checkbox"/>	90-2614-14-37	<input type="checkbox"/>	3000 lm ^(N)	3000K	CRI>80	15°	28W		
<input type="checkbox"/>	90-2615-14-37	<input type="checkbox"/>				24°			
<input type="checkbox"/>	90-2616-14-37	<input type="checkbox"/>	4000K	CRI>80	36°	26W			
<input type="checkbox"/>	90-2582-14-37	<input type="checkbox"/>			15°				
<input type="checkbox"/>	90-2594-14-37	<input type="checkbox"/>	3000K	CRI>90	24°	33W			
<input type="checkbox"/>	90-2599-14-37	<input type="checkbox"/>			36°				
<input type="checkbox"/>	90-2605-14-37	<input type="checkbox"/>	4000K	CRI>90	15°	26W			
<input type="checkbox"/>	90-2611-14-37	<input type="checkbox"/>			24°				
<input type="checkbox"/>	90-2613-14-37	<input type="checkbox"/>	3000K	CRI>90	36°	33W			
<input type="checkbox"/>	90-3512-14-37	<input type="checkbox"/>			15°				
<input type="checkbox"/>	90-3513-14-37	<input type="checkbox"/>	4000K	CRI>90	24°	26W			
<input type="checkbox"/>	90-3514-14-37	<input type="checkbox"/>			36°				

LED 2000lm 15° 3000K

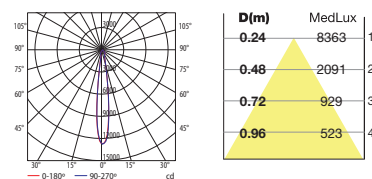

LED 2000lm 24° 3000K

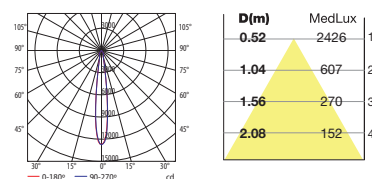

LED 2000lm 36° 3000K

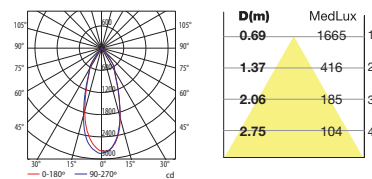

Equipos / Gears / Dispositifs/ Treiber / Dispositivi / Equipamentos / Устройства / Osprzet



71-2476-00-00	1 driver = 1 Bond	Driver ON / OFF 220-240 VAC	32 x 46 x 190 mm
----------------------	-----------------------------	--------------------------------	------------------

LED 3000lm 24° 3000K

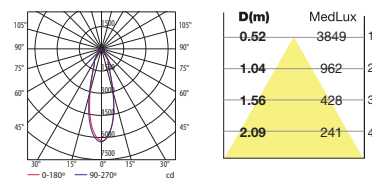

LED 3000lm 36° 3000K

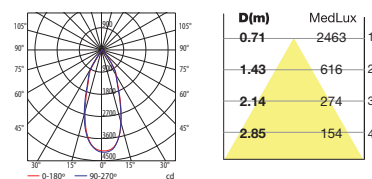

Accesorios / Accessories / Accessoires / Zubehöre / Accessori / Acessórios / Аксессуары / Akcesoria

- ACT-9127-11-00** LED
- ACT-9127-08-00** LED
- ACT-9127-25-00** LED
- ACT-9127-24-00** LED
- ACT-9135-60-00** LED

BOND

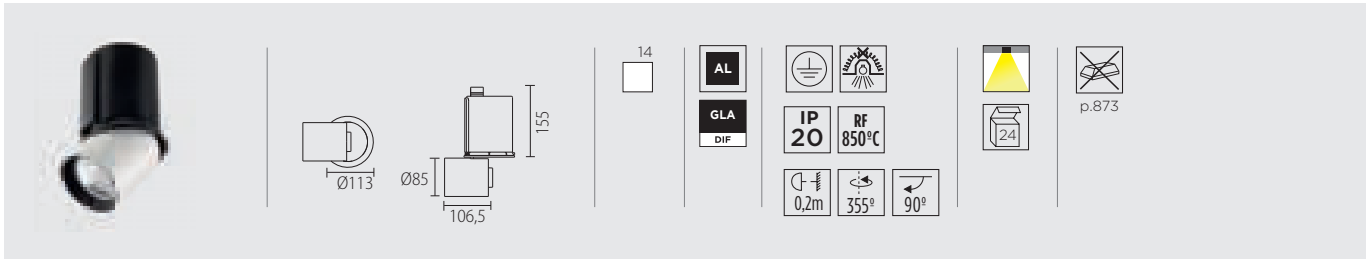

HCI-TF

GU6.5



71-1933-14-37	<input type="checkbox"/>	max.35W		10°
71-1539-14-37	<input type="checkbox"/>			24°
71-1934-14-37	<input type="checkbox"/>			45°

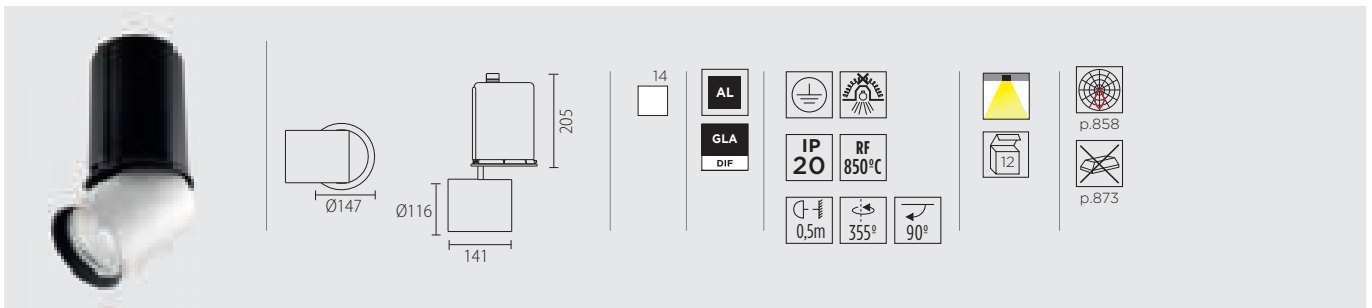

QR-111 / AR-111

G53



(max. H=100 mm)

71-1929-14-00	<input type="checkbox"/>	max.100W		
----------------------	--------------------------	----------	--	--

CDM-R111

GX8.5



71-1849-14-00	<input type="checkbox"/>	max.70W		
----------------------	--------------------------	---------	--	--

HIT-T

G12



71-1930-14-37	<input type="checkbox"/>	max.70W		10°
71-1931-14-37	<input type="checkbox"/>			24°
71-1932-14-37	<input type="checkbox"/>			45°

AR-111

GU10



(max. H=100 mm)

71-1928-14-00	<input type="checkbox"/>	-		
----------------------	--------------------------	---	--	--

Accesorios / Accessories / Accessoires / Zubehöre / Accessori / Acessórios / Аксессуары / Акcesoria

	ACT-9127-11-00	HIT-T	
	ACT-9131-11-00	QR-111	
	ACT-9127-08-00	HIT-T	
	ACT-9131-08-00	QR-111	
	ACT-9127-25-00	HIT-T	
	ACT-9131-25-00	QR-111	

	ACT-9127-24-00	HIT-T	
	ACT-9131-24-00	QR-111	
	ACT-9135-60-00	HIT-T	

HIT-T G12 70W 10°

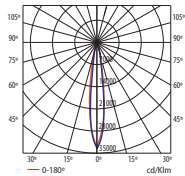

D(m)	MedLux
0.28	19864
0.55	4966
0.83	2207
1.11	1241

η=70%

HIT-T G12 70W 24°

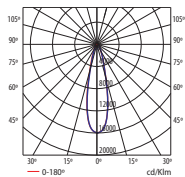

D(m)	MedLux
0.44	10194
0.88	2548
1.32	1133
1.76	637

η=64%

HIT-T G12 70W 45°

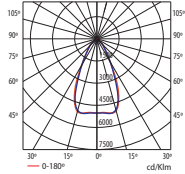

D(m)	MedLux
1.04	2978
2.08	744
3.12	331
4.16	186

η=65%



Accesorios necesarios / Accessories required / Accessoires nécessaires / Notwendig Zubehör / Accessori necessari /
 Acessórios necessários / Необходимые аксессуары / Akcesoria Konieczne

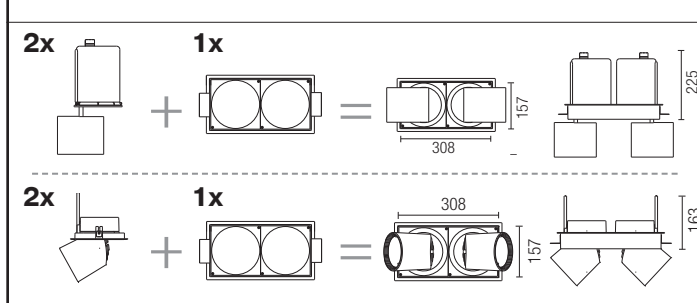
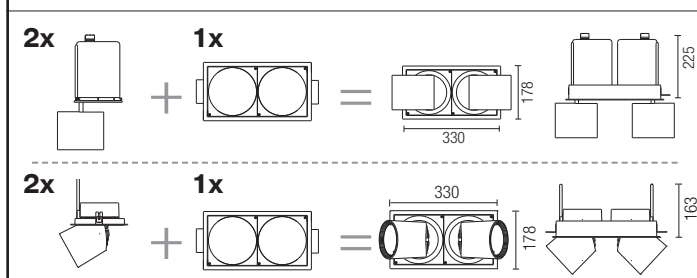
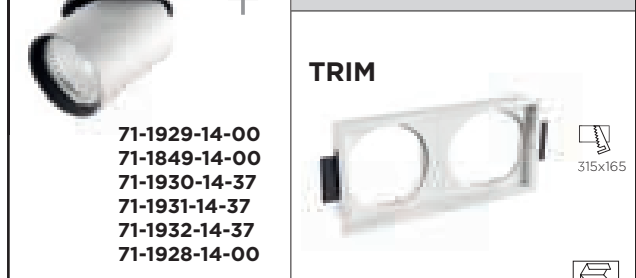
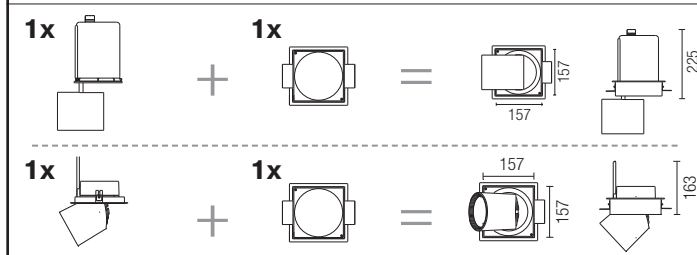
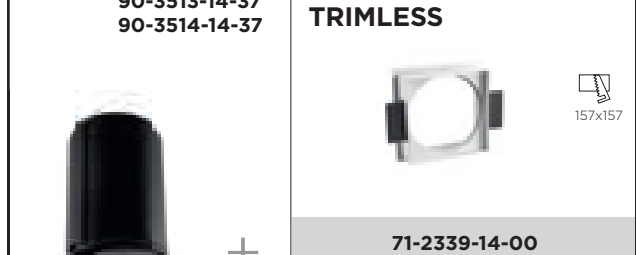
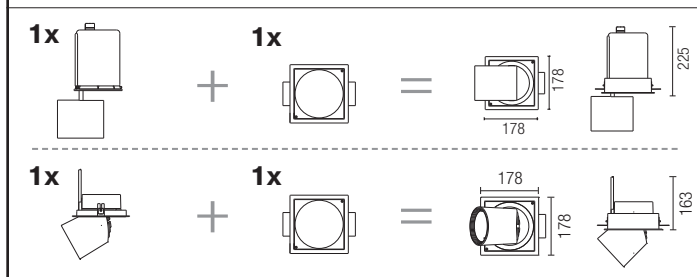
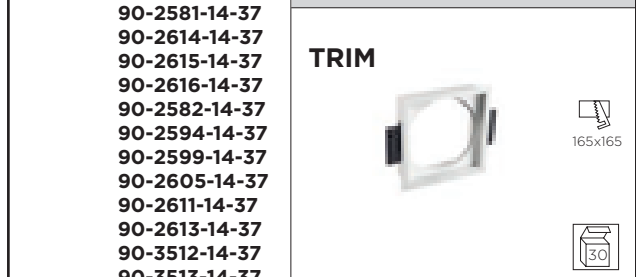
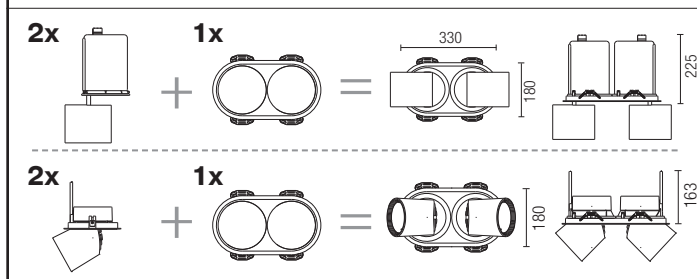
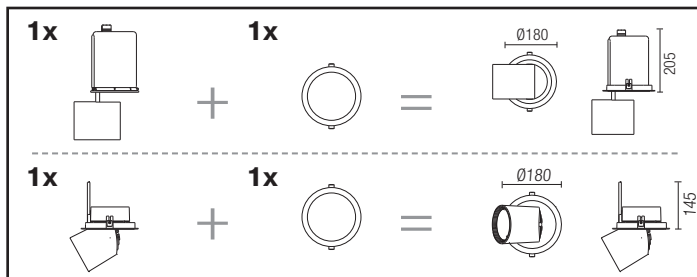
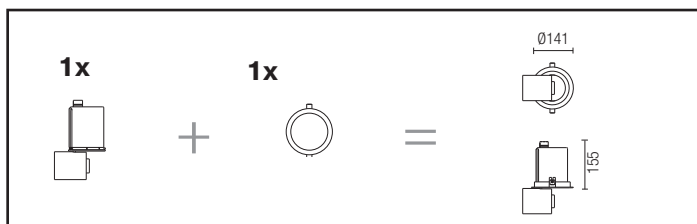
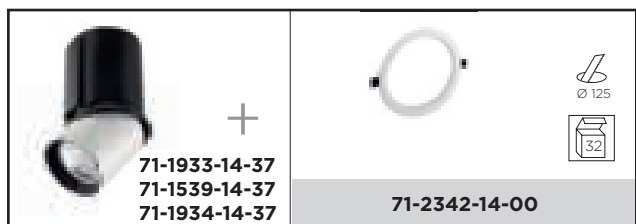

VIAX

0°

320°

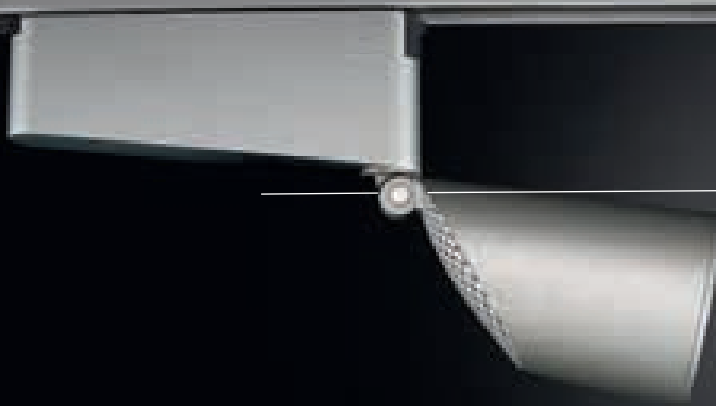
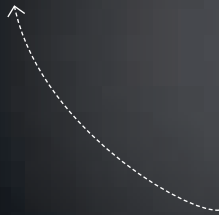
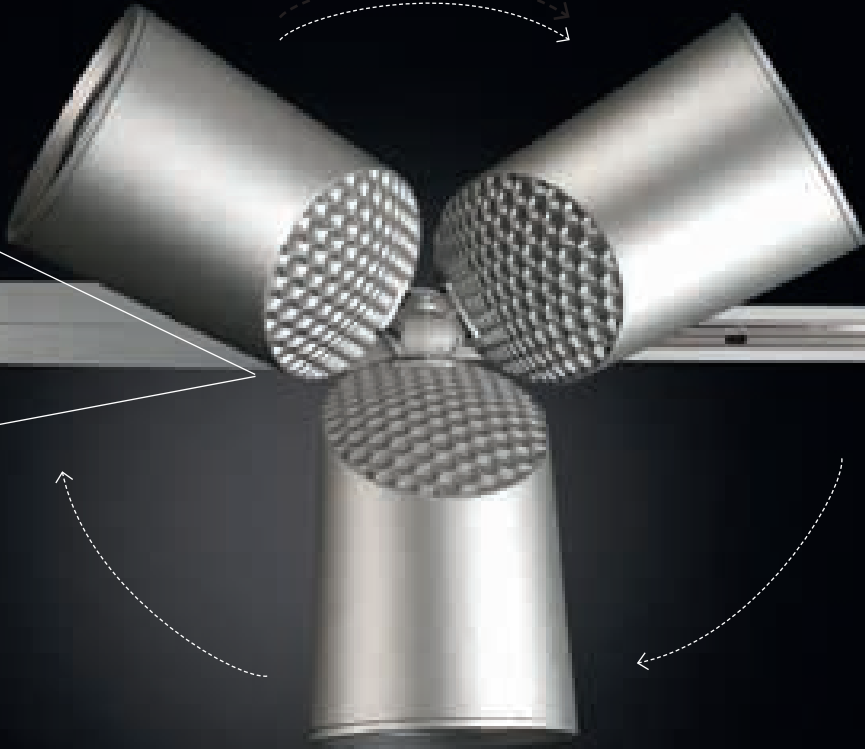
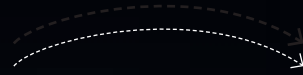

125°





QR-111
G53



CDM-R111
GX8.5



HIT-T
G12



AR-111 GU10
LEDS-C4

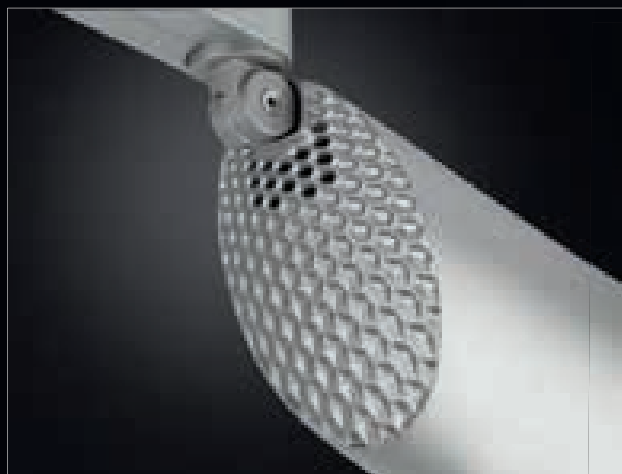

AÏTA STORE. MADRID, SPAIN.



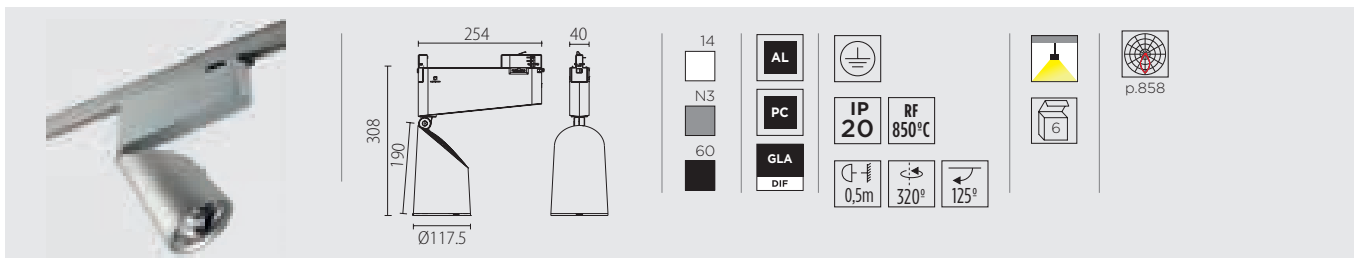

VIAX

**QR-111**

G53



(max. H=100 mm)

PR-0915-14-00 <input type="checkbox"/>	max.100W	* 220V 240V	09-14
PR-0915-60-00 <input checked="" type="checkbox"/>			
PR-0915-N3-00 <input checked="" type="checkbox"/>			

CDM-R111

GX8.5



PR-0916-14-00 <input type="checkbox"/>	35W	* 220V 240V	15-20
PR-0916-60-00 <input checked="" type="checkbox"/>			
PR-0916-N3-00 <input checked="" type="checkbox"/>	70W	* 220V 240V	15-20
PR-0917-14-00 <input type="checkbox"/>			
PR-0917-60-00 <input checked="" type="checkbox"/>			
PR-0917-N3-00 <input checked="" type="checkbox"/>			

HIT-T

G12

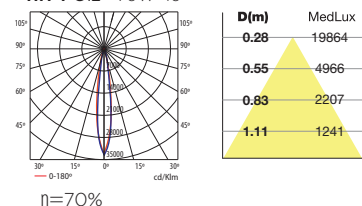
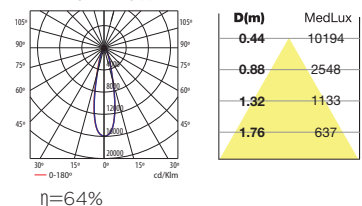
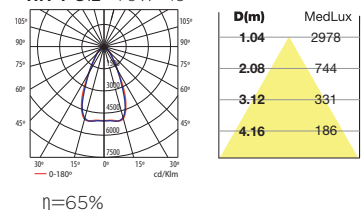

PR-0918-14-00 <input type="checkbox"/>	35W	* 220V 240V	10°
PR-0918-60-00 <input checked="" type="checkbox"/>			
PR-0918-N3-00 <input checked="" type="checkbox"/>			
PR-0919-14-00 <input type="checkbox"/>			
PR-0919-60-00 <input checked="" type="checkbox"/>			
PR-0919-N3-00 <input checked="" type="checkbox"/>			
PR-0920-14-00 <input type="checkbox"/>	70W	* 220V 240V	24°
PR-0920-60-00 <input checked="" type="checkbox"/>			
PR-0920-N3-00 <input checked="" type="checkbox"/>			
PR-0921-14-00 <input type="checkbox"/>			
PR-0921-60-00 <input checked="" type="checkbox"/>			
PR-0921-N3-00 <input checked="" type="checkbox"/>			
PR-0922-14-00 <input type="checkbox"/>	70W	* 220V 240V	45°
PR-0922-60-00 <input checked="" type="checkbox"/>			
PR-0922-N3-00 <input checked="" type="checkbox"/>			
PR-0923-14-00 <input type="checkbox"/>			
PR-0923-60-00 <input checked="" type="checkbox"/>			
PR-0923-N3-00 <input checked="" type="checkbox"/>			

HIT-T G12 70W 10°**HIT-T G12 70W 24°****HIT-T G12 70W 45°****AR-111**

GU10



(max. H=100 mm)

PR-0940-14-00 <input type="checkbox"/>	-	-	110V 240V	22-25
PR-0940-60-00 <input checked="" type="checkbox"/>				
PR-0940-N3-00 <input checked="" type="checkbox"/>				

VIAX, VIAX E, VIAX S

Accesorios / Accessories / Accessoires / Zubehöre / Accessori / Acessórios / Аксессуары / Akcesoria



ACT-9127-11-00 HIT-T

ACT-9131-11-00 QR-111



ACT-9127-24-00 HIT-T

ACT-9131-24-00 QR-111



ACT-9127-08-00 HIT-T

ACT-9131-08-00 QR-111



ACT-9135-60-00 HIT-T



ACT-9127-25-00 HIT-T

ACT-9131-25-00 QR-111

* Posibilidad de servir estas referencias sin equipo. Consulte a nuestro Equipo Comercial

VIAX S

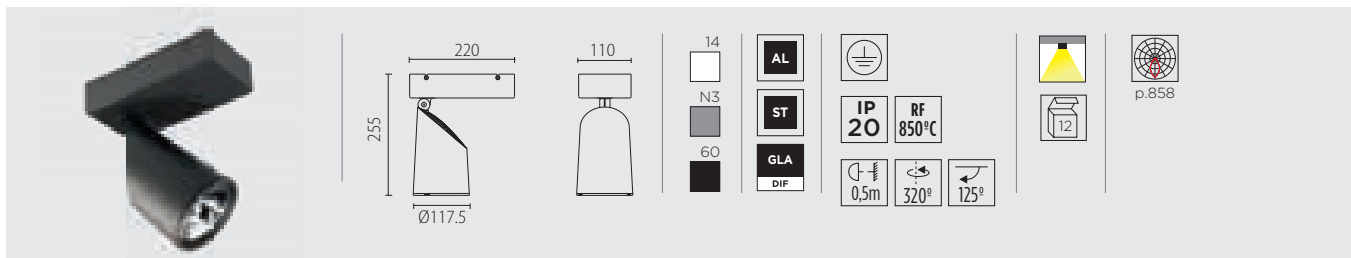

QR-111

G53



(max. H=100 mm)

PR-0975-14-00	<input type="checkbox"/>	max.100W	*	09-14
PR-0975-60-00	<input checked="" type="checkbox"/>			
PR-0975-N3-00	<input checked="" type="checkbox"/>			

CDM-R111

GX8.5



PR-0976-14-00	<input type="checkbox"/>	35W	*	15-20
PR-0976-60-00	<input checked="" type="checkbox"/>			
PR-0976-N3-00	<input checked="" type="checkbox"/>			
PR-0977-14-00	<input type="checkbox"/>	70W	*	15-20
PR-0977-60-00	<input checked="" type="checkbox"/>			
PR-0977-N3-00	<input checked="" type="checkbox"/>			

HIT-T

G12



PR-0978-14-00	<input type="checkbox"/>	35W	*	10°	
PR-0978-60-00	<input checked="" type="checkbox"/>			24°	
PR-0978-N3-00	<input checked="" type="checkbox"/>			45°	
PR-0979-14-00	<input type="checkbox"/>			70W	10°
PR-0979-60-00	<input checked="" type="checkbox"/>				24°
PR-0979-N3-00	<input checked="" type="checkbox"/>				45°
PR-0980-14-00	<input type="checkbox"/>	100W	10°		
PR-0980-60-00	<input checked="" type="checkbox"/>		24°		
PR-0980-N3-00	<input checked="" type="checkbox"/>		45°		
PR-0981-14-00	<input type="checkbox"/>		100W	10°	
PR-0981-60-00	<input checked="" type="checkbox"/>			24°	
PR-0981-N3-00	<input checked="" type="checkbox"/>			45°	
PR-0982-14-00	<input type="checkbox"/>	100W		10°	
PR-0982-60-00	<input checked="" type="checkbox"/>			24°	
PR-0982-N3-00	<input checked="" type="checkbox"/>			45°	
PR-0983-14-00	<input type="checkbox"/>		100W	10°	
PR-0983-60-00	<input checked="" type="checkbox"/>			24°	
PR-0983-N3-00	<input checked="" type="checkbox"/>			45°	
PR-0984-14-00	<input type="checkbox"/>	100W		10°	
PR-0984-60-00	<input checked="" type="checkbox"/>			24°	
PR-0984-N3-00	<input checked="" type="checkbox"/>			45°	
PR-0985-14-00	<input type="checkbox"/>		100W	10°	
PR-0985-60-00	<input checked="" type="checkbox"/>			24°	
PR-0985-N3-00	<input checked="" type="checkbox"/>			45°	
PR-0986-14-00	<input type="checkbox"/>	100W		10°	
PR-0986-60-00	<input checked="" type="checkbox"/>			24°	
PR-0986-N3-00	<input checked="" type="checkbox"/>			45°	

HIT-T G12 70W 10°

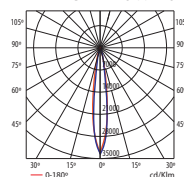

$\eta=70\%$

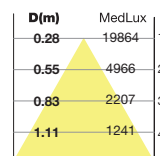

HIT-T G12 70W 24°

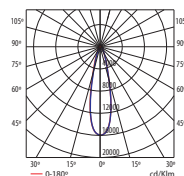

$\eta=64\%$

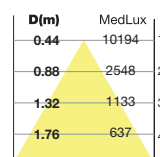

HIT-T G12 70W 45°

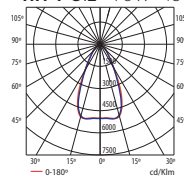

$\eta=65\%$

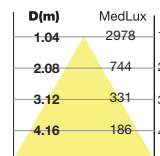

AR-111

GU10



(max. H=100 mm)

PR-0987-14-00	<input type="checkbox"/>	-	-		22-25
PR-0987-60-00	<input checked="" type="checkbox"/>				
PR-0987-N3-00	<input checked="" type="checkbox"/>				

* Posibilidad de servir estas referencias sin equipo. Consulte a nuestro Equipo Comercial



VIAX E

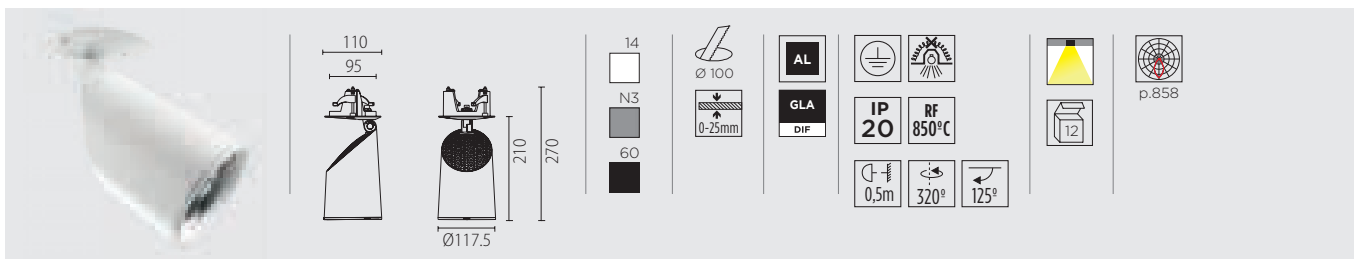

QR-111

G53



(max. H=100 mm)

PR-0924-14-00 <input type="checkbox"/>	max.100W	* 220V 240V	09-14
PR-0924-60-00 <input checked="" type="checkbox"/>			
PR-0924-N3-00 <input checked="" type="checkbox"/>			

CDM-R111

GX8.5



PR-0925-14-00 <input type="checkbox"/>	35W	* 220V 240V	15-20
PR-0925-60-00 <input checked="" type="checkbox"/>			
PR-0925-N3-00 <input checked="" type="checkbox"/>	70W	* 220V 240V	15-20
PR-0926-14-00 <input type="checkbox"/>			
PR-0926-60-00 <input checked="" type="checkbox"/>			
PR-0926-N3-00 <input checked="" type="checkbox"/>			

HIT-T

G12



PR-0927-14-00 <input type="checkbox"/>	35W	* 220V 240V	10°
PR-0927-60-00 <input checked="" type="checkbox"/>			
PR-0927-N3-00 <input checked="" type="checkbox"/>			
PR-0928-14-00 <input type="checkbox"/>			
PR-0928-60-00 <input checked="" type="checkbox"/>	70W	* 220V 240V	24°
PR-0928-N3-00 <input checked="" type="checkbox"/>			
PR-0929-14-00 <input type="checkbox"/>			
PR-0929-60-00 <input checked="" type="checkbox"/>			
PR-0929-N3-00 <input checked="" type="checkbox"/>			
PR-0930-14-00 <input type="checkbox"/>			
PR-0930-60-00 <input checked="" type="checkbox"/>			
PR-0930-N3-00 <input checked="" type="checkbox"/>			
PR-0931-14-00 <input type="checkbox"/>	70W	* 220V 240V	10°
PR-0931-60-00 <input checked="" type="checkbox"/>			
PR-0931-N3-00 <input checked="" type="checkbox"/>			
PR-0932-14-00 <input type="checkbox"/>			
PR-0932-60-00 <input checked="" type="checkbox"/>	70W	* 220V 240V	24°
PR-0932-N3-00 <input checked="" type="checkbox"/>			
PR-0932-14-00 <input type="checkbox"/>	70W	* 220V 240V	45°
PR-0932-60-00 <input checked="" type="checkbox"/>			
PR-0932-N3-00 <input checked="" type="checkbox"/>	70W	* 220V 240V	45°
PR-0932-14-00 <input type="checkbox"/>			

AR-111

GU10



(max. H=100 mm)

PR-0941-14-00 <input type="checkbox"/>	-	-	* 110V 240V	22-25
PR-0941-60-00 <input checked="" type="checkbox"/>				
PR-0941-N3-00 <input checked="" type="checkbox"/>				

VIAX, VIAX E, VIAX S

Accesorios / Accessories / Accessoires / Zubehöre / Accessori / Acessórios / Аксессуары / Aksesoria



ACT-9127-11-00 HIT-T

ACT-9131-11-00 QR-111



ACT-9127-24-00 HIT-T

ACT-9131-24-00 QR-111



ACT-9127-08-00 HIT-T

ACT-9131-08-00 QR-111



ACT-9135-60-00 HIT-T



ACT-9127-25-00 HIT-T

ACT-9131-25-00 QR-111

HIT-T G12 70W 10°

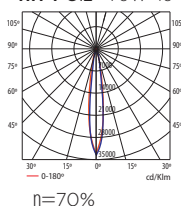

HIT-T G12 70W 24°

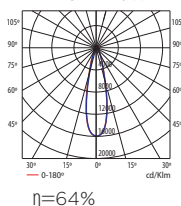

HIT-T G12 70W 45°

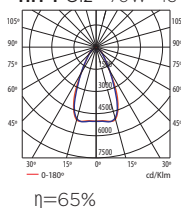

* Posibilidad de servir estas referencias sin equipo. Consulte a nuestro Equipo Comercial

ACTION

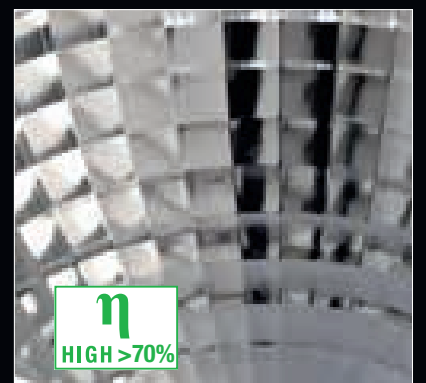



QR-111
G53

CDM-R111
GX8.5

HIT-T
G12

AR-111 GU10
LEDS-C4

LED
Estándar Zhaga
Zhaga Standard







ACTION

NEW

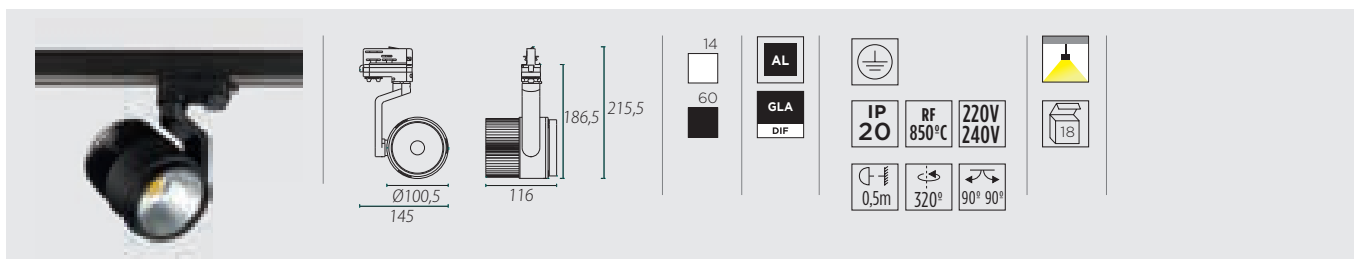

LED

Estándar Zhaga / Zhaga Standard	35-2512-14-37	<input type="checkbox"/>	2000 lm ^(N)	3000K	CRI>80	24°	26W	
	35-2512-60-37	<input checked="" type="checkbox"/>				38°		
	35-2515-14-37	<input type="checkbox"/>				24°		
	35-2515-60-37	<input checked="" type="checkbox"/>				38°		
	35-2513-14-37	<input type="checkbox"/>				24°		
	35-2513-60-37	<input checked="" type="checkbox"/>				38°		
	35-2517-14-37	<input type="checkbox"/>				24°		
	35-2517-60-37	<input checked="" type="checkbox"/>				38°		

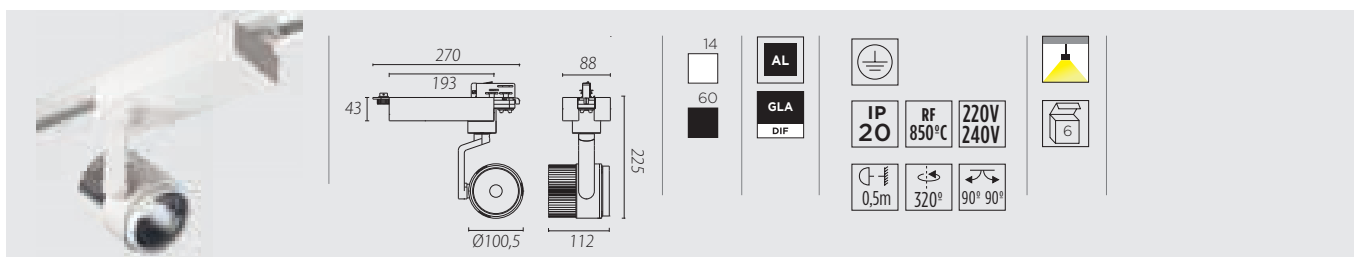

LED

Estándar Zhaga / Zhaga Standard	35-2210-14-37	<input type="checkbox"/>	2000 lm ^(N)	3000K	CRI>90	24°	23W	
	35-2210-60-37	<input checked="" type="checkbox"/>				38°		
	35-2215-14-37	<input type="checkbox"/>				24°		
	35-2215-60-37	<input checked="" type="checkbox"/>				38°		
	35-2200-14-37	<input type="checkbox"/>				24°		
	35-2200-60-37	<input checked="" type="checkbox"/>				38°		
	35-2202-14-37	<input type="checkbox"/>				24°		
	35-2202-60-37	<input checked="" type="checkbox"/>				38°		
	35-2204-14-37	<input type="checkbox"/>	3000 lm ^(N)	4000K	CRI>80	24°	26W	
	35-2204-60-37	<input checked="" type="checkbox"/>				38°		
	35-2205-14-37	<input type="checkbox"/>	3000K	CRI>90	24°	33W		
	35-2205-60-37	<input checked="" type="checkbox"/>					38°	
	35-3510-14-37	<input type="checkbox"/>	3000K	CRI>90	24°	33W		
	35-3510-60-37	<input checked="" type="checkbox"/>						
	35-3511-14-37	<input type="checkbox"/>						
	35-3511-60-37	<input checked="" type="checkbox"/>	38°					

LED 3000lm 24° 3000K

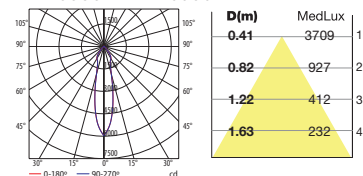

Accesorios / Accessories / Accessoires / Zubehöre / Accessori / Acessórios / Аксессуары / Aksesoria



71-2675-60-00

LED



* Posibilidad de servir estas referencias sin equipo. Consulte a nuestro Equipo Comercial

ACTION

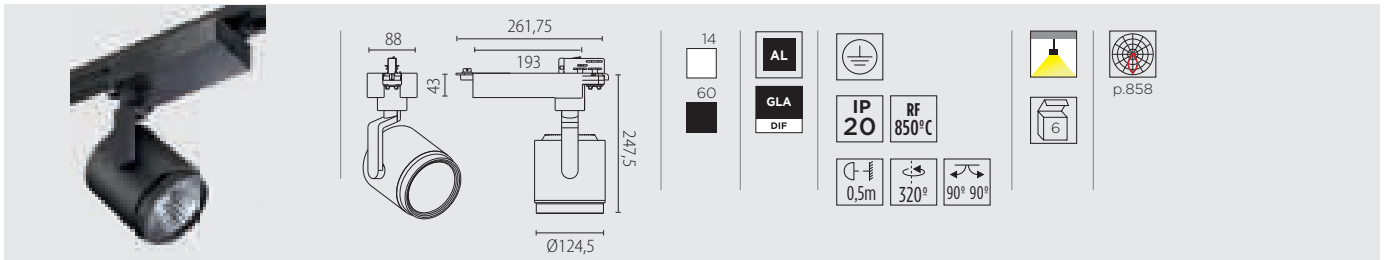

QR-111

G53 	PR-0946-14-00 <input type="checkbox"/>	max.100W	*	09-14
(max. H=100 mm)	PR-0946-60-00 <input checked="" type="checkbox"/>			

CDM-R111

GX8.5 	PR-0947-14-00 <input type="checkbox"/>	35W	*	15-20
	PR-0947-60-00 <input checked="" type="checkbox"/>			
	PR-0948-14-00 <input type="checkbox"/>	70W		
	PR-0948-60-00 <input checked="" type="checkbox"/>			

HIT-T

G12 	PR-0949-14-37 <input type="checkbox"/>	35W	*	12°
	PR-0949-60-37 <input checked="" type="checkbox"/>			
	PR-0950-14-37 <input type="checkbox"/>			
	PR-0950-60-37 <input checked="" type="checkbox"/>			
	PR-0951-14-37 <input type="checkbox"/>			
	PR-0951-60-37 <input checked="" type="checkbox"/>			
	PR-0952-14-37 <input type="checkbox"/>	70W		12°
	PR-0952-60-37 <input checked="" type="checkbox"/>			
	PR-0953-14-37 <input type="checkbox"/>			
	PR-0953-60-37 <input checked="" type="checkbox"/>			
	PR-0954-14-37 <input type="checkbox"/>			
	PR-0954-60-37 <input checked="" type="checkbox"/>			

HIT-T G12 70W 12°

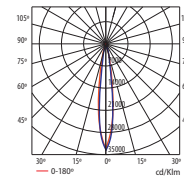

$\eta=70\%$

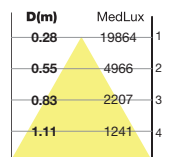

HIT-T G12 70W 24°

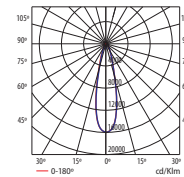

$\eta=64\%$

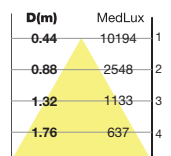

AR-111

GU10 	PR-0955-14-00 <input type="checkbox"/>	-	-		22-25
(max. H=100 mm)	PR-0955-60-00 <input checked="" type="checkbox"/>				

HIT-T G12 70W 38°

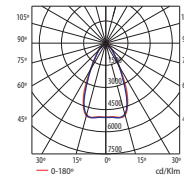

$\eta=65\%$

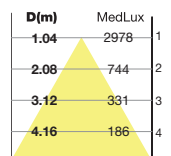

Accesorios / Accessories / Accessoires / Zubehöre / Accessori / Acessórios / Аксессуары / Акcesoria

	ACT-0451-00-00 HIT-T		ACT-9180-60-00 HIT-T
	ACT-9131-11-00 QR-111		
	ACT-0452-00-00 HIT-T		ACT-9181-14-00 <input type="checkbox"/> HIT-T
	ACT-9131-08-00 QR-111		ACT-9181-60-00 <input checked="" type="checkbox"/> QR-111
	ACT-0454-00-00 HIT-T		
	ACT-9131-25-00 QR-111		
	ACT-0453-00-00 HIT-T		
	ACT-9131-24-00 QR-111		

* Posibilidad de servir estas referencias sin equipo. Consulte a nuestro Equipo Comercial



ACTION

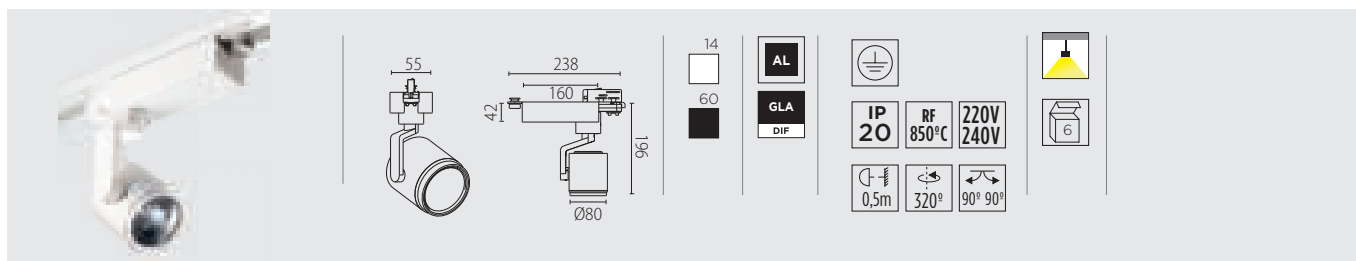

CDM-Tm

PGJ5



PR-0956-14-37	<input type="checkbox"/>	20W		*	12°
PR-0956-60-37	<input checked="" type="checkbox"/>				24°
PR-0957-14-37	<input type="checkbox"/>				38°
PR-0957-60-37	<input checked="" type="checkbox"/>				12°
PR-0958-14-37	<input type="checkbox"/>				24°
PR-0958-60-37	<input checked="" type="checkbox"/>				38°
PR-0959-14-37	<input type="checkbox"/>	35W		*	12°
PR-0959-60-37	<input checked="" type="checkbox"/>				24°
PR-0960-14-37	<input type="checkbox"/>				38°
PR-0960-60-37	<input checked="" type="checkbox"/>				
PR-0961-14-37	<input type="checkbox"/>				
PR-0961-60-37	<input checked="" type="checkbox"/>				

CDM-TM PGJ5 35W 12°

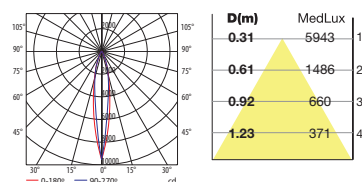

$\eta=58\%$

CDM-TM PGJ5 35W 24°

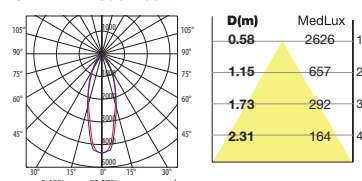

$\eta=68\%$

CDM-TM PGJ5 35W 38°

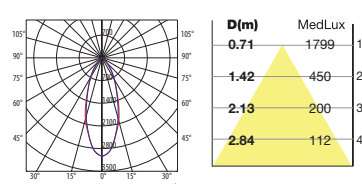

$\eta=62\%$

* Posibilidad de servir estas referencias sin equipo. Consulte a nuestro Equipo Comercial





KEY

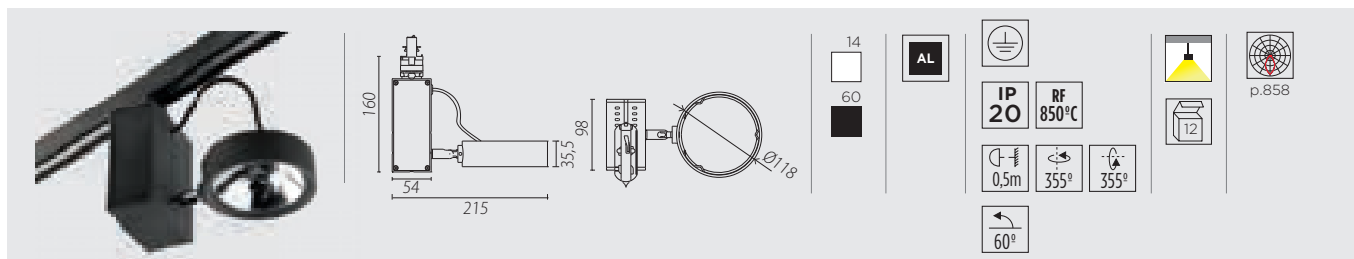

QR-111

G53



35-1559-14-00	<input type="checkbox"/>	max.100W		*	220V 240V		09-14
35-1559-60-00	<input checked="" type="checkbox"/>						

CDM-R111

GX8.5



35-1557-14-00	<input type="checkbox"/>	35W		*	220V 240V		15-20
35-1557-60-00	<input checked="" type="checkbox"/>						
35-1558-14-00	<input type="checkbox"/>	70W		*	220V 240V		15-20
35-1558-60-00	<input checked="" type="checkbox"/>						

AR-111

GU10



35-1565-14-00	<input type="checkbox"/>	-	-	110V 240V		22-25
35-1565-60-00	<input checked="" type="checkbox"/>					



NEW

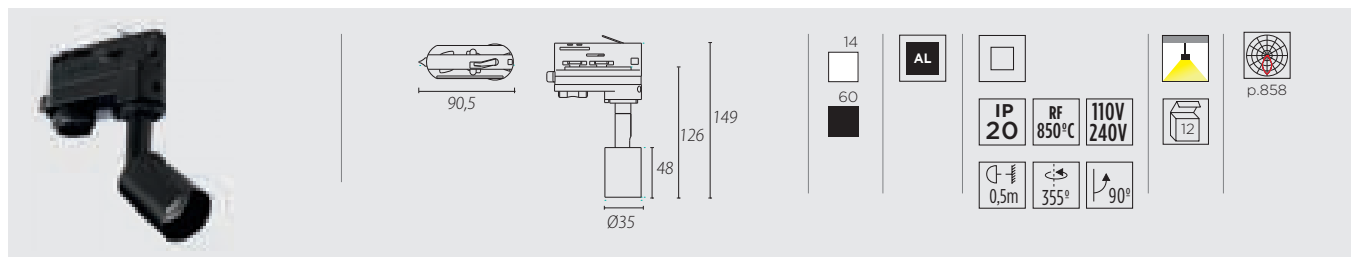

AR-111 / QPAR-16

GU10



35-2898-14-00	<input type="checkbox"/>	max.75W	-	-		1-8 21-25
35-2898-60-00	<input checked="" type="checkbox"/>					

Accesorios / Accessories / Accessoires / Zubehöre / Accessori / Acessórios / Аксессуары / Akcesoria

**ACT-9131-11-00** QR-111 **ACT-9131-25-00** QR-111 **ACT-9131-08-00** QR-111 **ACT-9131-24-00** QR-111 **ACT-9105-14-00**

Base para montaje en superficie /
Base for surface mounting /
Base pour montage en surface /
Unterbau zur Aufbaumontage /
Base per il montaggio in superficie /
Base para instalação à superfície
Основание для поверхностного
монтажа /
Podstawa do zamontowania na
powierzchni

**ACT-9106-14-00**

Caja para empotrar
Recessed box
Boîtier à encastrer
Gehäuse zum Einbau
Scatola per incasso
Caixa para encastrar
Бокс для встроенного монтажа
Skrzynka do wbudowania

ACT-9105-60-00 **ACT-9106-60-00**

* Posibilidad de servir estas referencias sin equipo. Consulte a nuestro Equipo Comercial

MACH1

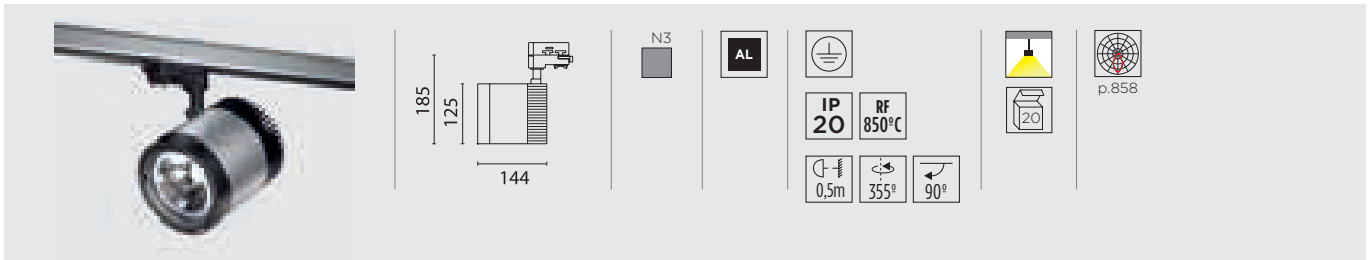

QR-111

G53



(max. H=100 mm)

PR-0020-N3-00



max.60W



* 220V
240V



09-14

AR-111

GU10



(max. H=100 mm)

PR-0944-N3-00



-

-

110V
240V



22-25

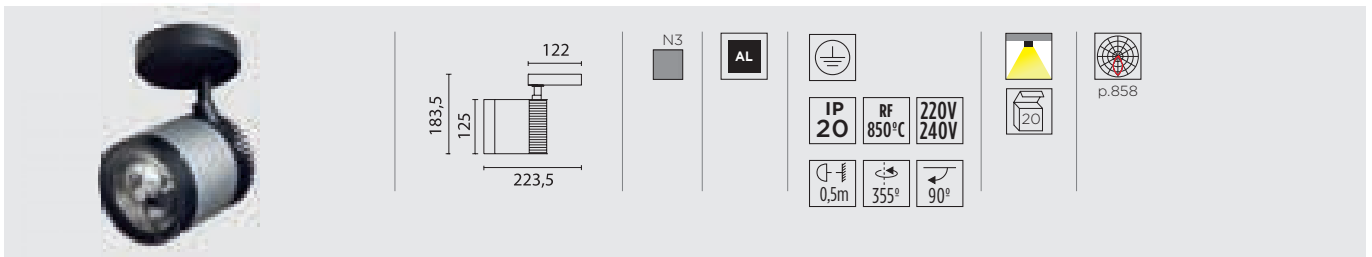

QR-111

G53



(max. H=100 mm)

PR-0019-N3-00



max.60W



* 220V
240V



09-14

AR-111

GU10



(max. H=100 mm)

PR-0945-N3-00



-

-

110V
240V



22-25

Accesorios / Accessories / Accessoires / Zubehöre / Accessori / Acessórios / Аксессуары / Aksesoria



ACT-0451-00-00 HIT-T



ACT-9131-11-00 QR-111



ACT-0453-00-00 HIT-T



ACT-9131-24-00 QR-111



ACT-0452-00-00 HIT-T



ACT-9131-08-00 QR-111



ACT-0455-60-00



ACT-0454-00-00 HIT-T



ACT-9131-25-00 QR-111



* Posibilidad de servir estas referencias sin equipo. Consulte a nuestro Equipo Comercial



MACH1

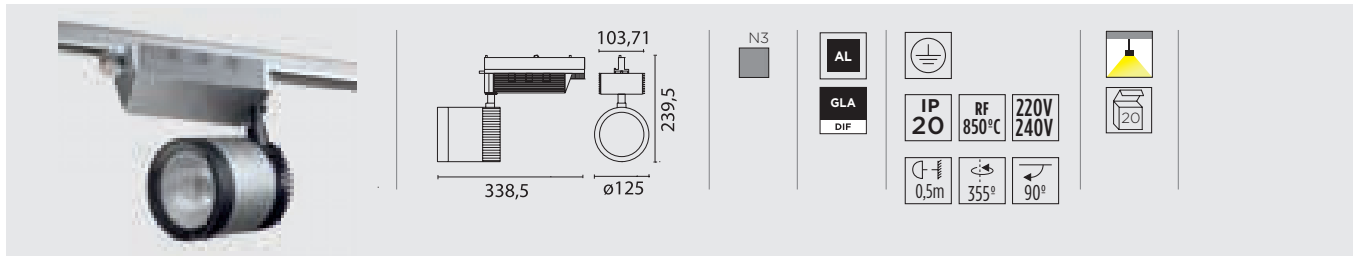

HIT-T

G12



PR-0382-N3-00		70W		10°
PR-0936-N3-00				24°
PR-0383-N3-00				45°
PR-0384-N3-00		150W		10°
PR-0937-N3-00				24°
PR-0385-N3-00				45°

HIT-T G12 70W 10°

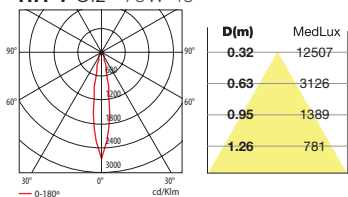

$\eta=56\%$

HIT-T G12 70W 24°

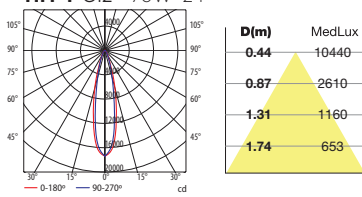

$\eta=64\%$

HIT-T G12 70W 45°

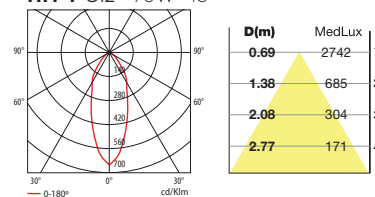

$\eta=50\%$

HIT-T G12 150W 10°

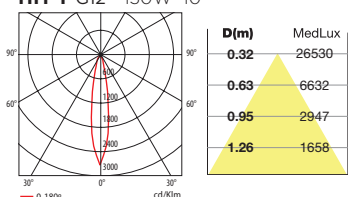

$\eta=56\%$

HIT-T G12 150W 24°

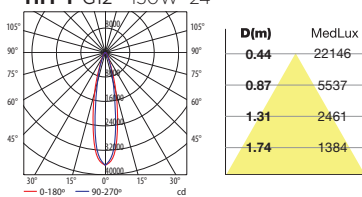

$\eta=64\%$

HIT-T G12 150W 45°

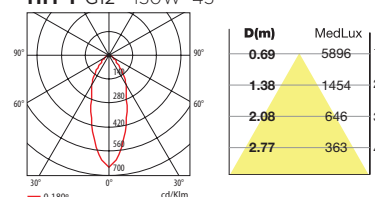

$\eta=50\%$

Accesorios / Accessories / Accessoires / Zubehöre / Accessori / Acessórios / Аксессуары / Akcesoria



ACT-0451-00-00 HIT-T



ACT-9131-11-00 QR-111



ACT-0453-00-00 HIT-T



ACT-9131-24-00 QR-111



ACT-0452-00-00 HIT-T



ACT-9131-08-00 QR-111



ACT-0455-60-00



ACT-0454-00-00 HIT-T



ACT-9131-25-00 QR-111



* Posibilidad de servir estas referencias sin equipo. Consulte a nuestro Equipo Comercial

CARRILES / TRACKS

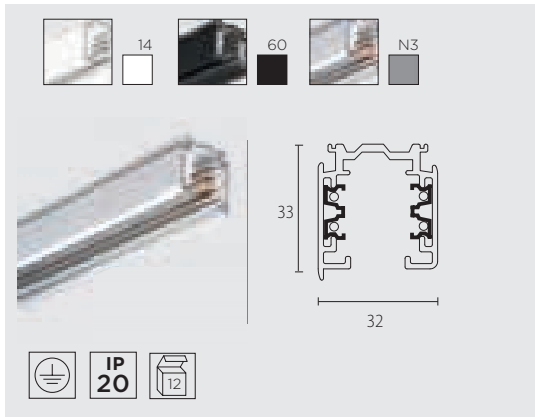

CR-0323-14-00	<input type="checkbox"/>	1000 mm	Carril trifásico Three-circuit track Rail triphasé
CR-0323-60-00	<input checked="" type="checkbox"/>		
CR-0323-N3-00	<input checked="" type="checkbox"/>		
CR-0324-14-00	<input type="checkbox"/>	2000 mm	3-Phasen-Schiene Binario trifásico Calha trifásico Трёхфазный шинопровод
CR-0324-60-00	<input checked="" type="checkbox"/>		
CR-0324-N3-00	<input checked="" type="checkbox"/>		
71-3285-14-00	<input type="checkbox"/>	3000 mm	Trójfazowa szyna
71-3285-60-00	<input checked="" type="checkbox"/>		
71-3285-N3-00	<input checked="" type="checkbox"/>		

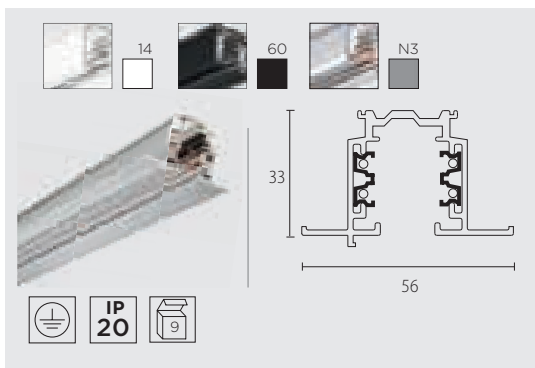

CR-0337-14-00	<input type="checkbox"/>	1000 mm	Carril trifásico para montaje empotrado Three-circuit track for recessed mounting Rail électrifié triphasé à montage encastré 3-Phasen-Schiene Einbau
CR-0337-60-00	<input checked="" type="checkbox"/>		
CR-0337-N3-00	<input checked="" type="checkbox"/>		
CR-0338-14-00	<input type="checkbox"/>	2000 mm	Binario trifásico per montaggio ad incasso Calha trifásica para montagem encastrada Трёхфазный шинопровод для встроенного монтажа Trójfazowa szyna do wbudowania
CR-0338-60-00	<input checked="" type="checkbox"/>		
CR-0338-N3-00	<input checked="" type="checkbox"/>		

ACT-9165-48-00

1m= 1 kit / 2m= 2 kits



Kit para empotrar (2 unidades/ref)
Recessed kit (2 units/ref)
Kit d'encastrement (2 unités/réf)
Einbaukit (2 Stk/Ref)
Kit per incasso (2 unità/rif)
Kit para encastrar (2 unidades/ref)
Набор для встроенного монтажа (2 шт/артикул)
Zestaw do wbudowania (2 sztuki/ref.)

Esquema de conexión / Connection scheme / Schéma de branchement / Schaltbild / Schema di connessione / Esquema de ligação / Схема подсоединения / Schemat montażowy

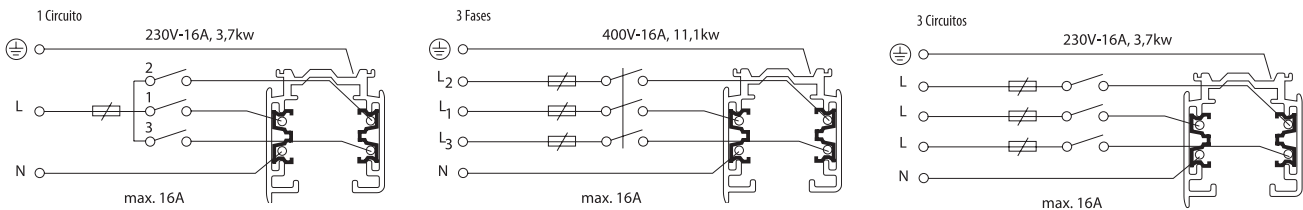

Distancia recomendada entre fijaciones / Recommended distance for fixations / Distance recommandée entre les fixations / Empfohlener Abstand zwischen Befestigungen / Distanza consigliata fra punti di fissaggio / Distância recomendada entre fixações / Рекомендованное расстояние между деталями крепежа / Zalecana odległość pomiędzy zamocowaniami

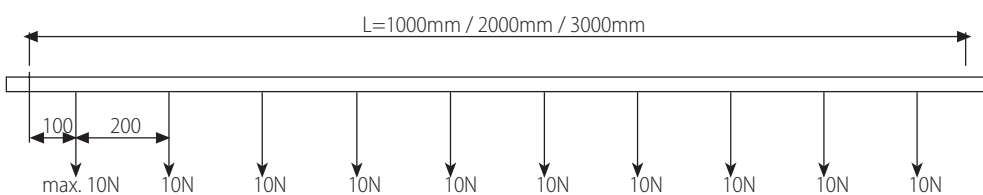



Elementos de fijación y accesorios / Installation accessories/ Éléments de fixation et accessoires / Befestigungselemente und Zubehör / Elementi di fissaggio e accessori / Elementos de fixação e acessórios / Elementy mocujące i akcesoria / Крепелж и аксессуары



CR-0333-14-00
CR-0333-N3-00

Para piezas de fijación directa a falsos techos.
 For direct mounting on false ceilings.
 Destiné à la fixation directe sur faux plafonds.
 Für Teile zur direkten Befestigung an Zwischendecken.
 Per l'installazione diretta su controsoffitti.
 Para fixação direta a tectos falsos/
 Для светильников, монтируемых непосредственно в подвесные потолки /
 Dla elementów bezpośrednio mocowanych do podwieszanych sufitów/

4 unidades/ref / 4 units/ref / 4 unités/ref /
 4 Stk/Ref / 4 unidades/Ref / 4 unità/rif / 4
 штуки/артикул / 4 sztuki/ref.

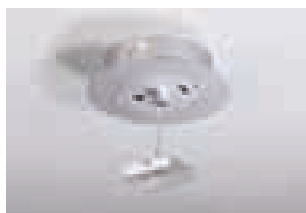

CR-0334-14-00
CR-0334-N3-00

Suspension con toma de corriente /
 Suspension with mains supply /
 Suspension avec prise d'alimentation /
 Aufhängung mit Stromanschluss /
 Sospensione con presa di corrente /
 Suspensão com tomada de corrente /
 Подвесной монтаж с включением в сеть /
 Zawieszenie z elementem zasilającym prądu /



CR-0335-00-00

Herramienta de doblado /
 Ending tool needed after cutting the track./
 Outil de pliage nécessaire après la coupe du rail./
 Biegwerkzeug /
 Attrezzo necessario dopo aver tagliato il binario./
 Ferramenta de dobragem./
 Инструмент для сгибания /
 Narzędzie do zaginania/



CR-0336-14-00
CR-0336-N3-00

Sirga de acero / Steel cable / Câble de suspension en acier /
 Stahlkabel / Cavo in acciaio / Cabo de suspensão em aço /
 Подвесной монтаж (1.300mm) / Stalowa linka

2 unidades/ref / 2 units/ref / 2 unités/ref /
 2 Stk/Ref / 2 unità/rif / 2 unidades/Ref / 2
 штуки/артикул / 2 sztuki/ref.

Accesorios de conexión / Connection accessories / Accessoires de connexion / Anschlusszubehöre / Accessori di connessione / Acessórios de ligação / Аксессуары для подключения / Akcesoria łączące



CR-0325-14-00

Acometida izquierda/
 Mains connector (left)/
 Connecteur d'alimentation gauche/
 Anschluss links/

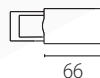

CR-0325-60-00

Allacciamento sinistro /
 Conector de alimentação esquerdo/
 Токопровод левый /
 Lewe zasilanie/



CR-0328-14-00

Conector continuidad/
 Straight connector/
 Connecteur de continuité/
 Stecker Durchgängigkeit/

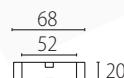

CR-0328-60-00

Connettore di continuità/
 Conector de continuidade/
 Токопровод центральный /
 Złączka liniowa/



CR-0326-14-00

Acometida derecha/
 Mains connector (right)/
 Connecteur d'alimentation droit/
 Anschluss rechts/

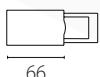

CR-0326-60-00

Allacciamento destro/
 Conector de alimentação direito/
 Токопровод правый /
 Prawe zasilanie/



CR-0329-14-00

Conector ajustable/
 Adjustable connector/
 Connecteur réglable/
 Verstellbarer Stecker/

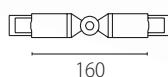

CR-0329-60-00

Connettore regolabile/
 Conector regulável /
 Токопровод поворотный регулируемый /
 Złączka regulowana/



CR-0327-14-00

tapa final/
 end cap/
 cache final/
 endkappe/



CR-0327-60-00

cappuccio finale/
 topo final /
 торцевая заглушка /
 Zaślepka /



CR-0331-14-00

Conector "T" izquierdo/
 "T" connector left/
 Connecteur en « T » gauche/
 T-Stecker links /

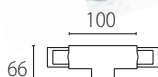

CR-0331-60-00

Connettore a "T" sinistro /
 Conector "T" esquerdo /
 Токопровод Т-образный левый /
 Lewa złączka w kształcie T /



CR-0332-14-00

Conector "T" derecho/
 "T" connector right/
 Connecteur en « T » droit/
 T-Stecker rechts/

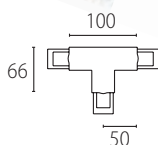

CR-0332-60-00

Connettore a "T" destro/
 Токопровод Т-образный правый /
 Prawa złączka w kształcie T/



71-2232-14-14

Conector de carril /
 Track connector /
 Connecteur de rail /
 Schienenstecker /

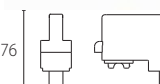

71-2232-60-60

Collegamento binari /
 Conector de calha /
 Соединитель шины/
 Łącznik szyny

TECHNICAL

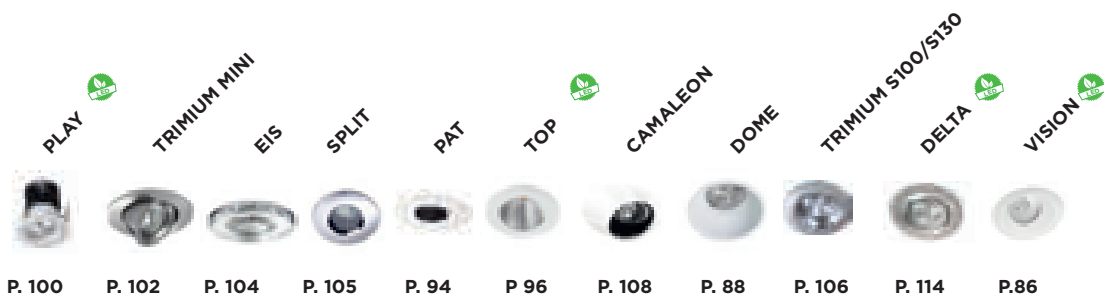

	P. 100	P. 102	P. 104	P. 105	P. 94	P. 96	P. 108	P. 88	P. 106	P. 114	P. 86
Ø 61-70mm		■	■								
Ø 71-80mm			■	■	■	■	■				
Ø 81-90mm		■						■	■	■	
Ø 91-100mm		■									■
Ø 111-120mm								■	■		
Ø 121-130mm										■	
Ø 131-140mm										■	
Ø 141-150mm											
Ø 151-160mm											
Ø 161-170mm											
Ø 171-180mm											
Ø 191-200mm							■	■			
Ø 201-210mm											
Ø 211-220mm											
Ø 221-230mm											
Ø 231-240mm											
QR-111/G53 100W							■	■			
CDM-R111/GX8.5 70W							■	■			
QR-CBC51/GU5.3 50W		■	■	■	■		■	■	■		
HIT-T/G12 70/150W											
HIT-TC/G8.5 70W									■		
GX24q 26W							■		■		
G24q 18/26W											
G24d 18/26W											
E-27											
AR-111/GU10							■	■			
MR16/GU5.3		■	■	■	■		■	■	■		
QPAR16/GU10		■			■		■	■	■		
LED		Max.7/13W				5,5W				Max 19,8W Max. 8,8W	
LED Zhaga		2000lm/3000lm									
Fijo/ Fixed	■	■	■	■		■	■	■	■		■
Orientable / Adjustable	■	■			■		■	■		■	■
IP20											
IP23		■			■		■	■		■	
IP40											
IP43											
IP44	■					■					■
IP54			■						■		
IP65				■							
		■ (1)					■ (1)		■ (1)		

TECHNICAL

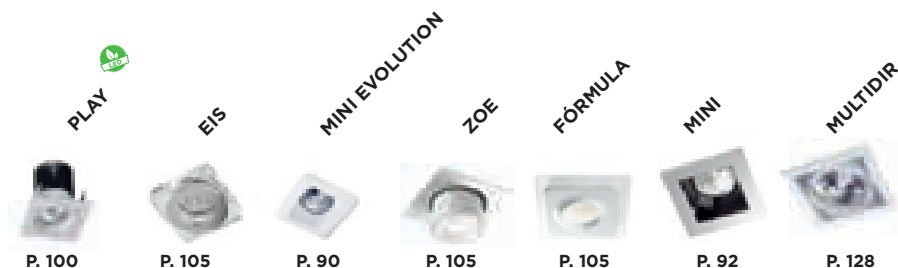

Ø 61-70mm		■					
Ø 71-80mm		■		■	■	■	
Ø 81-90mm							■
81-90mm x 61-70mm							■
101-110mm x 101-110mm							■
121-130mm x 121-130mm							■
151-160mm x 151-160mm							■
161-170mm x 161-170mm							■
171-180mm x 61-70mm							■
171-180mm x 231-240mm							■
181-190mm x 181-190mm							■
191-200mm x 191-200mm							■
201-210mm x 101-110mm							■
201-210mm x 201-210mm							■
211-220mm x 211-220mm							■
231-240mm x 61-70mm							■
231-240mm x 231-240mm							■
251-260mm x 151-160mm							■
291-300mm x 151-160mm							■
291-300mm x 291-300mm							■
301-310mm x 101-110mm							■
301-310mm x 151-160mm							■
311-320mm x 161-170mm							■
311-320mm x 311-320mm							■
441-450mm x 151-160mm							■
451-460mm x 161-170mm							■
591-600mm x 591-600mm							■
QR-111/G53	100W						■
CDM-R111/GX8.5	70W						■
QR-CBC51/GU5.3	50W	■	■	■	■	■	■
HIT-TC G8.5							■
HIT-DE RX7s							■
GX24q	26W						■
G24q	18W						■
AR-111/GU10							■
MR16/GU5.3		■	■	■	■	■	■
QPAR16/GU10		■	■		■	■	■
LED							
LED Zhaga	2000lm/3000lm						
Fijo/ Fixed		■	■	■	■	■	
Orientable/ Adjustable		■					■
IP20							
IP23				■	■		■
IP40							■
IP44		■					
IP54			■				
IP65						■	



■ (1)



GES

NEW

<p>90-2902-14-00</p>	<p>90-2903-14-00</p>	14 		
-----------------------------	-----------------------------	--------	--	--

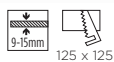

QR-CBC51 / MR16

GU5.3

90-2902-14-00

max. 35W



12V



01-08



QR-CBC51 / MR16

GU5.3

90-2903-14-00



max. 50W



12V

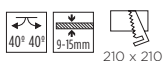

01-08



Accesorios / Accessoires / Zubehöre / Accessori / Acessórios / Аксессуары / Akcesoria

71-1881-00-00

Kit GU10

**110V
240V**

GES



Se recomienda el uso de un sellador flexible para evitar posibles fisuras y/o la acumulación de suciedad.

It is recommended that a flexible sealant is used to prevent potential cracks and/or build-up of dirt.

Il est conseillé d'utiliser un produit d'étanchéité flexible pour éviter d'éventuelles fissures et/ou l'accumulation d'impuretés.

Es wird empfohlen, eine flexible Dichtung zu verwenden, um mögliche Risse und/oder die Ansammlung von Schmutz zu vermeiden.

Raccomandiamo l'uso di un collante flessibile onde evitare possibili crepature e/o l'accumulazione di sporcizia.

Recomenda-se que a junta de se faça com material flexível para evitar possíveis fissuras e/ou acumulação de sujidade.

Рекомендуется использовать мягкий герметик для избежания трещин и загрязнений.

Zaleca się użycie elastycznego środka uszczelniającego dla uniknięcia ewentualnych szczelin i/lub gromadzenia się brudu.

GES

90-1720-14-00	90-1722-14-00	90-1809-14-00	90-1813-14-00							



QR-CBC51 / MR16

GU5.3

90-1720-14-00



max. 35W



12V



01-08



QR-CBC51 / MR16

GU5.3

90-1722-14-00



max. 35W



12V



01-08

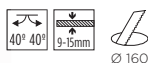

QR-CBC51 / MR16

GU5.3

90-1809-14-00



max. 50W



12V



01-08



QR-CBC51 / MR16

GU5.3

90-1813-14-00



max. 50W



12V



01-08



Accesorios / Accessoires / Accessoires / Zubehöre / Accessori / Acessórios / Аксессуары / Akcesoria



71-1881-00-00

Kit GU10



**110V
240V**



VISION

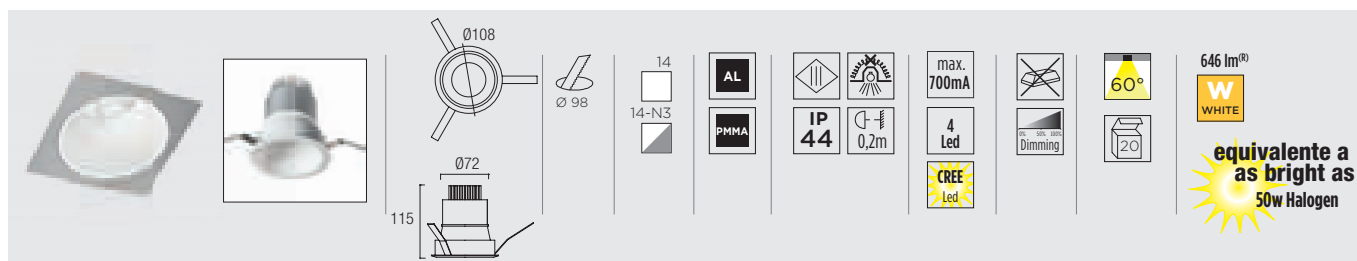

LED

Model	Beam Angle	Material	Color Temperature	Power	Dimming
90-3475-14-14	□	○	Warm W 3000K	max. 8,8W	
90-3476-14-14	□	○			
90-3476-14-N3	▣	○			

LED Blanco cálido / Warm white 700mA

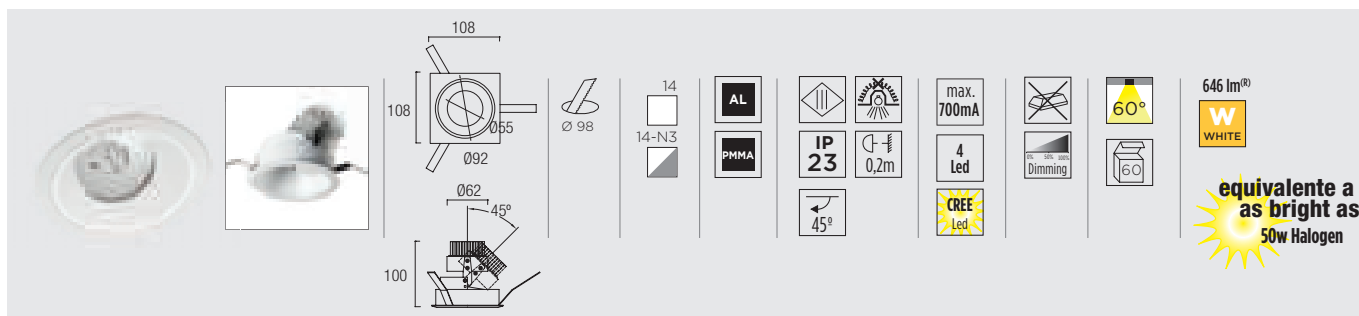
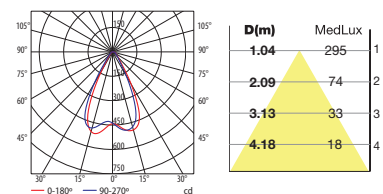

LED

Model	Beam Angle	Material	Color Temperature	Power	Dimming
90-3477-14-14	□	○	Warm W 3000K	max. 8,8W	
90-3478-14-14	□	○			
90-3478-14-N3	▣	○			

LED Blanco cálido / Warm white 700mA

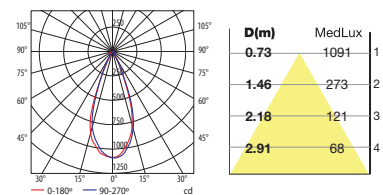



DOME

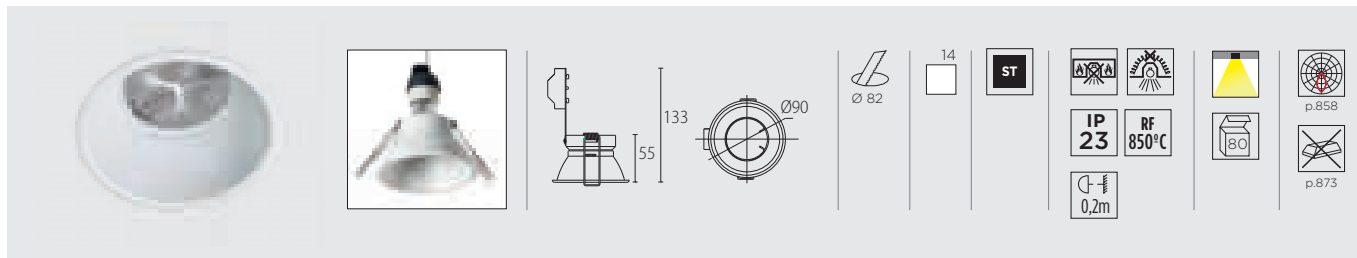

QR-CBC51 / MR16

GU5.3



QPAR-16

GU10

DN-1600-14-00

QR-CBC51 / MR16

max.50W



12V



1-8

QPAR-16

-

 110V
240V

21

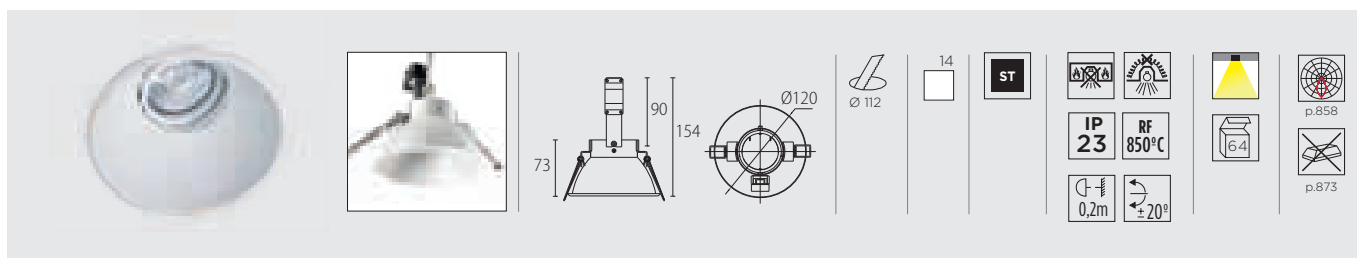

QR-CBC51 / MR16

GU5.3



QPAR-16

GU10

DN-1601-14-00

QR-CBC51 / MR16

max.50W



12V



1-8

QPAR-16

-

 110V
240V

21

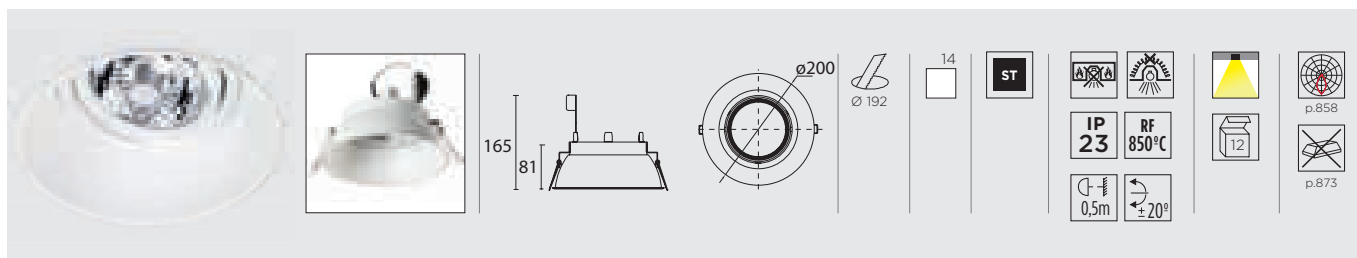

QR-111 / AR-111

G53

DN-1602-14-00

max.100W



12V

9-14 / 22-25

CDM-R111

GX8.5

DN-1603-14-00

max.70W



-

15-20

AR-111

GU10

DN-1651-14-00

-

-

 110V
240V

22-25

Accesorios / Accessories / Accessoires / Zubehöre / Accessori / Acessórios / Аксессуары / Akcesoria

ACT-9131-11-00

QR-111

ACT-9131-25-00

QR-111

ACT-9131-08-00

QR-111



ACT-9131-24-00

QR-111



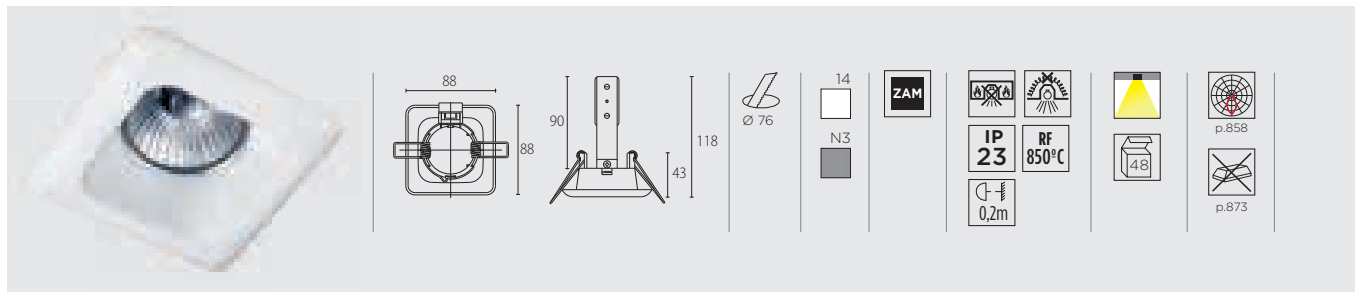

MINI EVOLUTION



QR-CBC51 / MR16

GU5.3



QPAR-16

GU10



DM-1107-14-00 <input type="checkbox"/>	QR-CBC51 / MR16	max.50W		12V			1-8
	QPAR-16		-	110V 240V			21
DM-1107-N3-00 <input type="checkbox"/>	QR-CBC51 / MR16			12V			1-8
	QPAR-16		-	110V 240V			21



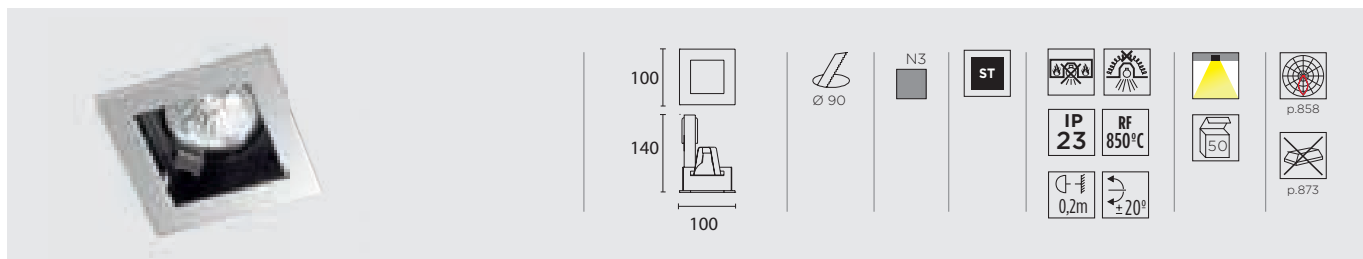

MINI

QR-CBC51 / MR16

GU5.3

DM-1105-N3-00

max.50W



12V



1-8



(max. H=60 mm)

QPAR-16

GU10

DM-1106-N3-00

max.50W

-

 110V
240V

21

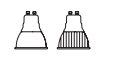

(max. H=57 mm)

 QR-CBC51
≤35W

(max. H=60 mm)

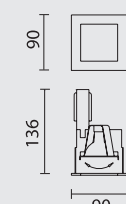

83 x 70

QR-CBC51 / MR16

GU5.3

DM-0048-N3-00

max.50W



1-8



(max. H=60 mm)

 QR-CBC51
≤35W

(max. H=60 mm)

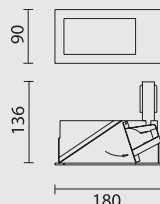

173 x 70

QR-CBC51 / MR16

GU5.3

DM-0049-N3-00

max.50W



1-8



(max. H=60 mm)

 QR-CBC51
≤35W

(max. H=60 mm)

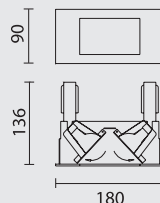

173 x 70

QR-CBC51 / MR16

GU5.3

DM-0050-N3-00

2 x max.50W



1-8



(max. H=60 mm)

PAT

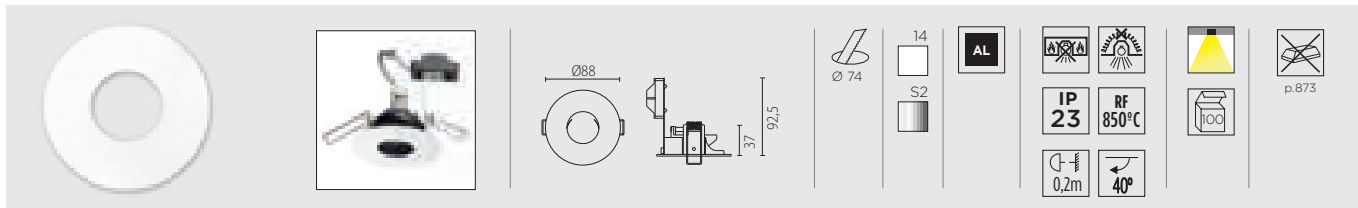

QR-CBC51 / MR16

GU5.3

DN-1695-14-00

QR-CBC51 / MR16

max.50W

12V

QPAR-16

GU10



DN-1695-S2-00

QR-CBC51 / MR16

12V

QPAR-16

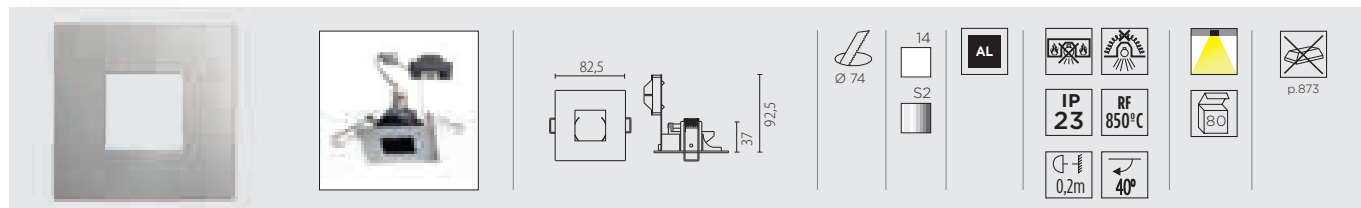
110V
240V



QR-CBC51 / MR16

GU5.3

DN-1696-14-00

QR-CBC51 / MR16

max.50W

12V

QPAR-16

GU10

DN-1696-S2-00

QR-CBC51 / MR16

12V

QPAR-16

110V
240V



PAT

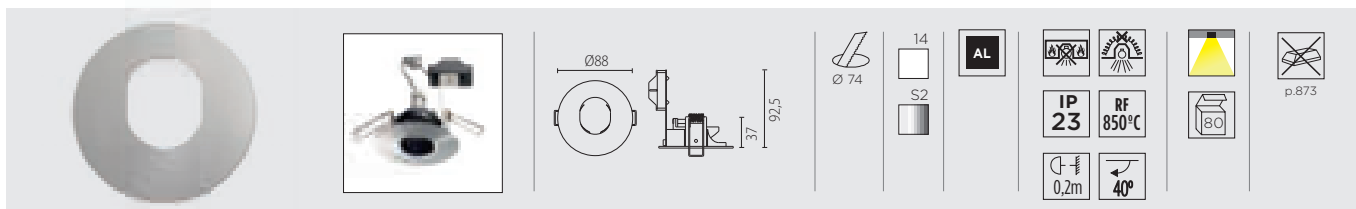

QR-CBC51 / MR16

GU5.3

DN-1697-14-00

QR-CBC51 / MR16

12V

QPAR-16

- 110V 240V

max.50W

QPAR-16

GU10

DN-1697-S2-00

QR-CBC51 / MR16

12V

QPAR-16

- 110V 240V

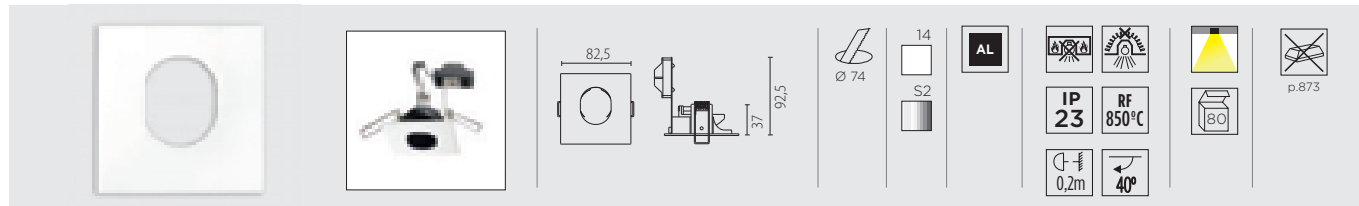

QR-CBC51 / MR16

GU5.3

DN-1698-14-00

QR-CBC51 / MR16

12V

QPAR-16

- 110V 240V

max.50W

QPAR-16

GU10

DN-1698-S2-00

QR-CBC51 / MR16

12V

QPAR-16

- 110V 240V

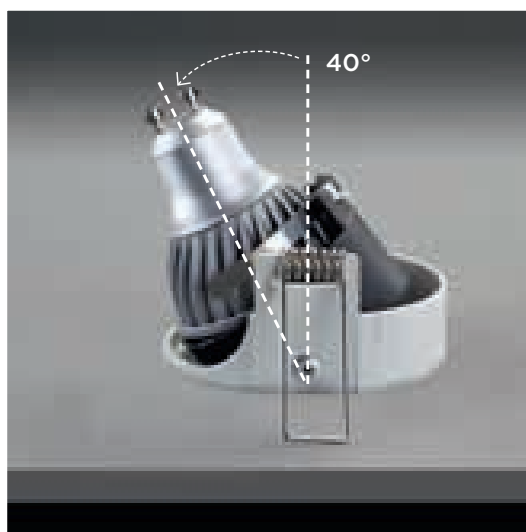



TOP



		$\varnothing 89$	$\varnothing 80$	14	AL					600 lm [®]
		$49,5$	PC	IP 44						

LED



90-1782-14-37		Warm W 3000K	5,5W	ON / OFF
----------------------	--	-----------------	------	----------

LED Blanco cálido / Warm white

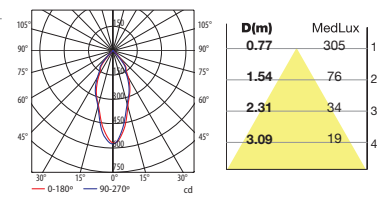



PLAY



14	AL				540 lm ^(R)	1160 lm ^(R)	
N3	PC	IP 44			7W	13W	

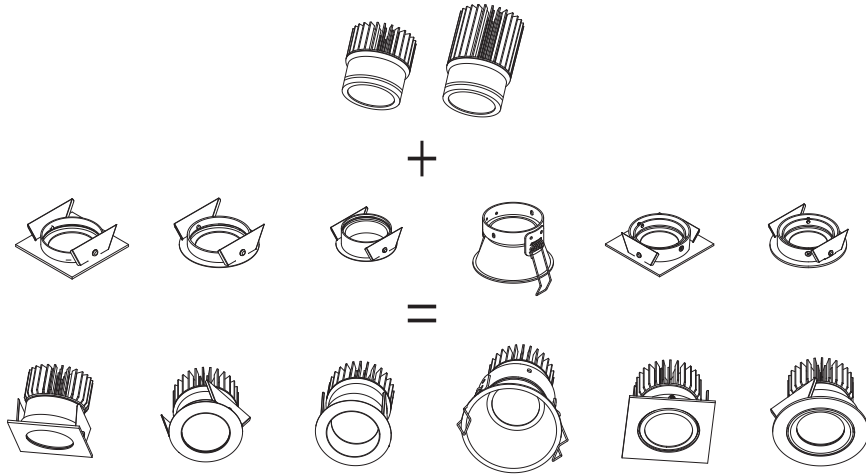

	LED		71-2909-14-37	<input type="checkbox"/>	Warm W 3000K	7W		220V 240V
		LED	71-3225-14-37	<input type="checkbox"/>	Warm W 3000K	1 Led max. 700mA	max. 7W	
Unidades eléctricas / Electrical Units / Platinas eléctricas / Netzteile / Unità Elettriche / Unidades eléctricas / Электрооборудование / Części elektryczne								862-869
	LED		71-3226-14-37	<input type="checkbox"/>	Warm W 3000K	13W		100V 240V



- 71-3283-00-00**
- 71-3284-00-00**

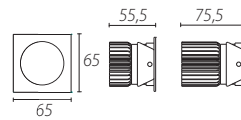
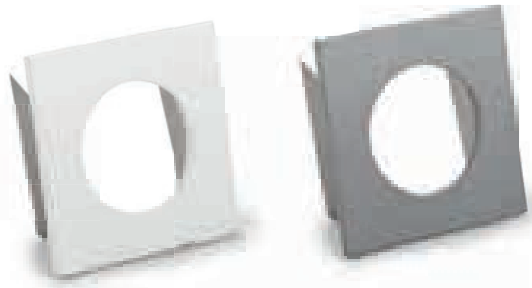

 Ø 58	71-2910-14-00 <input type="checkbox"/>	71-2910-N3-00 <input checked="" type="checkbox"/>
---	---	--

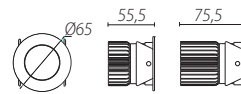
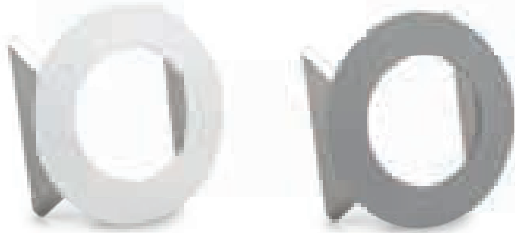

 Ø 58	71-2911-14-00 <input type="checkbox"/>	71-2911-N3-00 <input checked="" type="checkbox"/>
---	---	--

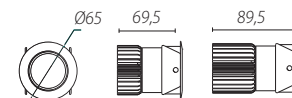
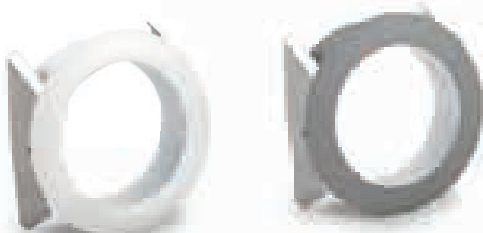

 Ø 58	71-2912-14-00 <input type="checkbox"/>	71-2912-N3-00 <input checked="" type="checkbox"/>
--	---	--

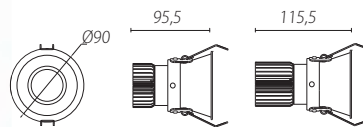

 Ø 76	71-2913-14-00 <input type="checkbox"/>	
---	---	--

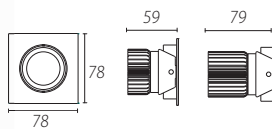
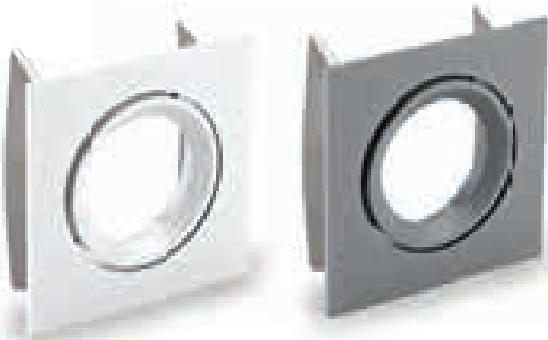

 Ø 68	 ±20°	71-2914-14-00 <input type="checkbox"/>	71-2914-N3-00 <input checked="" type="checkbox"/>
---	---	---	--

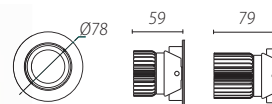
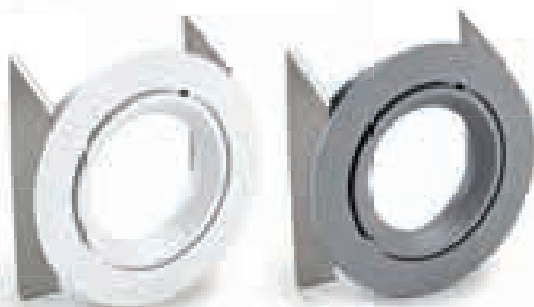

 Ø 68	 ±20°	71-2915-14-00 <input type="checkbox"/>	71-2915-N3-00 <input checked="" type="checkbox"/>
---	---	---	--

TRIMIUM MINI

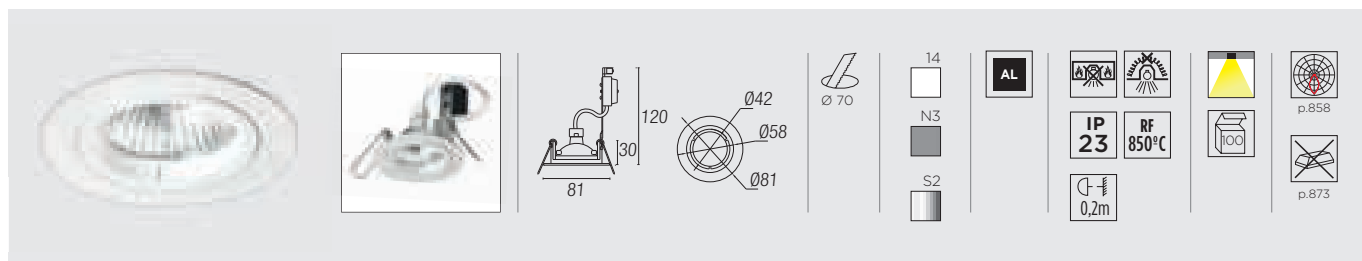

QR-CBC51 / MR16

GU5.3



QR-CBC51
≤35W

DN-0522-14-00 <input type="checkbox"/>	max.50W		12V	1-8
DN-0522-N3-00 <input type="checkbox"/>				
DN-0522-S2-00 <input type="checkbox"/>				

QPAR-16

GU10



DN-0525-14-00 <input type="checkbox"/>	max.50W	-	110V 240V	21
DN-0525-S2-00 <input type="checkbox"/>				

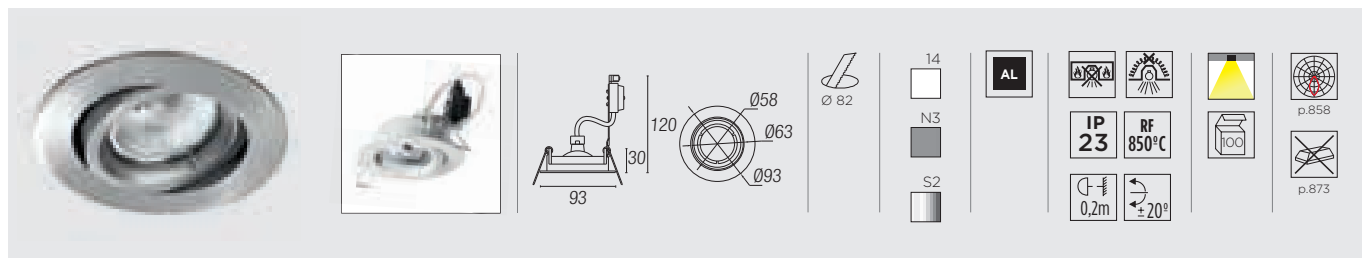

QR-CBC51 / MR16

GU5.3



QR-CBC51
≤35W

DN-0521-14-00 <input type="checkbox"/>	max.50W		12V	1-8
DN-0521-N3-00 <input type="checkbox"/>				
DN-0521-S2-00 <input type="checkbox"/>				

QPAR-16

GU10



DN-0526-14-00 <input type="checkbox"/>	max.50W	-	110V 240V	21
DN-0526-S2-00 <input type="checkbox"/>				

TRIMIUM MINI

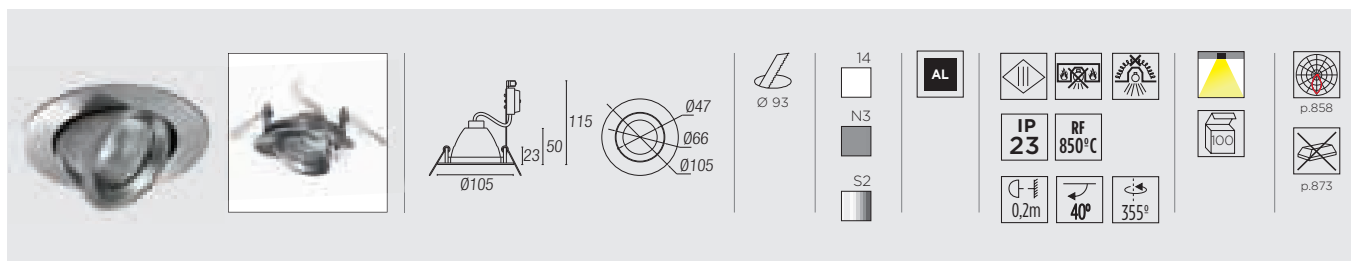

QR-CBC51 / MR16

GU5.3



QR-CBC51
≤35W

DN-0520-14-00 <input type="checkbox"/>	max.50W		12V	1-8
DN-0520-N3-00 <input type="checkbox"/>				
DN-0520-S2-00 <input type="checkbox"/>				

QPAR-16

GU10



DN-0527-14-00^(S) <input type="checkbox"/>	max.50W	-	110V 240V	21
DN-0527-S2-00^(S) <input type="checkbox"/>				

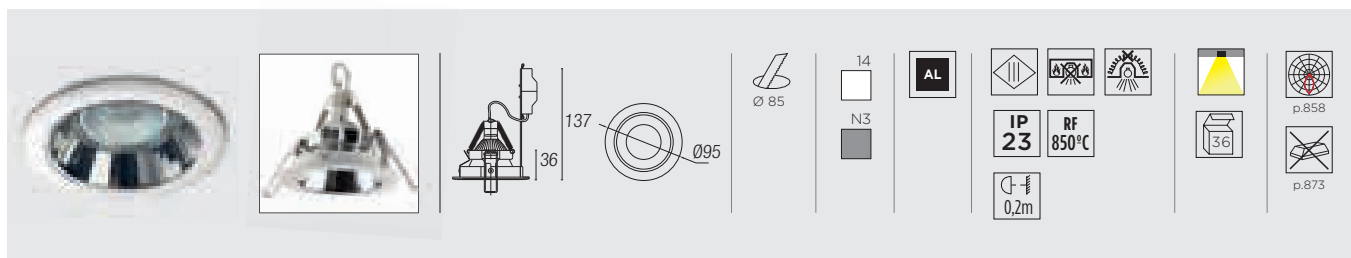

QR-CBC51 / MR16

GU5.3



QR-CBC51
≤35W

DN-0610-14-00 <input type="checkbox"/>	max.50W		12V	1-8
DN-0610-N3-00 <input type="checkbox"/>				

EIS

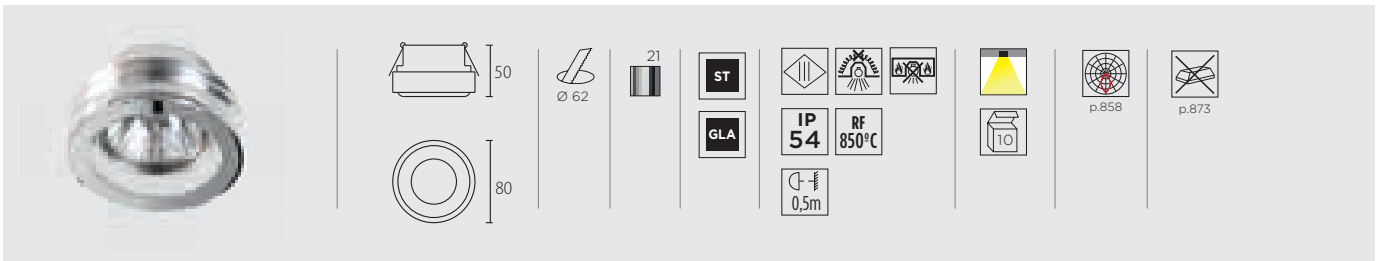

QR-CBC51 / MR16

GU5.3 	90-1689-21-37 	max.50W		12V	 1-8
--	--	---------	---	-----	---

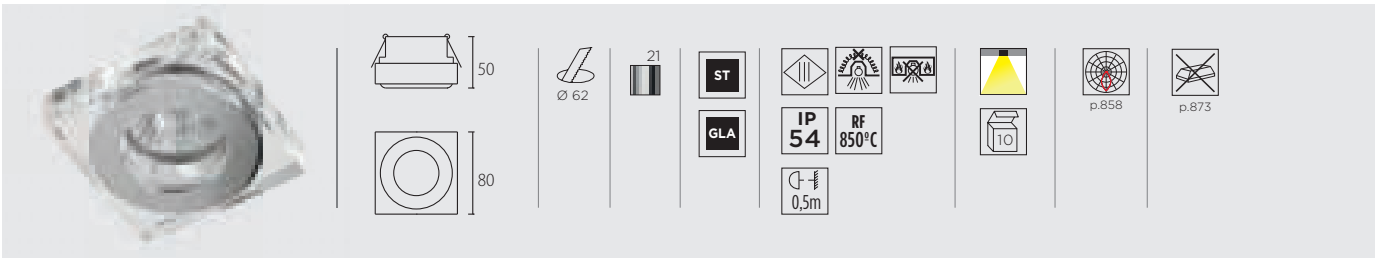

QR-CBC51 / MR16

GU5.3 	90-1690-21-37 	max.50W		12V	 1-8
--	---	---------	--	-----	--

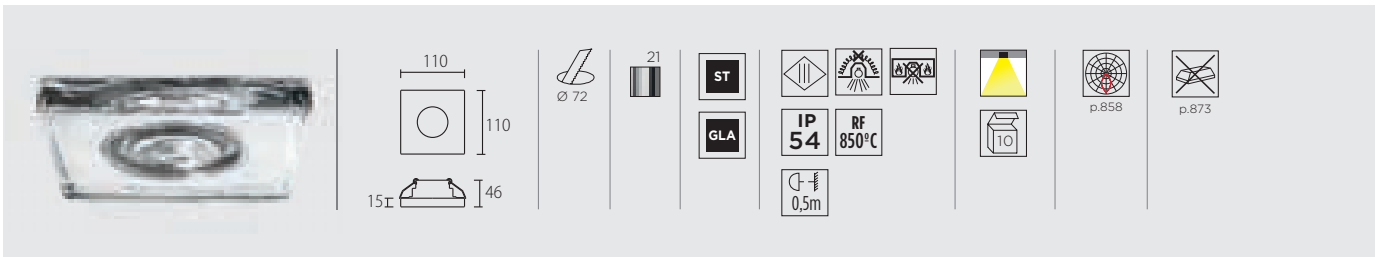

QR-CBC51 / MR16

GU5.3 	90-1792-21-37 	max.50W		12V	 1-8
--	--	---------	---	-----	---

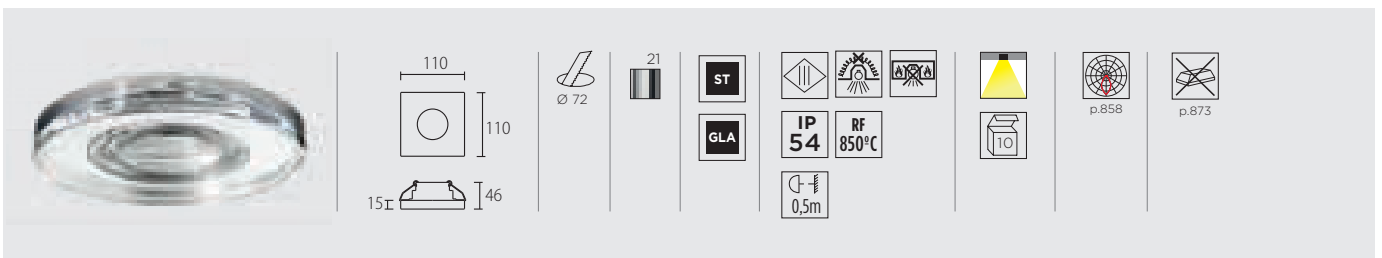

QR-CBC51 / MR16

GU5.3 	90-1789-21-37 	max.50W		12V	 1-8
--	--	---------	---	-----	---

Accesorios / Accessories / Accessoires / Zubehöre / Accessori / Acessórios / Аксессуары / Akcesoria

71-4396-00-00	Kit GU10 
----------------------	--

SPLIT

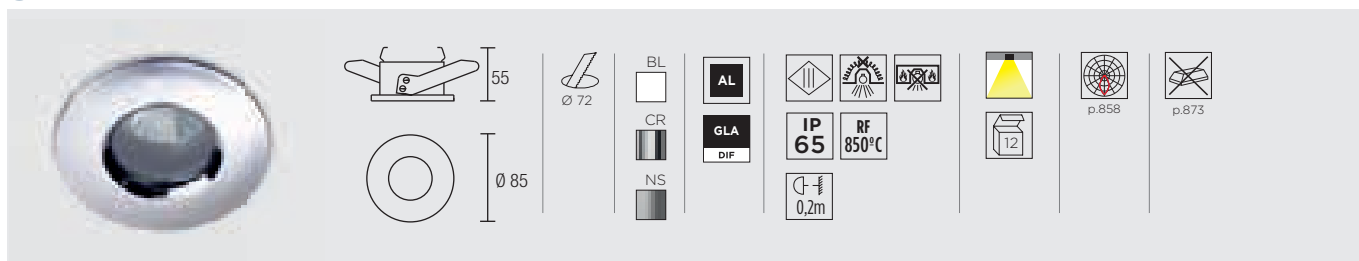

QR-CBC51 / MR16

GU5.3



320-BL	<input type="checkbox"/>	max.50W		12V	
320-CR	<input checked="" type="checkbox"/>				
320-NS	<input checked="" type="checkbox"/>				

FÓRMULA

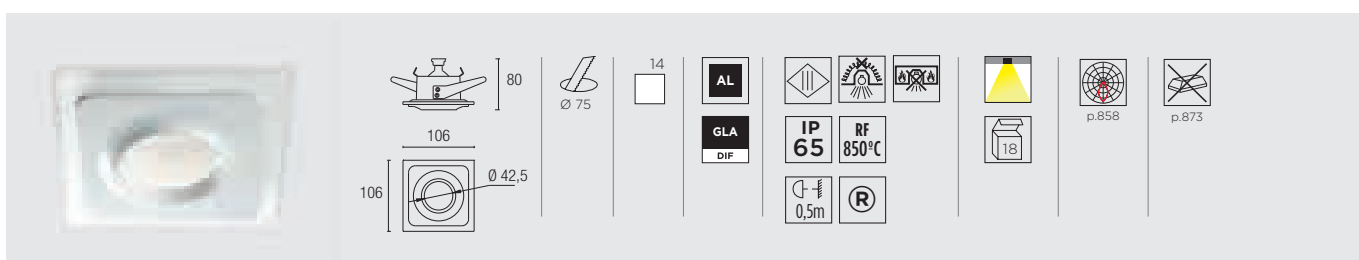

QR-CBC51 / MR16

GU5.3



90-4349-14-B9	<input type="checkbox"/>	max.50W		12V	
----------------------	--------------------------	---------	--	-----	--

Accesorios / Accessories / Accessoires / Zubehöre / Accessori / Acessórios / Аксессуары / Akcesoria

71-4396-00-00

Kit GU10



ZOE

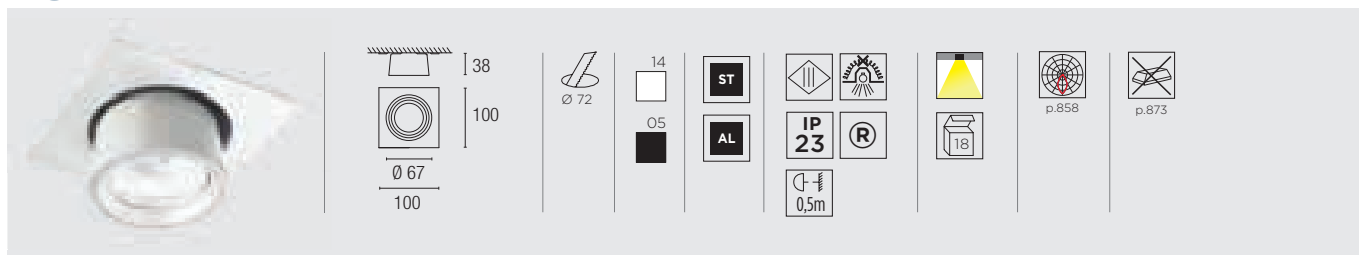

QR-CBC51 / MR16

GU5.3



(max. H=50 mm)

90-4350-05-05	<input checked="" type="checkbox"/>	max.50W		12V	
90-4350-14-14	<input type="checkbox"/>				

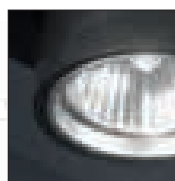

2 aros de colores incluidos
 2 coloured rings included
 2 anneaux de couleur fournis
 2 farbige Ringe inklusive
 2 anelli colorati inclusi
 2 aros coloridos incluídos
 В комплект входят 2 цветных кольца
 Obręcze w 2 kolorach w komplecie

TRIMIUM S100

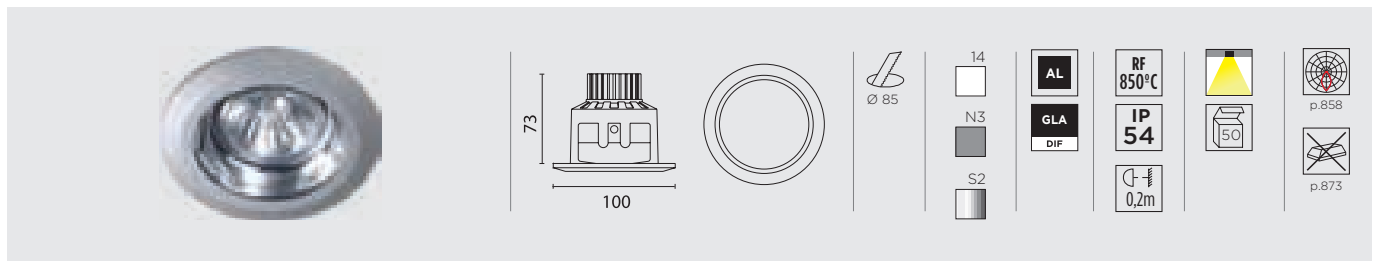

QR-CBC51 / MR16

GU5.3



DN-1003-14-B9	<input type="checkbox"/>	max.50W		12V	1-8
DN-1003-N3-B9	<input type="checkbox"/>				
DN-1003-S2-B9	<input type="checkbox"/>				

QPAR-16

GU10



DN-1012-14-B9	<input type="checkbox"/>	max.50W	-	110V 240V	21
DN-1012-S2-B9	<input type="checkbox"/>				

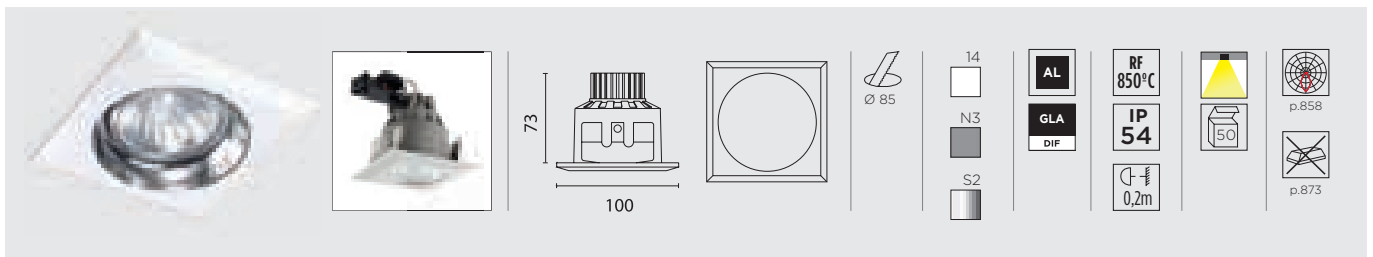

QR-CBC51 / MR16

GU5.3



DN-1009-14-B9	<input type="checkbox"/>	max.50W		12V	1-8
DN-1009-N3-B9	<input type="checkbox"/>				
DN-1009-S2-B9	<input type="checkbox"/>				

QPAR-16

GU10



DN-1016-14-B9	<input type="checkbox"/>	max.50W	-	110V 240V	21
DN-1016-S2-B9	<input type="checkbox"/>				

Accesorios / Accessories / Accessoires / Zubehöre / Accessori / Acessórios / Аксессуары / Akcesoria

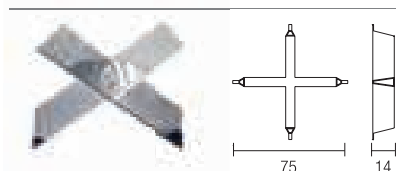

ACT-0294-00-00

Cruz de baja luminancia
 Low luminance cross louvre
 Dispositif anti-éblouissement
 Niedrigleucht-Kreuz
 Croce di bassa luminanza
 Dispositivo anti-encandeamto
 Крестообразное противоослепляющее приспособление
 Raster krzyżowy o niskiej luminancji

TRIMIUM S130

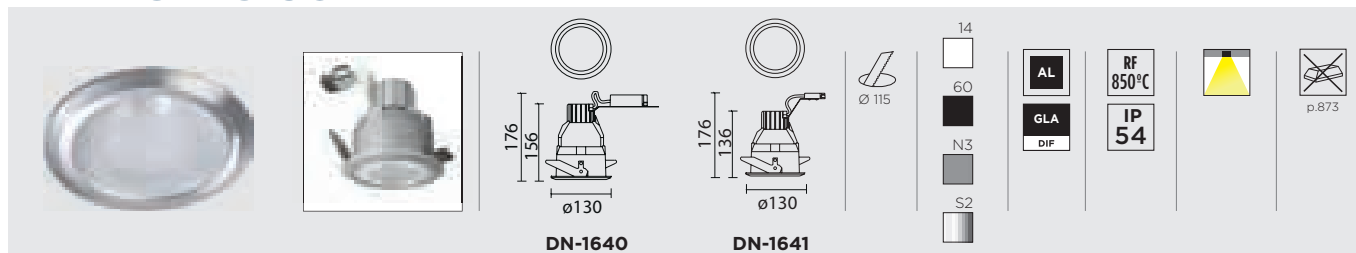

TC-TEL

GX24q-3



DN-1640-14-T2	<input type="checkbox"/>	1x26W		230V	95°
DN-1640-60-T2	<input checked="" type="checkbox"/>				
DN-1640-N3-T2	<input checked="" type="checkbox"/>				
DN-1640-S2-T2	<input checked="" type="checkbox"/>				

TC-TEL GX24q-3 1x26W

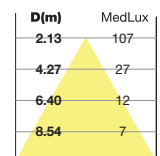
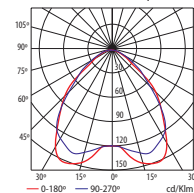

$\eta=35\%$

HIT-TC

G8.5



DN-1641-14-T2	<input type="checkbox"/>	max.70W		-	60°
DN-1641-60-T2	<input checked="" type="checkbox"/>				
DN-1641-N3-T2	<input checked="" type="checkbox"/>				
DN-1641-S2-T2	<input checked="" type="checkbox"/>				

HIT-TC G8.5 70W

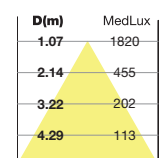
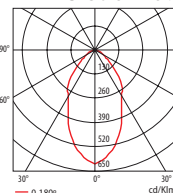

$\eta=58\%$

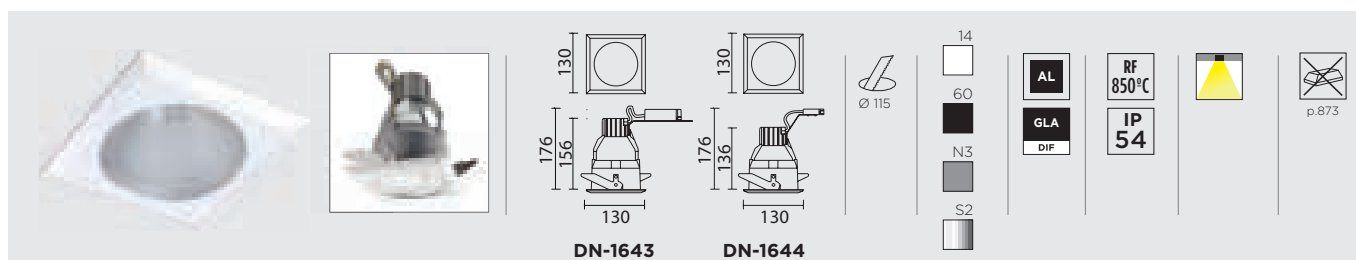

TC-TEL

GX24q-3



DN-1643-14-T2	<input type="checkbox"/>	1x26W		230V	95°
DN-1643-60-T2	<input checked="" type="checkbox"/>				
DN-1643-N3-T2	<input checked="" type="checkbox"/>				
DN-1643-S2-T2	<input checked="" type="checkbox"/>				

TC-TEL GX24q-3 1x26W

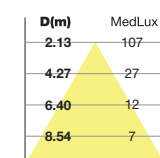
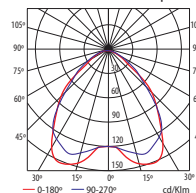

$\eta=35\%$

HIT-TC

G8.5

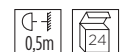

DN-1644-14-T2	<input type="checkbox"/>	max.70W		-	60°
DN-1644-60-T2	<input checked="" type="checkbox"/>				
DN-1644-N3-T2	<input checked="" type="checkbox"/>				
DN-1644-S2-T2	<input checked="" type="checkbox"/>				

HIT-TC G8.5 70W

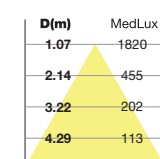
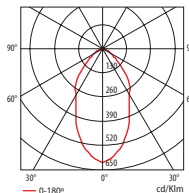

$\eta=58\%$

CAMALEON

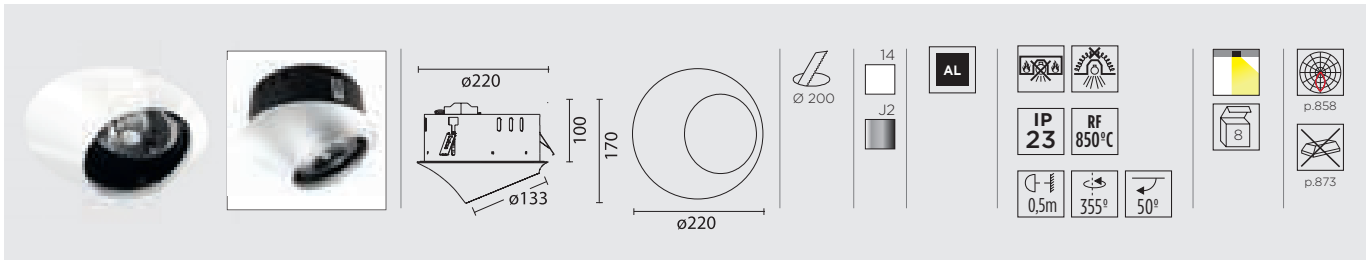

QR-111 / AR-111

G53



(max. H=100 mm)

DN-1302-14-00 <input type="checkbox"/>	max. 100W		12V		09-14 / 22-25
DN-1302-J2-00 ^(S) <input type="checkbox"/>					

CDM-R111

GX8.5

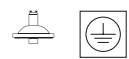

DN-1305-14-00 <input type="checkbox"/>	max. 70W		-		15-20
DN-1305-J2-00 ^(S) <input type="checkbox"/>					

AR-111

GU10



(max. H=100 mm)

DN-1650-14-00 <input type="checkbox"/>	-		110V 240V		22-25
DN-1650-J2-00 ^(S) <input type="checkbox"/>					

Accesorios / Accessories / Accessoires / Zubehöre / Accessori / Acessórios / Аксессуары / Akcesoria

	ACT-9131-11-00	QR-111			ACT-9131-25-00	QR-111	
	ACT-9131-08-00	QR-111			ACT-9131-24-00	QR-111	

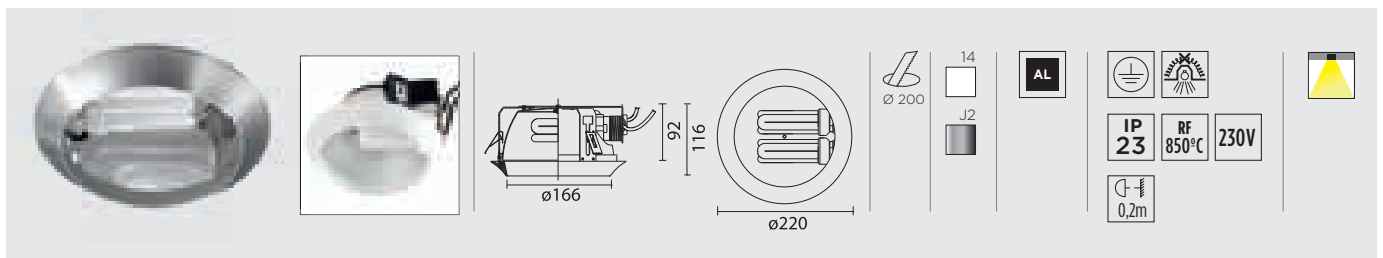

TC-TEL

GX24q-3



DN-1301-14-00 ^(S) <input type="checkbox"/>	2x26/32W	
DN-1301-J2-00 ^(S) <input type="checkbox"/>		

TC-TEL GX24q-3

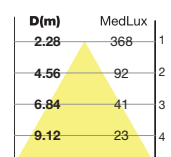
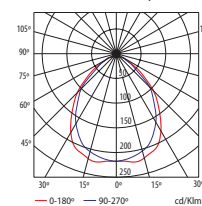

η=50%

CAMALEON

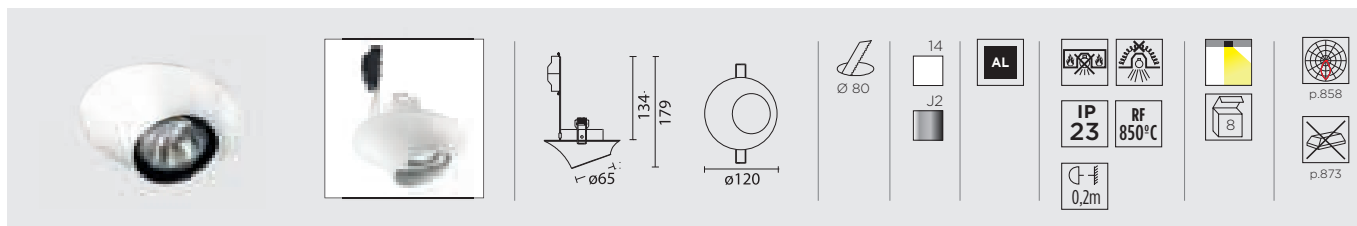

QR-CBC51 / MR16

GU5.3



(max. H=60 mm)

DN-1304-14-00 <input type="checkbox"/>	QR-CBC51 / MR16	max.50W		12V			1-8
	QPAR-16		-	110V 240V			21
DN-1304-J2-00 ^(S) <input type="checkbox"/>	QR-CBC51 / MR16	max.50W		12V			1-8
	QPAR-16		-	110V 240V			21

QPAR-16

GU10



(max. H=57 mm)

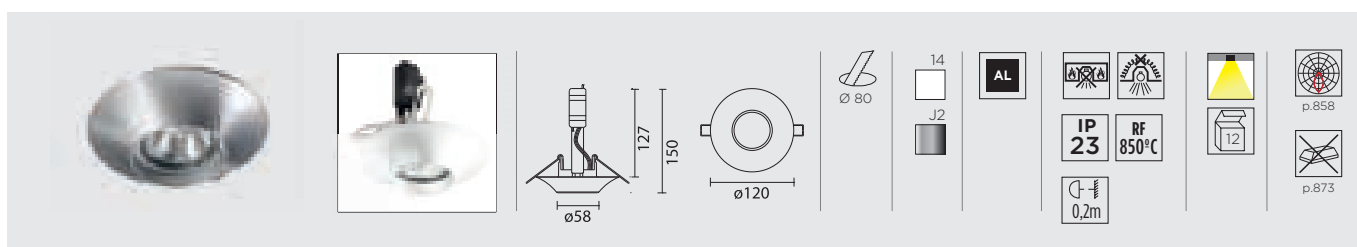

QR-CBC51 / MR16

GU5.3



DN-1303-14-00 <input type="checkbox"/>	QR-CBC51 / MR16	max.50W		12V			1-8
	QPAR-16		-	110V 240V			21
DN-1303-J2-00 ^(S) <input type="checkbox"/>	QR-CBC51 / MR16	max.50W		12V			1-8
	QPAR-16		-	110V 240V			21

QPAR-16

GU10





DELTA COB



DELTA COB

NEW



LED



90-3242-14-37	<input type="checkbox"/>	Warm W 3000K	26W	
90-3242-N3-37	<input type="checkbox"/>			



LED



90-3243-14-37	<input type="checkbox"/>	Warm W 3000K	26W	
90-3243-N3-37	<input type="checkbox"/>			

LED Blanco cálido / Warm white 40° - 26W

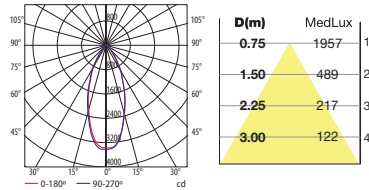

Accesorios / Accessories / Accessoires / Zubehöre / Accessori / Acessórios / Аксессуары / Akcesoria

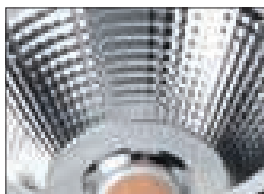

71-2918-00-00



LED Blanco cálido / Warm white 20° - 26W

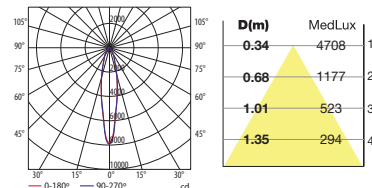

DELTA COB

NEW

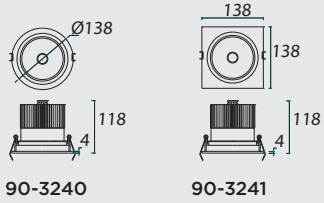

LED



90-3240-14-37	<input type="checkbox"/>	Warm W 3000K	38W	
90-3240-N3-37	<input type="checkbox"/>			



LED



90-3241-14-37	<input type="checkbox"/>	Warm W 3000K	38W	
90-3241-N3-37	<input type="checkbox"/>			

LED Blanco cálido / Warm white 40° - 38W

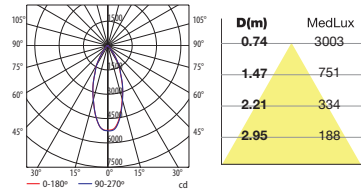

Accesorios / Accessories / Accessoires / Zubehöre / Accessori / Acessórios / Аксессуары / Akcesoria

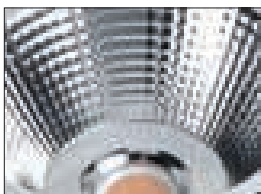

71-2918-00-00



LED Blanco cálido / Warm white 20° - 38W

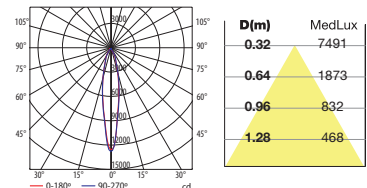

DELTA 3

equivalente a as bright as 50w Halogen



LED



90-1923-S2-N3	<input checked="" type="checkbox"/>		15°	Warm W 3000K	max. 6,6W	
90-1884-S2-N3	<input checked="" type="checkbox"/>		40°			



LED



90-1924-S2-N3	<input checked="" type="checkbox"/>		15°	Warm W 3000K	max. 6,6W	
90-1895-S2-N3	<input checked="" type="checkbox"/>		40°			



LED



90-1925-S2-N3	<input checked="" type="checkbox"/>		15°	Warm W 3000K	max. 6,6W	
90-1914-S2-N3	<input checked="" type="checkbox"/>		40°			

DELTA 6

equivalente a as bright as QR-111 50w



LED



90-1888-S2-N3	<input checked="" type="checkbox"/>		40°	Warm W 3000K	max. 13,2	
----------------------	-------------------------------------	--	-----	--------------	--------------	--



LED



90-1898-S2-N3	<input checked="" type="checkbox"/>		40°	Warm W 3000K	max. 13,2	
----------------------	-------------------------------------	--	-----	--------------	--------------	--

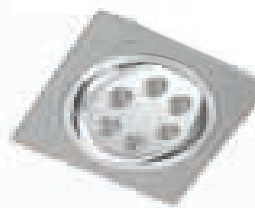

LED



90-1921-S2-N3	<input checked="" type="checkbox"/>		40°	Warm W 3000K	max. 13,2	
----------------------	-------------------------------------	--	-----	--------------	--------------	--

DELTA 9

S2-N3
 AL
 PMMA
 DIF
 IP 23
 20° 20°
 0,2m
 0-30mm
 max. 700mA
 9 Led
 CREE Led
 Dimming
 1432 lm^(R)
 W WHITE
 3 YEAR WARRANTY
 3 ANOS GARANTIA
 equivalente a as bright as QR-111 100w

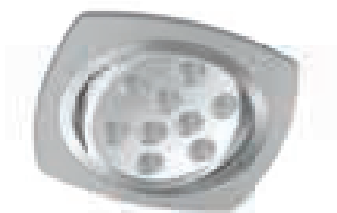

LED

90-1893-S2-N3

40°

 Warm W
3000K

 max.
19,8W

LED

90-1902-S2-N3

40°

 Warm W
3000K

 max.
19,8W

LED



90-1922-S2-N3

40°

 Warm W
3000K

 max.
19,8W

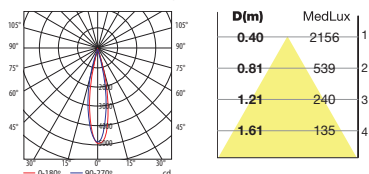

DELTA 3
LED Blanco cálido / Warm white 700 mA

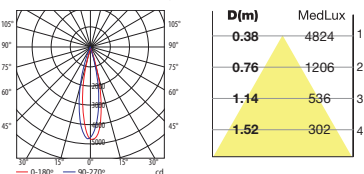

DELTA 6
LED Blanco cálido / Warm white 700 mA

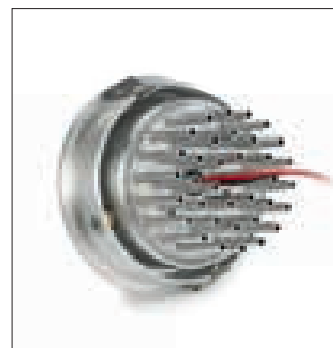
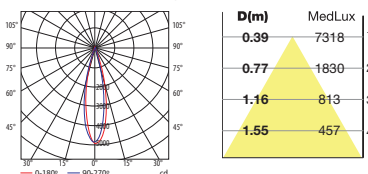

DELTA 9
LED Blanco cálido / Warm white 700 mA





CARDEX C LED

NEW

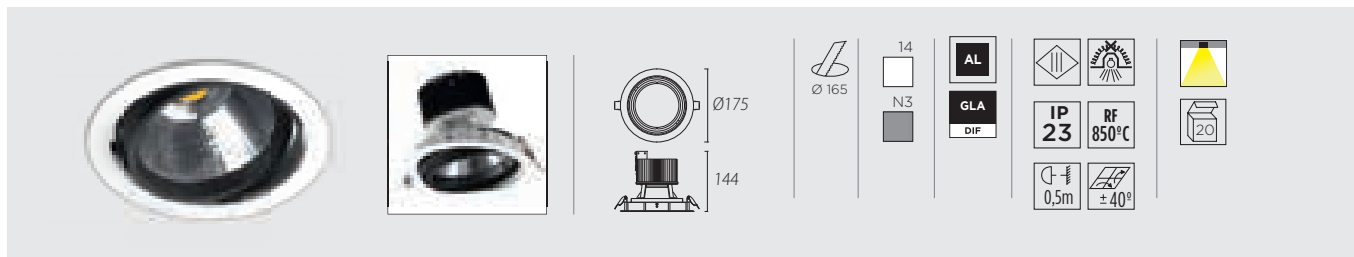

LED

Estándar
 Zhaga /
 Zhaga
 Standard

90-3291-14-37	<input type="checkbox"/>	2000 lm ^(N)	3000K	CRI>80	12°	26W	
90-3291-N3-37	<input type="checkbox"/>				24°		
90-3292-14-37	<input type="checkbox"/>				38°		
90-3292-N3-37	<input type="checkbox"/>				12°		
90-3293-14-37	<input type="checkbox"/>				24°		
90-3293-N3-37	<input type="checkbox"/>				38°		
90-3294-14-37	<input type="checkbox"/>		4000K	CRI>80	12°	24W	
90-3294-N3-37	<input type="checkbox"/>				24°		
90-3295-14-37	<input type="checkbox"/>				38°		
90-3295-N3-37	<input type="checkbox"/>				12°		
90-3296-14-37	<input type="checkbox"/>				24°		
90-3296-N3-37	<input type="checkbox"/>				38°		
90-3297-14-37	<input type="checkbox"/>	3000K	CRI>90	12°	23W		
90-3297-N3-37	<input type="checkbox"/>			24°			
90-3298-14-37	<input type="checkbox"/>			38°			
90-3298-N3-37	<input type="checkbox"/>			12°			
90-3299-14-37	<input type="checkbox"/>			24°			
90-3299-N3-37	<input type="checkbox"/>			38°			
90-3501-14-37	<input type="checkbox"/>	3000 lm ^(N)	3000K	CRI>80	12°		28W
90-3501-N3-37	<input type="checkbox"/>				24°		
90-3502-14-37	<input type="checkbox"/>				38°		
90-3502-N3-37	<input type="checkbox"/>				12°		
90-3503-14-37	<input type="checkbox"/>				24°		
90-3503-N3-37	<input type="checkbox"/>				38°		
90-3504-14-37	<input type="checkbox"/>		4000K	CRI>80	12°	26W	
90-3504-N3-37	<input type="checkbox"/>				24°		
90-3505-14-37	<input type="checkbox"/>				38°		
90-3505-N3-37	<input type="checkbox"/>				12°		
90-3506-14-37	<input type="checkbox"/>				24°		
90-3506-N3-37	<input type="checkbox"/>				38°		
90-3507-14-37	<input type="checkbox"/>	3000K	CRI>90	12°	33W		
90-3507-N3-37	<input type="checkbox"/>			24°			
90-3508-14-37	<input type="checkbox"/>			38°			
90-3508-N3-37	<input type="checkbox"/>			12°			
90-3509-14-37	<input type="checkbox"/>			24°			
90-3509-N3-37	<input type="checkbox"/>			38°			

Equipos / Gears / Dispositifs / Treiber / Dispositivi / Equipamentos / Устройства / Osprzęt



71-2476-00-00

 1 driver =
1 Cardex C Led

 Driver ON / OFF
 220-240 VAC

32 x 46 x 190 mm

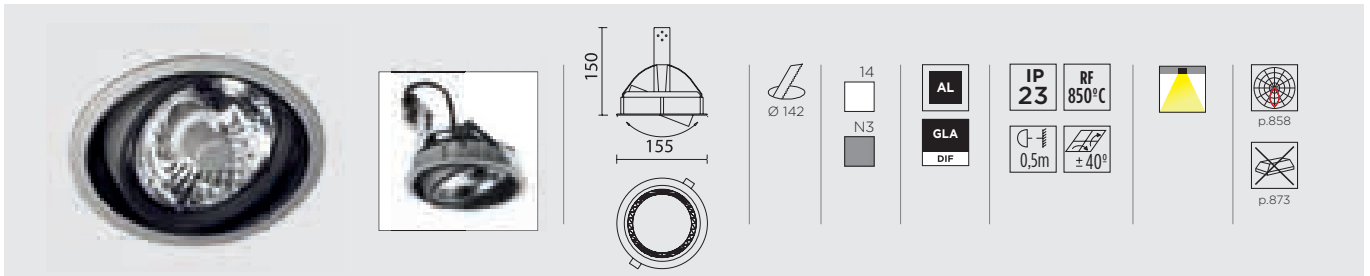
CARDEX C



QR-111 / AR-111

G53 (max. H=77 mm)	DN-0270-14-00 <input type="checkbox"/>	max.100W		12V	9-14/22-25
	DN-0270-N3-00 <input type="checkbox"/>				

HIT-T G12 70W 10°

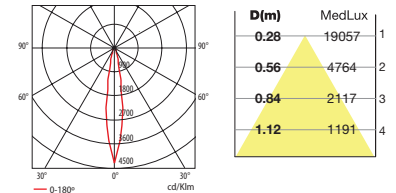

CDM-R111

GX8.5 (max. H=77 mm)	DN-0275-14-00 <input type="checkbox"/>	max.70W		-	15-20
	DN-0275-N3-00 <input type="checkbox"/>				

HIT-T G12 70W 24°

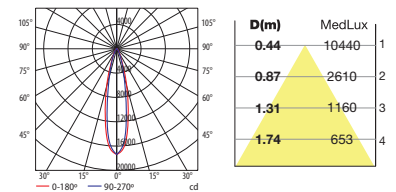

HIT-T

G12 HIT-T 150W 	DN-0274-14-00 <input type="checkbox"/>	max.150W		-	10°
	DN-0274-N3-00 <input type="checkbox"/>				24°
	DN-1653-14-00 <input type="checkbox"/>				45°
	DN-1653-N3-00 <input type="checkbox"/>				
	DN-0273-14-00 <input type="checkbox"/>				
	DN-0273-N3-00 <input type="checkbox"/>				

HIT-T G12 70W 45°

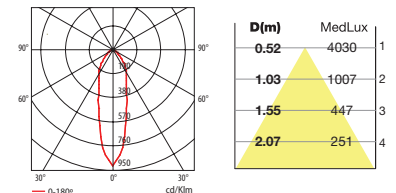

AR-111

GU10 (max. H=100 mm)	DN-1652-14-00 <input type="checkbox"/>	-	-	110V 240V	22-25
	DN-1652-N3-00 <input type="checkbox"/>				

Accesorios / Accessories / Accessoires / Zubehöre / Accessori / Acessórios / Аксессуары / Акcesoria

	ACT-0451-00-00	HIT-T LED		ACT-0454-00-00	HIT-T LED
	ACT-9131-11-00	QR-111		ACT-9131-25-00	QR-111
	ACT-0452-00-00	HIT-T LED		ACT-0453-00-00	HIT-T LED
	ACT-9131-08-00	QR-111		ACT-9131-24-00	QR-111
	ACT-9180-60-00	HIT-T LED		ACT-9180-60-00	HIT-T LED

CARDEX E

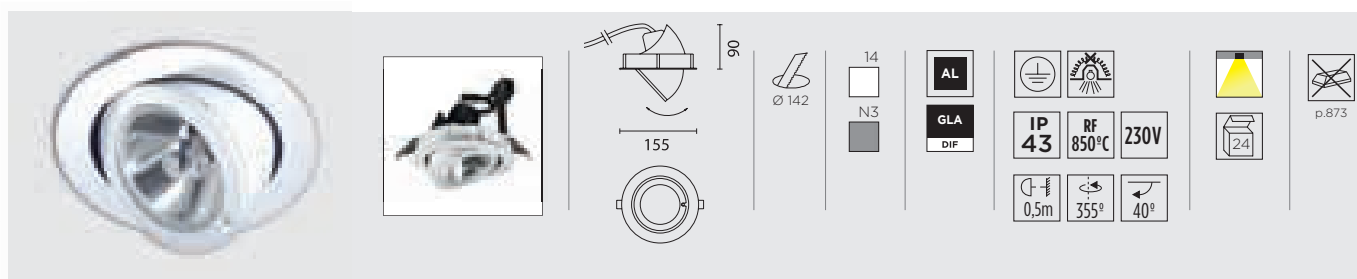

HIT-TC

G8.5



DN-0269-14-00	<input type="checkbox"/>	max. 70W		55°
DN-0269-N3-00	<input type="checkbox"/>			

HIT-TC G8.5 70W

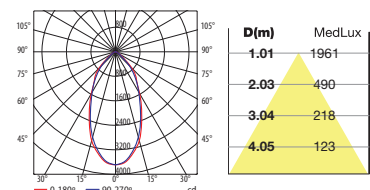

Placas de montaje decorativo / Mounting decorative plates / Plaques de montage décoratives / Dekorative Montagetafeln / Placche di montaggio decorativo / Placas de montagem decorativas / Панели для декоративного монтажа / Dekoracyjne płyty montażowe (CARDEX C /CARDEX E)



ACT-0065-14-00

ACT-0065-N3-00



ACT-0066-14-00

ACT-0066-N3-00

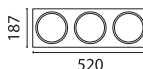

ACT-0067-14-00

ACT-0067-N3-00



ACT-0068-14-00

ACT-0068-N3-00

MULTIDIR

AMICHI STORE. MADRID, SPAIN





MULTIDIR EVO



POSITION
1



POSITION
2



POSITION
3



POSITION
4



MULTIDIR EVO



CDM-R111
GX8.5

AR-111 GU10
LEDS-C4

QR-111
G53



LED
Estándar Zhaga
Zhaga Standard

HIT-TC
G8.5



QR-CBC51
GU5.3

QPAR-16





+

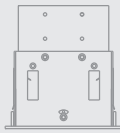

=

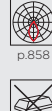
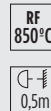
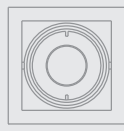

p.858



p.873



LED

Estándar
Zhaga /
Zhaga
Standard



71-2965-00-37	2000 lm ^(N)	3000K	CRI>80	12°	26W					
71-2966-00-37				24°						
71-2967-00-37				38°						
71-2968-00-37				12°						
71-2969-00-37				24°						
71-2970-00-37				38°						
71-3515-00-37		3000K	CRI>90	12°	23W					
71-3516-00-37				24°						
71-3517-00-37				38°						
71-2971-00-37				3000K			CRI>80	12°	28W	
71-2972-00-37								24°		
71-2973-00-37								38°		
71-2974-00-37	12°									
71-2975-00-37	24°									
71-2976-00-37	38°									
71-3518-00-37	3000K		CRI>90	12°	33W					
71-3519-00-37				24°						
71-3520-00-37				38°						

Equipos / Gears / Dispositifs / Treiber / Dispositivi / Equipamentos / Устройства / Osprzęt



71-2476-00-00	1 driver = 1 Multidir Evo LED	Driver ON / OFF 220-240 VAC	32 x 46 x 190 mm
----------------------	----------------------------------	--------------------------------	------------------



HIT-TC

G8.5



71-2963-00-37	max. 70W		-	10°
71-3224-00-37				24°
71-2964-00-37				45°

QR-111 / AR-111

G53



71-2956-00-00	max.100W		12V		9-14/22-25
----------------------	----------	--	-----	--	------------

CDM-R111

GX8.5



71-2955-00-00	max.70W		-		15-20
----------------------	---------	--	---	--	-------

AR-111

GU10



71-2954-00-00	-	-	110V 240V		22-25
----------------------	---	---	--------------	--	-------

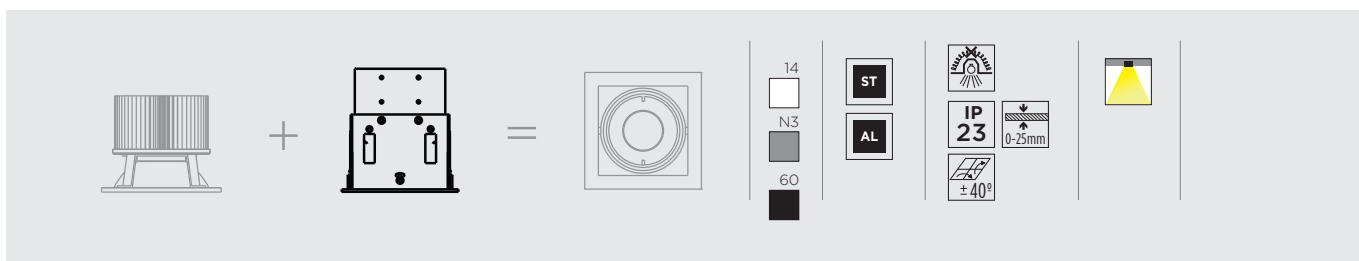

MULTIDIR EVO L TRIM



	 180 x 180		71-2948-14-00 <input type="checkbox"/> 71-2948-N3-00 <input type="checkbox"/> 71-2948-60-00 <input type="checkbox"/>
	 324 x 180		71-2949-14-00 <input type="checkbox"/> 71-2949-N3-00 <input type="checkbox"/> 71-2949-60-00 <input type="checkbox"/>
	 468 x 180		71-2950-14-00 <input type="checkbox"/> 71-2950-N3-00 <input type="checkbox"/> 71-2950-60-00 <input type="checkbox"/>

MULTIDIR EVO L TRIMLESS



	 155 x 155		71-2951-14-00 <input type="checkbox"/> 71-2951-60-00 <input type="checkbox"/>
	 299 x 155		71-2952-14-00 <input type="checkbox"/> 71-2952-60-00 <input type="checkbox"/>
	 443 x 155		71-2953-14-00 <input type="checkbox"/> 71-2953-60-00 <input type="checkbox"/>

Accesorios / Accessories / Accessoires / Zubehöre / Accessori / Acessórios / Аксессуары / Akcesoria

	ACT-0451-00-00	HIT-TC		ACT-0454-00-00	HIT-TC
		LED			LED
	ACT-9131-11-00	QR-111		ACT-9131-25-00	QR-111
	ACT-0452-00-00	HIT-TC		ACT-0453-00-00	HIT-TC
		LED			LED
	ACT-9131-08-00	QR-111		ACT-9131-24-00	QR-111
				ACT-9180-60-00	HIT-TC
					LED

MULTIDIR EVO L

POSITION 1

POSITION 2

POSITION 3

POSITION 4

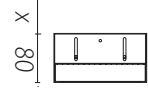
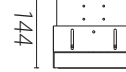
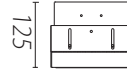
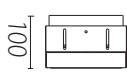

Code	Socket	Options	Position 1	Position 2	Position 3	Position 4
71-2954-00-00	GU10	ACT-FLL-011, 013, 015, 017, 030, 031, 032, 033	X	✓ H max. 80mm	✓ H max. 100mm	✓
71-2955-00-00	GX8,5	-	X	✓	✓	✓
71-2956-00-00	G53	-	✓ H max. 77mm	✓ H max. 102mm	✓ H max. 122mm	✓
71-2963-00-37	G8,5	-	X	✓	✓	✓
71-3224-00-37						
71-2964-00-37						
71-2965-00-37	LED ZHAGA	-	X	X	✓	✓
71-2966-00-37						
71-2967-00-37						
71-2968-00-37						
71-2969-00-37						
71-2970-00-37						
71-3515-00-37						
71-3516-00-37						
71-3517-00-37						
71-2971-00-37						
71-2972-00-37						
71-2973-00-37						
71-2974-00-37						
71-2975-00-37						
71-2976-00-37						
71-3518-00-37						
71-3519-00-37						
71-3520-00-37						

MULTIDIR EVO S

NEW

ST

RF 850°C

AL

0,2m

10

p.858

p.873



QR-CBC51 / MR16

GU5.3

71-3212-00-00

max. 50W



12V



QR-CBC51 >35W

QPAR-16

GU10

71-2954-00-00

max. 50W

-

110V 240V



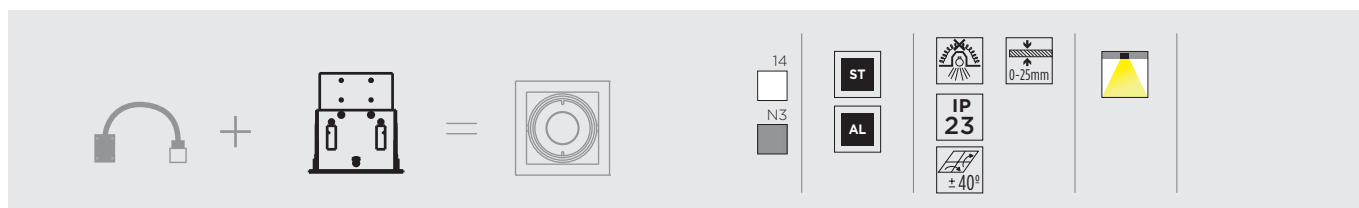

MULTIDIR EVO S TRIM



71-2942-14-00	<input type="checkbox"/>
71-2942-N3-00	<input type="checkbox"/>
71-2942-60-00	<input checked="" type="checkbox"/>



71-2943-14-00	<input type="checkbox"/>
71-2943-N3-00	<input type="checkbox"/>
71-2943-60-00	<input checked="" type="checkbox"/>

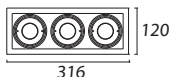

71-2944-14-00	<input type="checkbox"/>
71-2944-N3-00	<input type="checkbox"/>
71-2944-60-00	<input checked="" type="checkbox"/>

MULTIDIR EVO S TRIMLESS

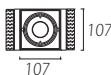

71-2945-14-00	<input type="checkbox"/>
71-2945-60-00	<input checked="" type="checkbox"/>

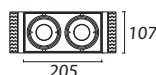

71-2946-14-00	<input type="checkbox"/>
71-2946-60-00	<input checked="" type="checkbox"/>

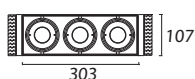

71-2947-14-00	<input type="checkbox"/>
71-2947-60-00	<input checked="" type="checkbox"/>

MULTIDIR EVO S

POSITION 1

POSITION 2

POSITION 3

POSITION 4

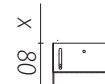
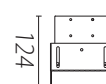
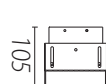
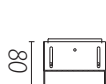

71-2954-00-00	GU10	-	✓	H max. 50mm	✓	H max. 75mm	✓	H max. 95mm	✓
71-2956-00-00	GU5.3	-	✗		✓	H max. 60mm	✓	H max. 80mm	✓

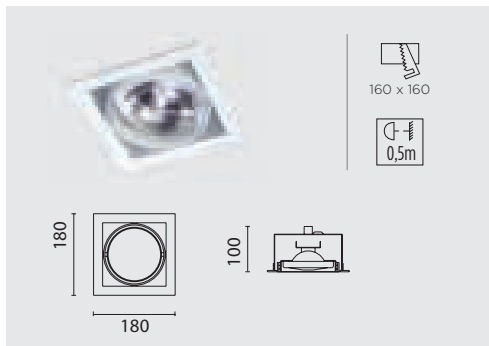
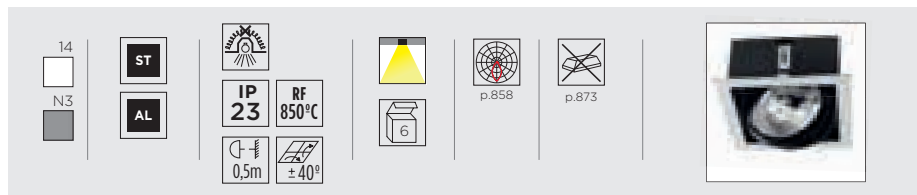

QR-111 / AR-111

G53	DM-0061-14-00	<input type="checkbox"/>	max. 100W			9-14/ 22-25
	DM-0061-N3-00	<input type="checkbox"/>				
		QR-111>65W				

AR-111

GU10	DM-1155-14-00	<input type="checkbox"/>	-	-		22-25
	DM-1155-N3-00	<input type="checkbox"/>				

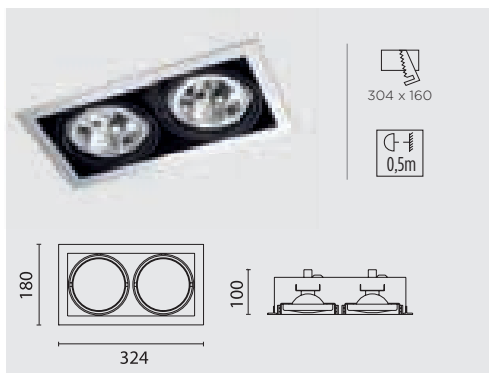

QR-111 / AR-111

G53	DM-0062-14-00	<input type="checkbox"/>	2 x max.100W			9-14/ 22-25
	DM-0062-N3-00	<input type="checkbox"/>				
		QR-111>65W				

AR-111

GU10	DM-1156-14-00	<input type="checkbox"/>	2 x -	-		22-25
	DM-1156-N3-00	<input type="checkbox"/>				

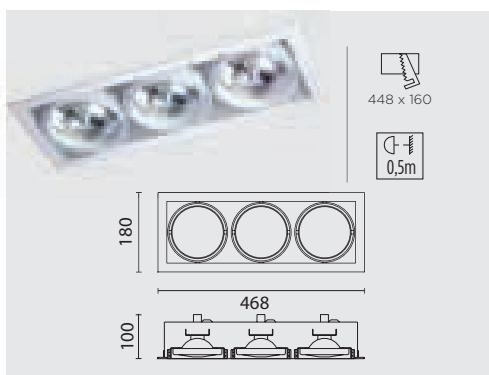

QR-111 / AR-111

G53	DM-0063-14-00	<input type="checkbox"/>	3 x max.100W			9-14/ 22-25
	DM-0063-N3-00	<input type="checkbox"/>				
		QR-111>65W				

AR-111

GU10	DM-1157-14-00	<input type="checkbox"/>	3 x -	-		22-25
	DM-1157-N3-00	<input type="checkbox"/>				

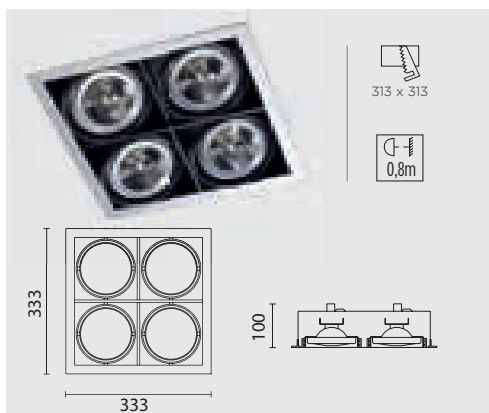

QR-111 / AR-111

G53	DM-0064-14-00	<input type="checkbox"/>	4 x max.100W			9-14/ 22-25
	DM-0064-N3-00	<input type="checkbox"/>				
		QR-111>65W				

AR-111

GU10	DM-1158-14-00	<input type="checkbox"/>	4 x -	-		22-25
	DM-1158-N3-00	<input type="checkbox"/>				



Accesorios / Accessories / Accessoires / Zubehöre / Accessori / Acessórios / Аксессуары / Akcesoria



ACT-9131-11-00

QR-111



ACT-9131-25-00

QR-111



ACT-9131-08-00

QR-111



ACT-9131-24-00

QR-111



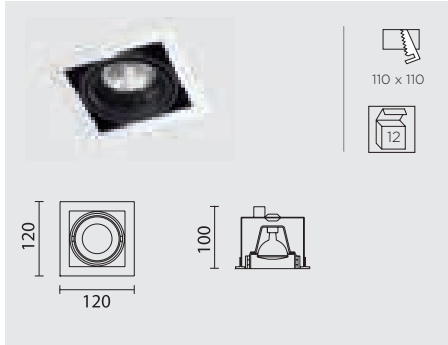
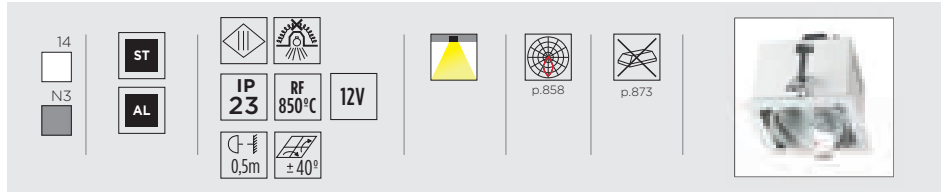

QR-CBC51 / MR16

GU5.3



QR-CBC51 >35W

max. H=55mm

DM-0053-14-00	<input type="checkbox"/>	max. 50W		1-8
DM-0053-N3-00	<input type="checkbox"/>			

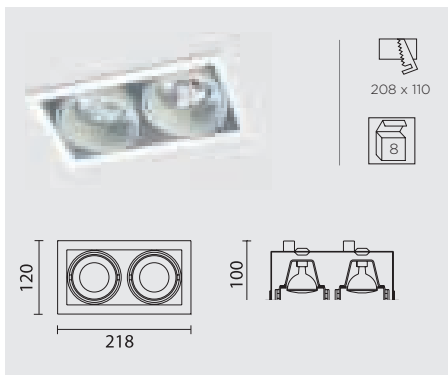

QR-CBC51 / MR16

GU5.3



QR-CBC51 >35W

max. H=55mm

DM-0054-14-00	<input type="checkbox"/>	2 x max. 50W		1-8
DM-0054-N3-00	<input type="checkbox"/>			

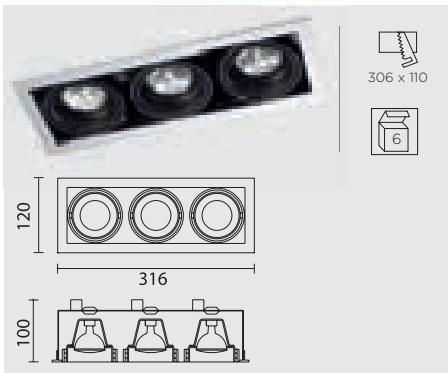

QR-CBC51 / MR16

GU5.3



QR-CBC51 >35W

max. H=55mm

DM-0055-14-00	<input type="checkbox"/>	3 x max. 50W		1-8
DM-0055-N3-00	<input type="checkbox"/>			

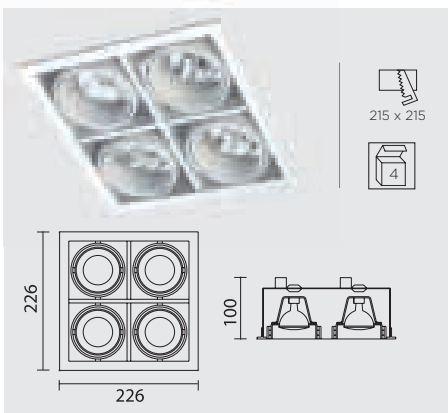

QR-CBC51 / MR16

GU5.3

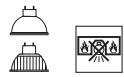

QR-CBC51 >35W

max. H=55mm

DM-0056-14-00	<input type="checkbox"/>	4 x max. 50W		1-8
DM-0056-N3-00	<input type="checkbox"/>			

MULTIDIR TRIMLESS

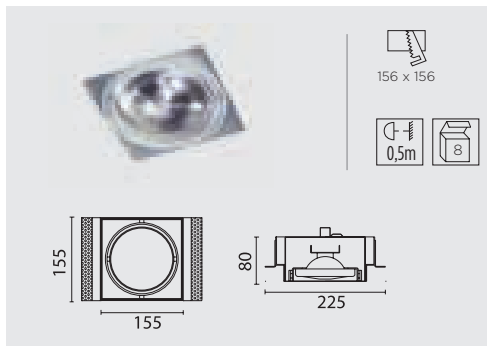
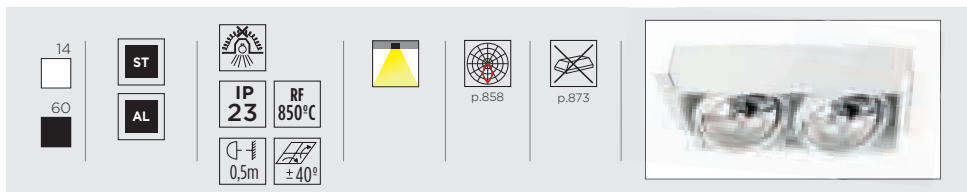

QR-111 / AR-111

G53	DM-0081-14-00	<input type="checkbox"/>	max. 100W			9-14/ 22-25
	DM-0081-60-00	<input checked="" type="checkbox"/>				
	12V		QR-111>65W			

AR-111

GU10	DM-1159-14-00	<input type="checkbox"/>	-	-		22-25
	DM-1159-60-00	<input checked="" type="checkbox"/>				
<input type="checkbox"/>	110V 240V					

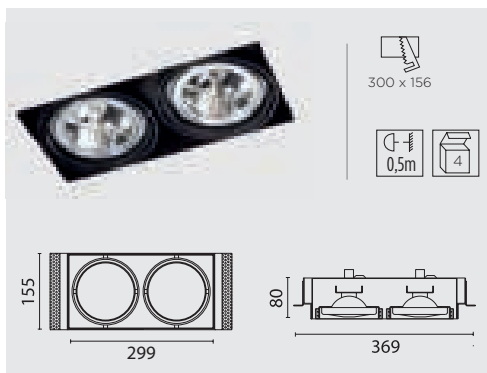

QR-111 / AR-111

G53	DM-0082-14-00	<input type="checkbox"/>	2 x max.100W			9-14/ 22-25
	DM-0082-60-00	<input checked="" type="checkbox"/>				
	12V		QR-111>65W			

AR-111

GU10	DM-1160-14-00	<input type="checkbox"/>	2 x -	-		22-25
	DM-1160-60-00	<input checked="" type="checkbox"/>				
<input type="checkbox"/>	110V 240V					

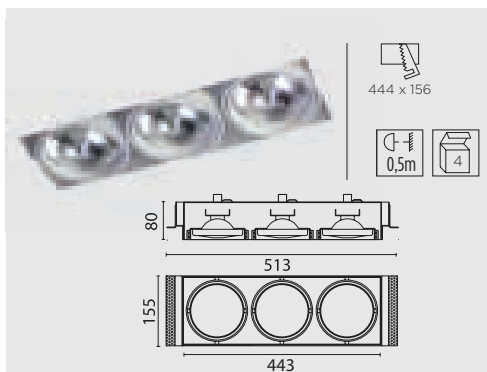

QR-111 / AR-111

G53	DM-0083-14-00	<input type="checkbox"/>	3 x max.100W			9-14/ 22-25
	DM-0083-60-00	<input checked="" type="checkbox"/>				
	12V		QR-111>65W			

AR-111

GU10	DM-1161-14-00	<input type="checkbox"/>	3 x -	-		22-25
	DM-1161-60-00	<input checked="" type="checkbox"/>				
<input type="checkbox"/>	110V 240V					

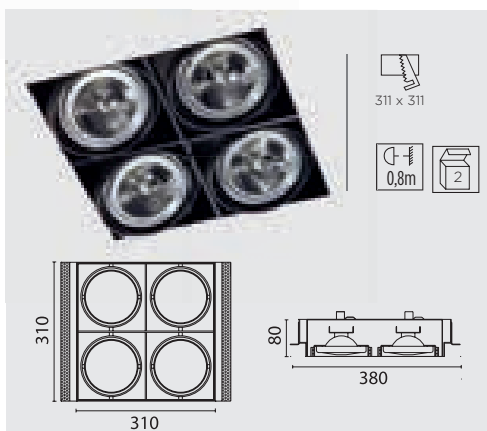

QR-111 / AR-111

G53	DM-0084-14-00	<input type="checkbox"/>	4 x max.100W			9-14/ 22-25
	DM-0084-60-00	<input checked="" type="checkbox"/>				
	12V		QR-111>65W			

AR-111

GU10	DM-1162-14-00	<input type="checkbox"/>	4 x -	-		22-25
	DM-1162-60-00	<input checked="" type="checkbox"/>				
<input type="checkbox"/>	110V 240V					

Accesorios / Accessories / Accessoires / Zubehöre / Accessori / Acessórios / Аксессуары / Akcesoria



ACT-9131-11-00

QR-111



ACT-9131-25-00

QR-111



ACT-9131-08-00

QR-111



ACT-9131-24-00

QR-111



MULTIDIR TRIMLESS

14 	ST							
60 	AL	IP 23	RF 850°C	12V				



108 x 108

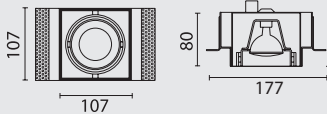

QR-CBC51 / MR16

GU5.3

DM-0093-14-00

max. 50W



DM-0093-60-00



QR-CBC51 >35W

(max. H=55mm)



206 x 108



QR-CBC51 / MR16

GU5.3

DM-0094-14-00

2 x max.
50W



DM-0094-60-00



QR-CBC51 >35W

(max. H=55mm)



304 x 108



QR-CBC51 / MR16

GU5.3

DM-0095-14-00

3 x max.
50W



DM-0095-60-00



QR-CBC51 >35W

(max. H=55mm)



214 x 214

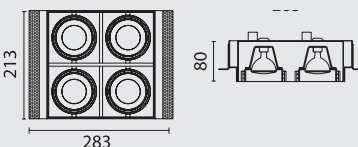

QR-CBC51 / MR16

GU5.3

DM-0096-14-00

4 x max.
50W



DM-0096-60-00



QR-CBC51 >35W

(max. H=55mm)



BACO

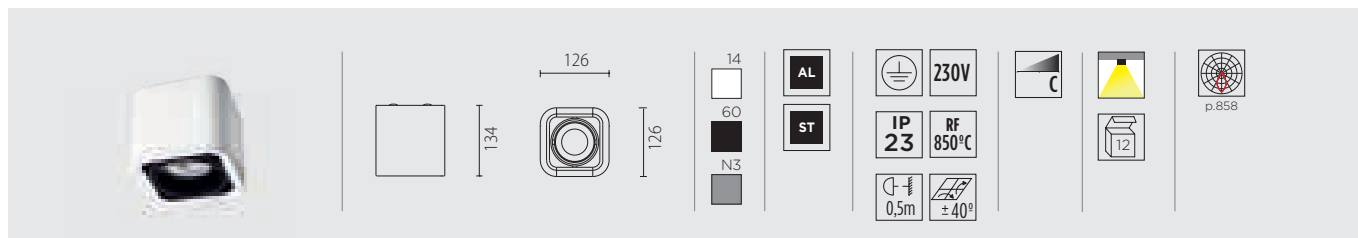

QR-CBC51

GU5.3



DM-1150-14-00	<input type="checkbox"/>	max. 50W	* 1-8
DM-1150-60-00	<input type="checkbox"/>		
DM-1150-N3-00	<input type="checkbox"/>		

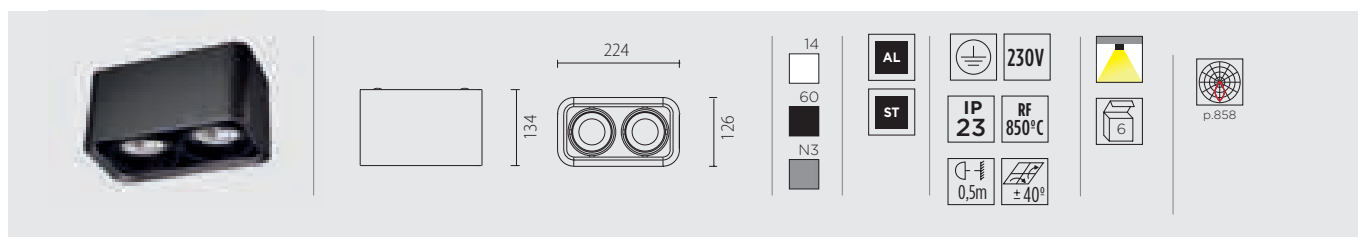

QR-CBC51

GU5.3



DM-1151-14-00	<input type="checkbox"/>	2 x max. 50W	* 1-8
DM-1151-60-00	<input type="checkbox"/>		
DM-1151-N3-00	<input type="checkbox"/>		

MR16

NEW

GU5.3



(max. H=50 mm)

90-3550-14-00	<input type="checkbox"/>	-	
90-3550-60-00	<input type="checkbox"/>		
90-3550-N3-00	<input type="checkbox"/>		

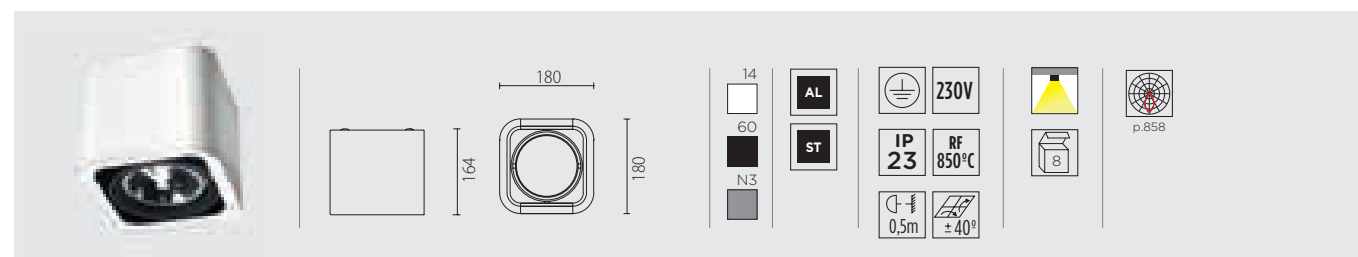

QR-111 **

G53



DM-1100-14-00	<input type="checkbox"/>	max. 75W	* 9-11
DM-1100-60-00	<input type="checkbox"/>		
DM-1100-N3-00	<input type="checkbox"/>		

AR-111

NEW

G53



(max. H=57 mm)

90-3546-14-00	<input type="checkbox"/>	-	 22-25
90-3546-60-00	<input type="checkbox"/>		
90-3546-N3-00	<input type="checkbox"/>		

* Posibilidad de servir estas referencias sin equipo. Consulte a nuestro Equipo Comercial

** Versiones de descarga a consultar / Discharge lamps versions upon request. / Versions à décharge sur demande / Ausführungen mit Entladungslampen auf Anfrage / Versioni su richiesta per lampade scarica / Versões para lâmpada de descarga mediante consulta / O моделях с разрядными лампами спрашивайте дополнительно / Wersje lamp wyładowczych do skonsultowania

BACO

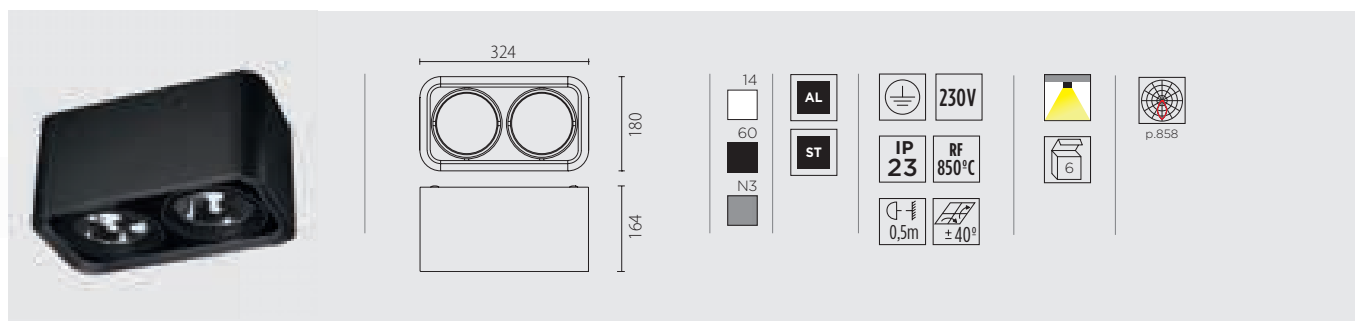

QR-111 **

G53



DM-1101-14-00	<input type="checkbox"/>	2 x max. 75W			9-11
DM-1101-60-00	<input type="checkbox"/>				
DM-1101-N3-00	<input type="checkbox"/>				

AR-111 NEW

G53



(max. H=77 mm)

90-3547-14-00	<input type="checkbox"/>	-			22-25
90-3547-60-00	<input type="checkbox"/>				
90-3547-N3-00	<input type="checkbox"/>				

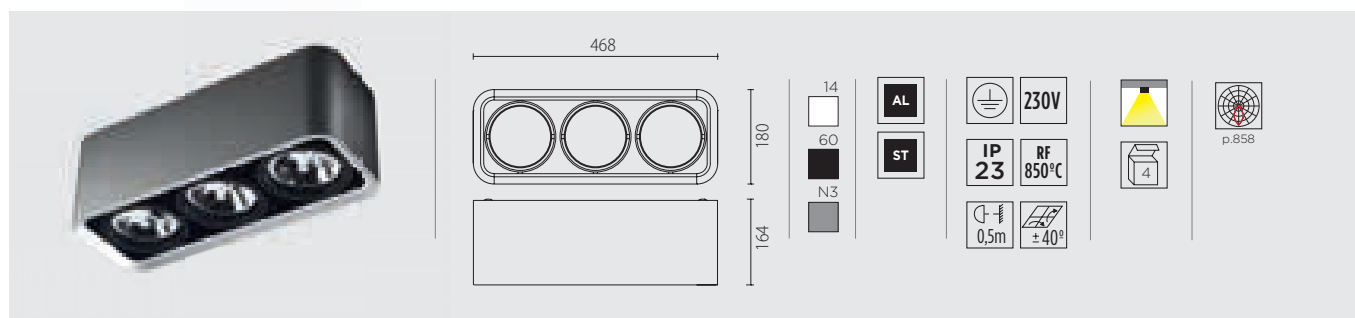

QR-111 **

G53

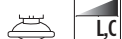

DM-1102-14-00	<input type="checkbox"/>	3 x max. 75W			9-11
DM-1102-60-00	<input type="checkbox"/>				
DM-1102-N3-00	<input type="checkbox"/>				

AR-111 NEW

G53



(max. H=77 mm)

90-3548-14-00	<input type="checkbox"/>	-			22-25
90-3548-60-00	<input type="checkbox"/>				
90-3548-N3-00	<input type="checkbox"/>				

* Posibilidad de servir estas referencias sin equipo. Consulte a nuestro Equipo Comercial

** Versiones de descarga a consultar / Discharge lamps versions upon request. / Versions à décharge sur demande / Ausführungen mit Entladungslampen auf Anfrage / Versioni su richiesta per lampade scarica / Versões para lâmpada de descarga mediante consulta / O моделях с разрядными лампами спрашивайте дополнительно / Wersje lamp wyładowczych do skonsultowania

BACO

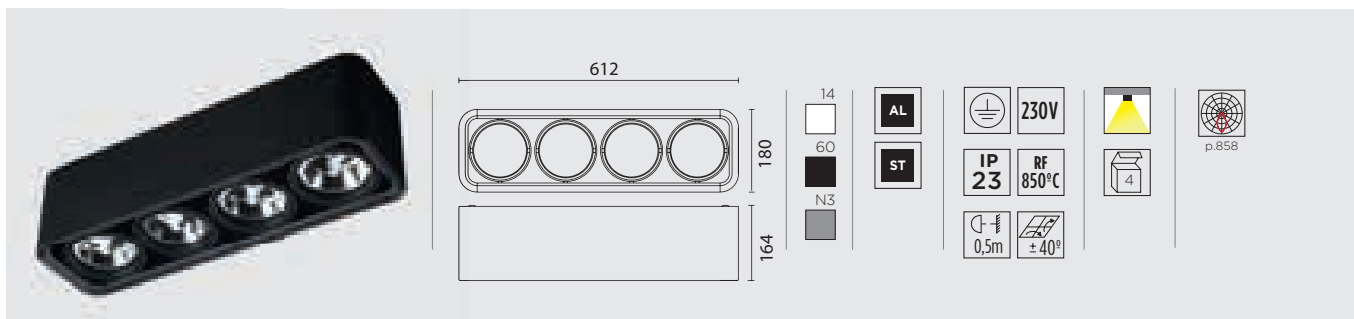

QR-111 **

G53



DM-1103-14-00^(S) <input type="checkbox"/>	4 x max. 75W		*
DM-1103-60-00^(S) <input type="checkbox"/>			
DM-1103-N3-00^(S) <input type="checkbox"/>			

AR-111 NEW

G53



(max. H=77 mm)

90-3549-14-00 <input type="checkbox"/>	-		
90-3549-60-00 <input type="checkbox"/>			
90-3549-N3-00 <input type="checkbox"/>			

Accesorios / Accessories / Accessoires / Zubehöre /
Accessori / Acessórios / Аксессуары / Akcesoria

PARA CÓDIGO / FOR CODE
POUR CODE / FÜR ARTIKEL-NR /
PER CODICE / PARA CÓDIGO /
ДЛЯ АРТИКУЛА / DLA KODU

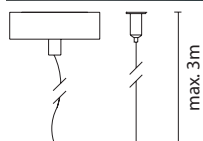

ACT-9044-14-00 <input type="checkbox"/>	DM-1100 90-3546	Kit suspensión + 1 sirga / Suspension Kit + 1 steel cable / Kit suspension + 1 câble de suspension / Aufhängekit + 1 Stahlkabel / Kit sospension + 1 cavo / Kit de suspensão + 1 cabo de suspensão / Набор для подвешенного монтажа + 1 трос / Zestaw do zawieszenia + 1 linka
ACT-9044-60-00 <input type="checkbox"/>		
ACT-9044-N3-00 <input type="checkbox"/>		
ACT-9045-14-00 <input type="checkbox"/>	DM-1101 90-3547 DM-1102 90-3548 DM-1103 90-3549	Kit suspensión + 2 sirga / Suspension Kit + 2 steel cable / Kit suspension + 2 câble de suspension / Aufhängekit + 2 Stahlkabel / Kit sospension + 2 cavi / Kit de suspensão + 2 cabos de suspensão / Набор для подвешенного монтажа + 2 троса / Zestaw do zawieszenia + 2 linka
ACT-9045-60-00 <input type="checkbox"/>		
ACT-9045-N3-00 <input type="checkbox"/>		

	ACT-9131-11-00	QR-111	
	ACT-9131-08-00	QR-111	
	ACT-9131-25-00	QR-111	
	ACT-9131-24-00	QR-111	



* Posibilidad de servir estas referencias sin equipo. Consulte a nuestro Equipo Comercial

** Versiones de descarga a consultar / Discharge lamps versions upon request. / Versions à décharge sur demande / Ausführungen mit Entladungslampen auf Anfrage / Versioni su richiesta per lampade scarica / Versões para lâmpada de descarga mediante consulta / O моделях с разрядными лампами спрашивайте дополнительно / Wersje lamp wyładowczych do skonsultowania



EXIT



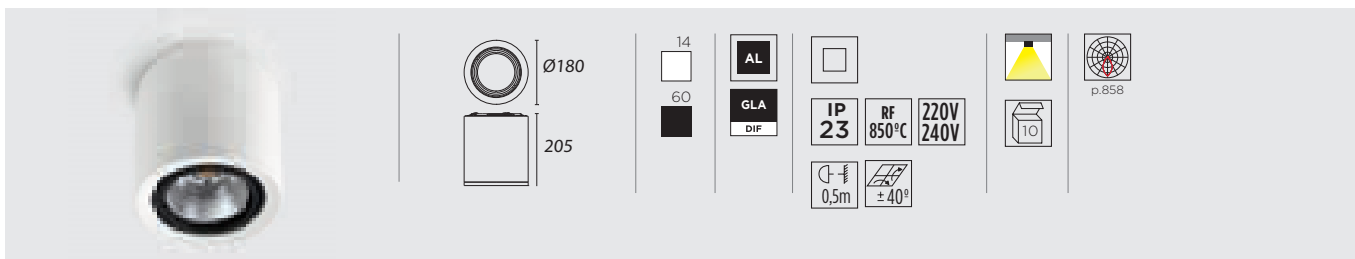

LED



Estándar
Zhaga /
Zhaga
Standard

90-2991-14-37	<input type="checkbox"/>	3000K	CRI>80	12°	26W	
90-2991-60-37	<input checked="" type="checkbox"/>			24°		
90-2992-14-37	<input type="checkbox"/>			38°		
90-2992-60-37	<input checked="" type="checkbox"/>	4000K	CRI>80	12°	24W	
90-2993-14-37	<input type="checkbox"/>			24°		
90-2993-60-37	<input checked="" type="checkbox"/>			38°		
90-2994-14-37	<input type="checkbox"/>	3000K	CRI>90	12°	23W	
90-2994-60-37	<input checked="" type="checkbox"/>			24°		
90-2995-14-37	<input type="checkbox"/>			38°		
90-2995-60-37	<input checked="" type="checkbox"/>	3000K	CRI>80	12°	28W	
90-2996-14-37	<input type="checkbox"/>			24°		
90-2996-60-37	<input checked="" type="checkbox"/>			38°		
90-3523-14-37	<input type="checkbox"/>	3000K	CRI>90	12°	33W	
90-3523-60-37	<input checked="" type="checkbox"/>			24°		
90-3524-14-37	<input type="checkbox"/>			38°		
90-3524-60-37	<input checked="" type="checkbox"/>	3000K	CRI>90	12°	26W	
90-3525-14-37	<input type="checkbox"/>			24°		
90-3525-60-37	<input checked="" type="checkbox"/>			38°		
90-2997-14-37	<input type="checkbox"/>	3000K	CRI>80	12°	26W	
90-2997-60-37	<input checked="" type="checkbox"/>			24°		
90-2998-14-37	<input type="checkbox"/>			38°		
90-2998-60-37	<input checked="" type="checkbox"/>	4000K	CRI>80	12°	26W	
90-2999-14-37	<input type="checkbox"/>			24°		
90-2999-60-37	<input checked="" type="checkbox"/>			38°		
90-3000-14-37	<input type="checkbox"/>	3000K	CRI>90	12°	33W	
90-3000-60-37	<input checked="" type="checkbox"/>			24°		
90-3204-14-37	<input type="checkbox"/>			38°		
90-3204-60-37	<input checked="" type="checkbox"/>	3000K	CRI>90	12°	33W	
90-3207-14-37	<input type="checkbox"/>			24°		
90-3207-60-37	<input checked="" type="checkbox"/>			38°		
90-3526-14-37	<input type="checkbox"/>	3000K	CRI>90	12°	33W	
90-3526-60-37	<input checked="" type="checkbox"/>			24°		
90-3527-14-37	<input type="checkbox"/>			38°		
90-3527-60-37	<input checked="" type="checkbox"/>	3000K	CRI>90	12°	33W	
90-3528-14-37	<input type="checkbox"/>			24°		
90-3528-60-37	<input checked="" type="checkbox"/>			38°		

QR-111

G53

(max. H=77 mm)

90-2984-14-00	<input type="checkbox"/>	max.100W			09-14
90-2984-60-00	<input checked="" type="checkbox"/>				

CDM-R111

GX8,5



90-2982-14-00	<input type="checkbox"/>	35W			15-20
90-2982-60-00	<input checked="" type="checkbox"/>				
90-2983-14-00	<input type="checkbox"/>	70W			15-20
90-2983-60-00	<input checked="" type="checkbox"/>				

AR-111

GU10



(max. H=100 mm)

90-2981-14-00	<input type="checkbox"/>	-	-		22-25
90-2981-60-00	<input checked="" type="checkbox"/>				

EXIT

NEW

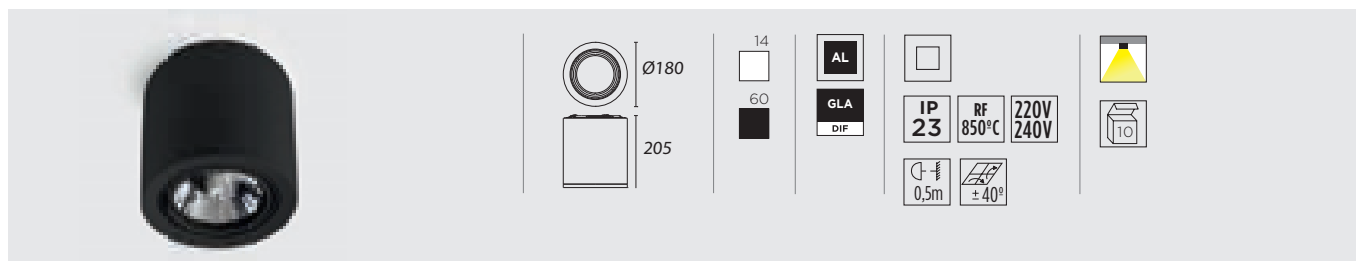

HIT-TC

G8.5



90-2985-14-37	<input type="checkbox"/>	35W		10°
90-2985-60-37	<input checked="" type="checkbox"/>			24°
90-2986-14-37	<input type="checkbox"/>			45°
90-2986-60-37	<input checked="" type="checkbox"/>			10°
90-2987-14-37	<input type="checkbox"/>	70W		24°
90-2987-60-37	<input checked="" type="checkbox"/>			45°
90-2988-14-37	<input type="checkbox"/>			10°
90-2988-60-37	<input checked="" type="checkbox"/>			24°
90-2989-14-37	<input type="checkbox"/>	70W		45°
90-2989-60-37	<input checked="" type="checkbox"/>			10°
90-2990-14-37	<input type="checkbox"/>			24°
90-2990-60-37	<input checked="" type="checkbox"/>			45°

EXIT

NEW

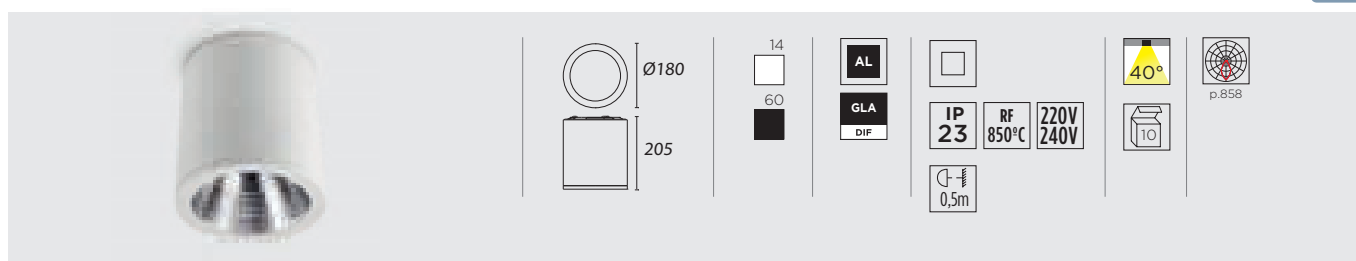

LED

 Estándar
Zhaga /
Zhaga
Standard

90-3208-14-37	<input type="checkbox"/>	2000 lm ⁽ⁿ⁾	CRI>80	3000K	26W	
90-3208-60-37	<input checked="" type="checkbox"/>			4000K	24W	
90-3209-14-37	<input type="checkbox"/>			3000K	23W	
90-3209-60-37	<input checked="" type="checkbox"/>			3000K	28W	
90-3210-14-37	<input type="checkbox"/>	3000 lm ⁽ⁿ⁾	CRI>80	4000K	26W	
90-3210-60-37	<input checked="" type="checkbox"/>			3000K	33W	
90-3211-14-37	<input type="checkbox"/>			3000K	26W	
90-3211-60-37	<input checked="" type="checkbox"/>			4000K	33W	
90-3530-14-37	<input type="checkbox"/>			3000K	26W	
90-3530-60-37	<input checked="" type="checkbox"/>			3000K	33W	

Accesorios / Accessories / Accessoires / Zubehöre / Accessori / Acessórios / Аксессуары / Akcesoria

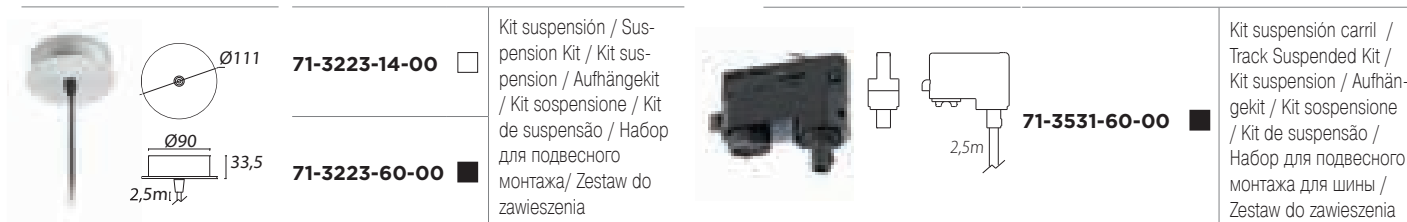



ROUND FIT



LED



15-4725-N3-M1	■	Warm W 3000K	max. 14W		Standard
15-4726-N3-M1	■	Neutral W 4000K			
15-2464-N3-M1	■	Warm W 3000K		Emergency 3h	
15-2465-N3-M1	■	Neutral W 4000K			

15-4725 LED Blanco cálido / Warm white 1050mA

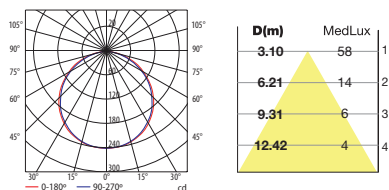



EQUAL SPOT

NEW

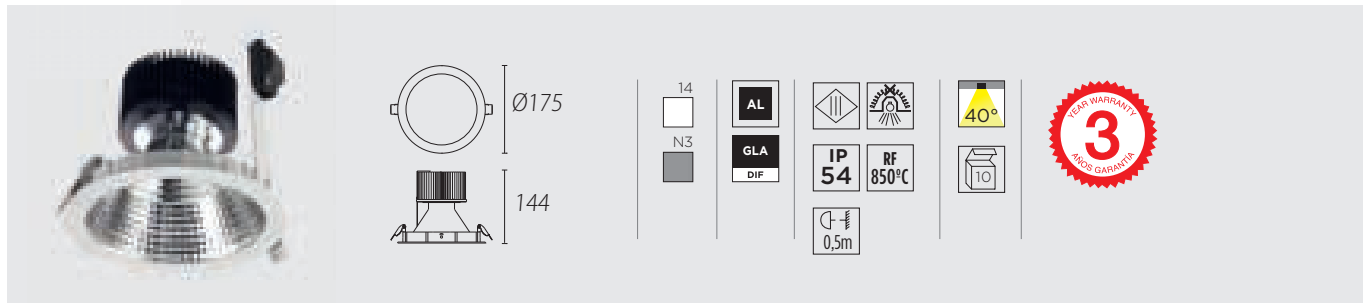

LED

Estándar
Zhaga /
Zhaga
Standard

90-2977-14-37 <input type="checkbox"/>	2000 lm ^(N)	3000K	CRI>80	26W	
90-2977-N3-37 <input type="checkbox"/>		4000K		24W	
90-2978-14-37 <input type="checkbox"/>		3000K	CRI>90	23W	
90-2978-N3-37 <input type="checkbox"/>					
90-3521-14-37 <input type="checkbox"/>	3000 lm ^(N)	3000K	CRI>80	28W	
90-3521-N3-37 <input type="checkbox"/>				4000K	
90-2979-14-37 <input type="checkbox"/>		3000K	CRI>90		
90-2979-N3-37 <input type="checkbox"/>					
90-2980-14-37 <input type="checkbox"/>					
90-2980-N3-37 <input type="checkbox"/>					
90-3522-14-37 <input type="checkbox"/>	3000K	CRI>90	33W		
90-3522-N3-37 <input type="checkbox"/>					



Equipos / Gears / Dispositifs / Treiber / Driver / Equipamentos / Устройства / Osprzęt

	71-2476-00-00	1 driver = 1 Equal Spot	Driver ON / OFF 220-240 VAC	32 x 46 x 190 mm
--	----------------------	-----------------------------------	--------------------------------	------------------

LED Zhaga 4500lm^(R), consulte con Equipo Comercial.
 LED Zhaga 4500lm^(R), speak to the Sales Team.
 LED Zhaga 4500lm^(R), adressez-vous à l'équipe commerciale.
 LED Zhaga 4500lm^(R), wenden Sie sich bitte an unseren Vertrieb.
 LED Zhaga 4500lm^(R), consultare il Team di Vendita.
 LED Zhaga 4500lm^(R), consulte a Equipa de Vendas.
 LED Zhaga 4500lm^(R), обращайтесь к нашим менеджерам
 LED Zhaga 4500lm^(R), proszę skonsultować się z działem handlowym.



EQUAL S

Ø172
175 x 175
114
160 x 160

14
N3
AL
PMMA
DIF
IP 54
0.2m
CREE Led
80°
1825 lm⁽⁹⁾
2636 lm⁽⁹⁾
W WHITE
W WHITE
12 Led
18 Led
η HIGH >90%
3 YEAR WARRANTY
3 YEARS WARRANTY



LED

	Ø172	90-0713-14-M3	<input type="checkbox"/>	Warm W 3000K	max. 2000mA	12 Led	max. 27W	
		90-0713-N3-M3	<input type="checkbox"/>					

**equivalente a
as bright as**
 2 x 18W CFL

LED

	Ø172	90-0714-14-M3	<input type="checkbox"/>	Warm W 3000K	max. 1900mA	18 Led	max. 39W	
		90-0714-N3-M3	<input type="checkbox"/>					

**equivalente a
as bright as**
 2 x 26W CFL



LED

	175 x 175	90-0723-14-M3	<input type="checkbox"/>	Warm W 3000K	max. 2000mA	12 Led	max. 27W	
		90-0723-N3-M3	<input type="checkbox"/>					

**equivalente a
as bright as**
 2 x 18W CFL

LED

	175 x 175	90-0724-14-M3	<input type="checkbox"/>	Warm W 3000K	max. 1900mA	18 Led	max. 39W	
		90-0724-N3-M3	<input type="checkbox"/>					

**equivalente a
as bright as**
 2 x 26W CFL

Max. 27W Blanco cálido / Warm white

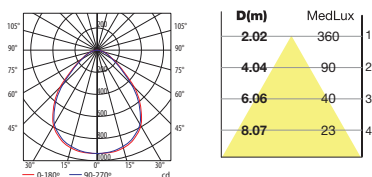

Max. 39W Blanco cálido / Warm white 1900mA

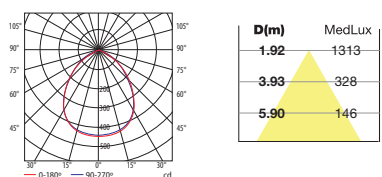

EQUAL L

250
 250 x 250
 139
 115
 240 x 240

14
 N3

AL
 PMMA
 DIF

IP 54
 0.2m

CREE Led

83°
 4

1760 lm^(R)
 W WHITE
 12 Led

2435 lm^(R)
 W WHITE
 18 Led

η
 HIGH >90%

3 YEAR WARRANTY
 3
 3000 GARANTIA



LED



Ø250

90-0861-14-M3

90-0861-N3-M3

Warm W
3000K

max.
2000mA

12
Led

max.
27W



equivalente a
as bright as
2 x 18W CFL

LED



Ø250

90-0931-14-M3

90-0931-N3-M3

Warm W
3000K

max.
1900mA

18
Led

max.
39W



equivalente a
as bright as
2 x 26W CFL



LED



250 x 250

90-0907-14-M3

90-0907-N3-M3

Warm W
3000K

max.
2000mA

12
Led

max.
27W



equivalente a
as bright as
2 x 18W CFL

LED



250 x 250

90-0908-14-M3

90-0908-N3-M3

Warm W
3000K

max.
1900mA

18
Led

max.
39W



equivalente a
as bright as
2 x 26W CFL

Max. 27W Blanco cálido / Warm white 2000mA

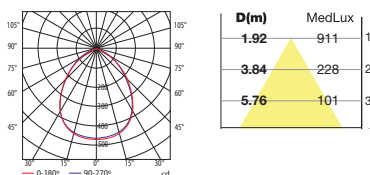

Max. 39W Blanco cálido / Warm white 1900mA

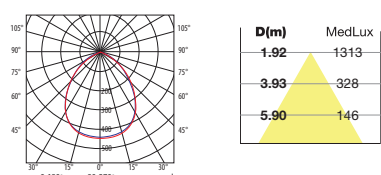

EQUAL S

14
 N3
 AL
 PMMA
 DIF
 IP 54
 0,2m
 80°
 1877 lm^(R) N WHITE 18W
 2711 lm^(R) N WHITE 26W
 HIGH >90%
 Estándar Zhaga Zhaga Standard
 3 YEAR WARRANTY / 3 ANOS GARANTIA



LED

 	Ø172	90-2023-14-M3	<input type="checkbox"/>	Neutral W 4000K	18W	
		90-2023-N3-M3	<input type="checkbox"/>			

**equivalente a
as bright as**
2x 18W CFL

LED

 	Ø172	90-2025-14-M3	<input type="checkbox"/>	Neutral W 4000K	26W	
		90-2025-N3-M3	<input type="checkbox"/>			

**equivalente a
as bright as**
2x 26W CFL



LED

 	175 x 175	90-2027-14-M3	<input type="checkbox"/>	Neutral W 4000K	18W	
		90-2027-N3-M3	<input type="checkbox"/>			

**equivalente a
as bright as**
2x 18W CFL

LED

 	175 x 175	90-2029-14-M3	<input type="checkbox"/>	Neutral W 4000K	26W	
		90-2029-N3-M3	<input type="checkbox"/>			

**equivalente a
as bright as**
2x 26W CFL

LED 18W Blanco neutro / Neutral white

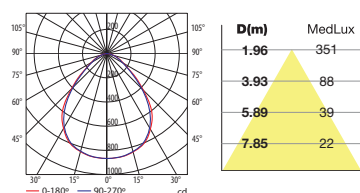

LED 26W Blanco neutro / Neutral white

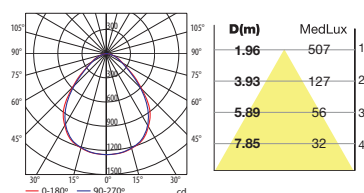

LED Zhaga 4500lm^(R), consulte con Equipo Comercial.
 LED Zhaga 4500lm^(R), speak to the Sales Team.
 LED Zhaga 4500lm^(R), adressez-vous à l'équipe commerciale.
 LED Zhaga 4500lm^(R), wenden Sie sich bitte an unseren Vertrieb.
 LED Zhaga 4500lm^(R), consultare lo staff commerciale
 LED Zhaga 4500lm^(R), consulte a Equipa de Vendas.
 LED Zhaga 4500lm^(R), обращайтесь к нашим менеджерам
 LED Zhaga 4500lm^(R), proszę skontaktować się z działem handlowym.

Equipos / Gears / Dispositifs / Treiber / Driver / Equipamentos / Устройства / Osprzęt



71-2476-00-00	1 driver = 1 Equal	Driver ON / OFF 220-240 VAC	32 x 46 x 190 mm
----------------------	-----------------------	--------------------------------	------------------

EQUAL L

14

N3

AL

PMMA

DIF

IP

54

0,2m

83°

4

2000 lm^(R)

2700 lm^(R)

N

N

WHITE

WHITE

18W

26W

η

HIGH >90%

Estándar Zhaga
Zhaga Standard

3 YEAR WARRANTY
3 YEAR WARRANTY



LED

	Ø250	90-2064-14-M3	<input type="checkbox"/>	Neutral W 4000K	18W	
		90-2064-N3-M3	<input type="checkbox"/>			

equivalente a
as bright as
2 x 18W CFL

LED

	Ø250	90-2069-14-M3	<input type="checkbox"/>	Neutral W 4000K	26W	
		90-2069-N3-M3	<input type="checkbox"/>			

equivalente a
as bright as
2 x 26W CFL



LED

	250 x 250	90-2073-14-M3	<input type="checkbox"/>	Neutral W 4000K	18W	
		90-2073-N3-M3	<input type="checkbox"/>			

equivalente a
as bright as
2 x 18W CFL

LED

	250 x 250	90-2077-14-M3	<input type="checkbox"/>	Neutral W 4000K	26W	
		90-2077-N3-M3	<input type="checkbox"/>			

equivalente a
as bright as
2 x 26W CFL

LED 18W Blanco neutro / Neutral white

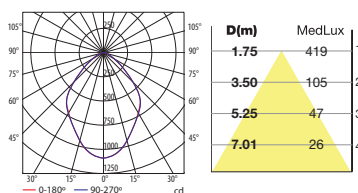

LED 26W Blanco neutro / Neutral white

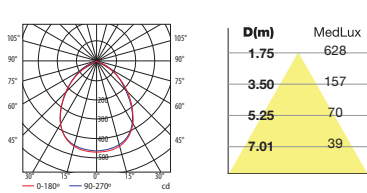

LED Zhaga 4500lm^(R), consulte con Equipo Comercial.
 LED Zhaga 4500lm^(R), speak to the Sales Team.
 LED Zhaga 4500lm^(R), adressez-vous à l'équipe commerciale.
 LED Zhaga 4500lm^(R), wenden Sie sich bitte an unseren Vertrieber.
 LED Zhaga 4500lm^(R), consultare lo staff commerciale
 LED Zhaga 4500lm^(R), consulte a Equipa de Vendas.
 LED Zhaga 4500lm^(R), обращайтесь к нашим менеджерам
 LED Zhaga 4500lm^(R), proszę skonsultować się z działem handlowym.



Equipos / Gears / Dispositifs / Treiber / Driver / Equipamentos / Устройства / Osprzęt			
71-2476-00-00	1 driver = 1 Equal	Driver ON / OFF 220-240 VAC	32 x 46 x 190 mm

ROL





ARENADO / SANDBLASTED / SABLÉ / SANDGESTRAHLT / SABBIATO / AREADO / МАТОВОЕ / PIASKOWANY

SEMI ARENADO / SEMI-SANDBLASTED / DEMI SABLÉ / HALBSANDGESTRAHLT / SEMI-SABBIATO / SEMI-AREADO / ПОЛУМАТОВОЕ РОЛ-PIASKOWANY

SERIGRAFIADO / SILKSCREENED / SÉRIGRAPHIÉ / SIEBDRUCK / SERIGRAFATO / SERIGRAFADO / С ТРАФАРЕТНОЙ ПЕЧАТЬЮ / Z SITODRUKIEM



ROL



TC-DEL

G24q-2



DN-1680-14-00	<input type="checkbox"/>	2x18W	*
----------------------	--------------------------	-------	---

TC-DEL G24q-2 2 x 18W

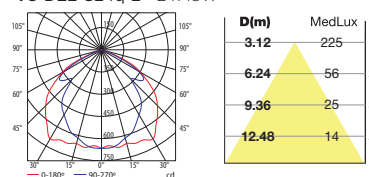

η=72%

TC-DEL

G24q-3



90-2502-14-00	<input type="checkbox"/>	2x26W	*
----------------------	--------------------------	-------	---

TC-DEL G24q-3 2 x 26W

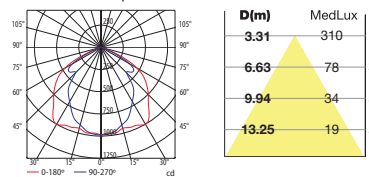

η=68%

Para versiones con una lámpara y/o versiones con portalámparas E-27, consulte con Equipo Comercial.
 For versions with one lamp and/or versions with an E-27 light bulb socket, please contact your sales representative.
 Pour les versions à une lampe et/ou les versions à douille E-27, adressez-vous à l'équipe commerciale.
 Für Ausführungen mit einem Leuchtmittel und/oder Ausführungen mit Lampenfassung E-27 wenden Sie sich bitte an unseren Vertrieb.
 Per versioni con una lampada e/o versioni con portalampada E-27, consultare lo staff commerciale.
 Para versões com uma lâmpada e/ou versões com suporte de casquilho E-27, consulte a Equipa de Vendas.
 Для опции с одной лампой и/или с патроном E-27 обращайтесь к нашим менеджерам
 Dla wersji o jednej lampie i/lub wersji z oprawkami E-27, proszę skonsultować się z działem handlowym.

* Posibilidad de servir estas referencias sin equipo. Consulte a nuestro Equipo Comercial

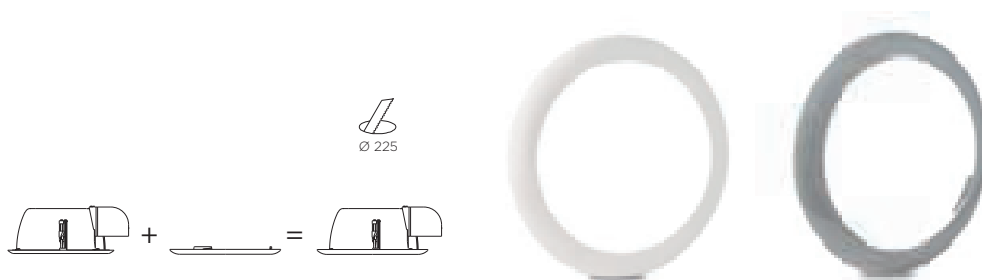

Arenado / Sandblasted / Sablé / Sandgestrahlt / Sabbiato / Areado / Матовое / Piaskowany		ACT-9171-14-T2	ACT-9171-N3-T2
Semiarenado / Semi-sandblasted / Demi sablé/ Halbsandgestrahlt / Semi-sabbiato / Semiareado / Полуматовое / Częściowo piaskowany		ACT-9172-14-T2	ACT-9172-N3-T2
Serigrafiado / Silkscreened / Sérigraphié/ Siebdruck / Serigrafato / Serigrafado / С трафаретной печатью / Z sitodrukiem		ACT-9173-14-H6	ACT-9173-N3-H6



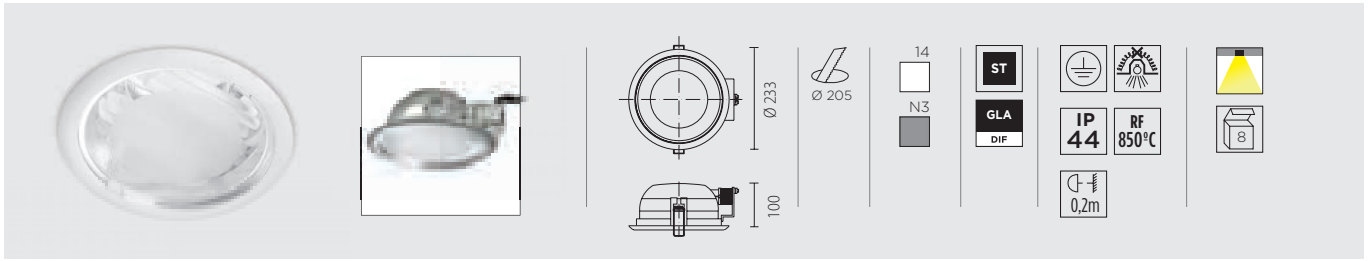

TC-D

G24d-2



DN-1400-14-00	<input type="checkbox"/>	18W	*	Standard
DN-1400-N3-00	<input type="checkbox"/>			
DN-1401-14-00	<input type="checkbox"/>	2x18W		
DN-1401-N3-00	<input type="checkbox"/>			

TC-D G24d-2 2x18W opal

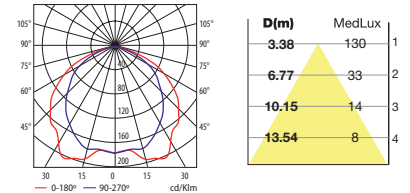

$\eta=55\%$

TC-D

G24d-3



DN-1402-14-00	<input type="checkbox"/>	26W	*	Standard
DN-1402-N3-00	<input type="checkbox"/>			
DN-1403-14-00	<input type="checkbox"/>	2x26W		
DN-1403-N3-00	<input type="checkbox"/>			

TC-D G24d-3 2x26W

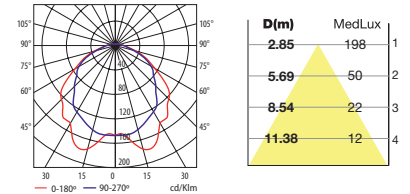

$\eta=47\%$

TC-DEL

G24q-2



DN-1405-14-00	<input type="checkbox"/>	18W	*	Standard
DN-1405-N3-00	<input type="checkbox"/>			
DN-1406-14-00	<input type="checkbox"/>	2x18W	Emergency 3/1h	
DN-1406-N3-00	<input type="checkbox"/>			
DN-1409-14-00	<input type="checkbox"/>			
DN-1409-N3-00	<input type="checkbox"/>			

TC-DEL G24q-2 2x18W opal

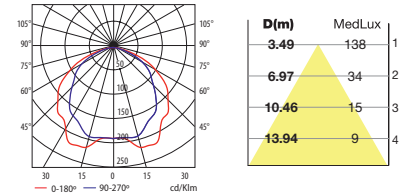

$\eta=61\%$

TC-DEL

G24q-3



DN-1407-14-00	<input type="checkbox"/>	1x26W	*	Standard
DN-1407-N3-00	<input type="checkbox"/>			
DN-1408-14-00	<input type="checkbox"/>	2x26W	Emergency 3/1h	
DN-1408-N3-00	<input type="checkbox"/>			
DN-1410-14-00	<input type="checkbox"/>			
DN-1410-N3-00	<input type="checkbox"/>			

TC-DEL G24q-3 2x26W

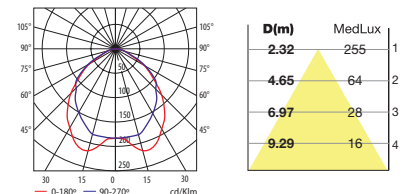

$\eta=53\%$

* Posibilidad de servir estas referencias sin equipo. Consulte a nuestro Equipo Comercial

ECOLED



Technical specifications for ECOLED 90-1783-14-M3:

- Material: AL, PMMA, DIF
- IP: 44
- Beam angle: 90°
- Power: 11W
- Light output: 930 lm^(R)
- Color: W WHITE
- Warranty: 3 YEARS WARRANTY
- Dimensions: Ø130, Ø120, 70mm height
- Mounting: 14mm depth
- Standards: REFOND Led, E 100-240 VAC, 6

LED



90-1783-14-M3	<input type="checkbox"/>	Warm W 3000K	11W
----------------------	--------------------------	-----------------	-----

LED Blanco cálido / Warm white

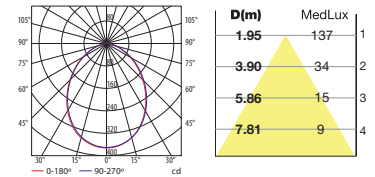

Technical specifications for LED 90-1784-14-M3 and 90-1785-14-M3:

- Material: AL, PMMA, DIF
- IP: 44
- Beam angle: 90°
- Power: 20W and 31W
- Light output: 1620 lm^(R) and 2550 lm^(R)
- Color: W WHITE
- Warranty: 3 YEARS WARRANTY
- Dimensions: Ø230, Ø220, 85mm height
- Mounting: 14mm depth
- Standards: REFOND Led, E 100-240 VAC, 4

LED



90-1784-14-M3	<input type="checkbox"/>	Warm W 3000K	20W
90-1785-14-M3	<input type="checkbox"/>		31W

LED Blanco cálido / Warm white

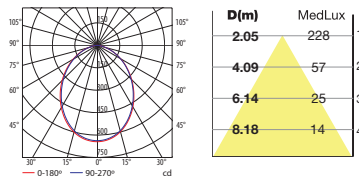

LED Blanco cálido / Warm white

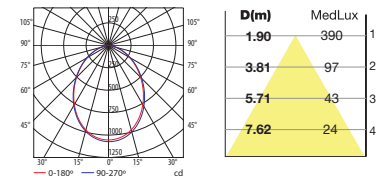

DOWN

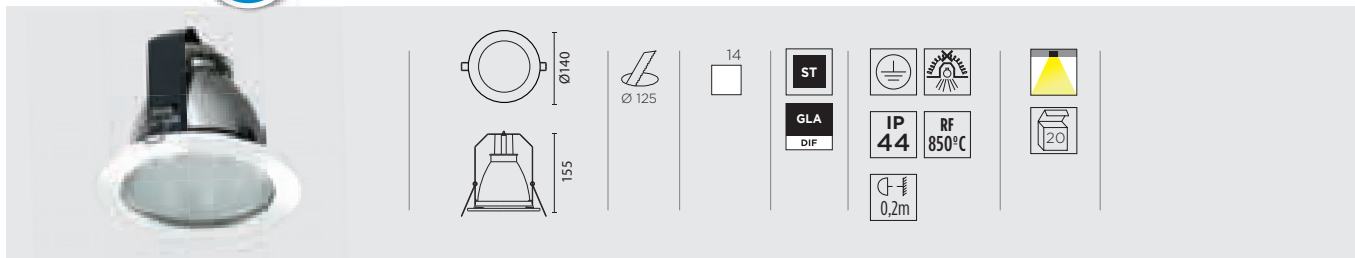

E-27

(max. H=125 mm)

90-1453-14-T2

1 x E-27 PL Elec. Max. 15W
1 x E-27 Max. 100W

E27 15W

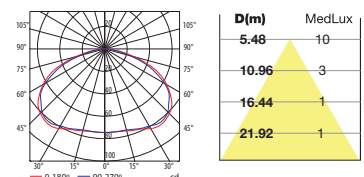

$\eta=46\%$

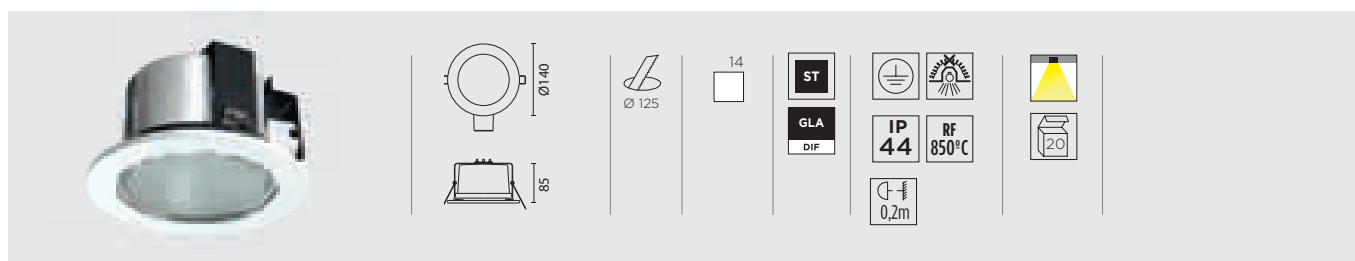

E-27

(max. H=120 mm)

90-1454-14-T2

1 x E-27 PL Elec. Max. 13W
1 x E-27 Max. 60W

E27 13W

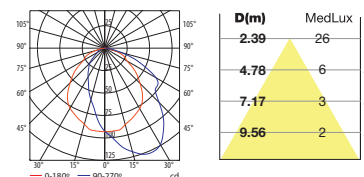

$\eta=38\%$

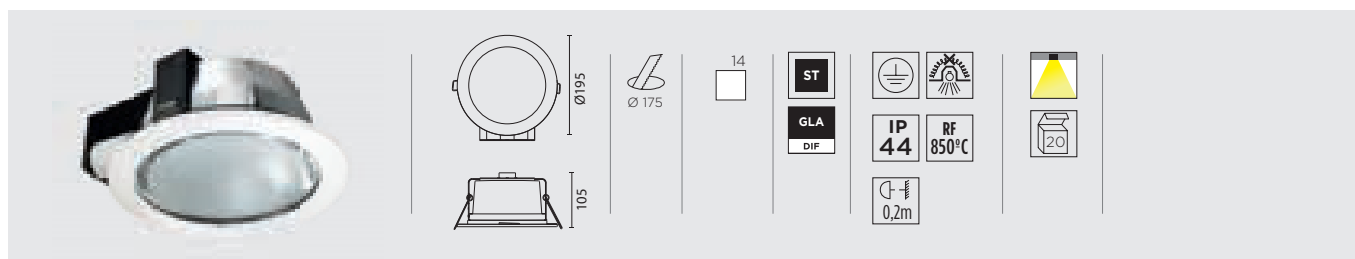

E-27

(max. H=150 mm)

90-1480-14-T2

2 x E-27 PL Elec. Max. 16W
2 x E-27 Max. 60W

E27 16W

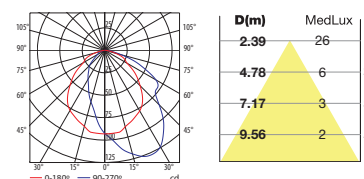

VOL



NEW

Technical specifications for the VOL light fixture:

- Material: AL, PMMA, DIF
- IP Rating: IP 44
- Beam Angle: 73°
- Power: 17,5W
- Voltage: 100-240 VAC
- Light Output: 1098 lm⁹⁰
- Color: W WHITE
- Warranty: 3 YEARS WARRANTY / 3 YEARS WARRANTY
- Dimensions: Ø 180, 14, 56,5
- Mounting: 0-25mm
- Brand: SAMSUNG Led

LED



90-2899-14-M3



Warm W 3000K

17,5W



LED Blanco cálido / Warm white

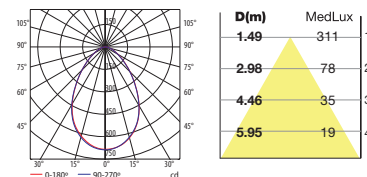



FIT



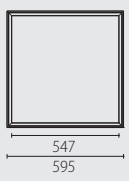

54
N3

547
595

±12,8

AL ANOD
IP 40

PMMA DIF
REFOND Led

max. 1050mA
Dimming

600 Led
120°

3930 lm^(R)
3526 lm^(R)

N WHITE
W WHITE









3
ANOS GARANTÍA

equivalente a
as bright as
3 x T5 (14W)
4 x T8 (18W)

* Sólo para montaje empotrado / Only for recessed mounting

LED

	15-4721-54-M1		Warm W 3000K	max. 40W		Standard
	15-4722-54-M1		Neutral W 4000K			
	15-2456-54-M1*		Warm W 3000K			
	15-2459-54-M1*		Neutral W 4000K			
						Emergency 3h

15-4721-54-M1 LED
Blanco cálido / Warm white

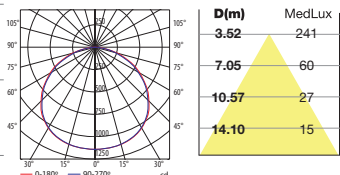



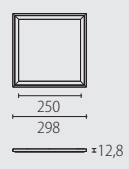

54
N3

250
298

±12,8

AL ANOD
IP 40

PMMA DIF
REFOND Led

max. 500mA
Dimming

300 Led
114°

1500 lm^(R)
968 lm^(R)







N WHITE
W WHITE



3
ANOS GARANTÍA

* Sólo para montaje empotrado / Only for recessed mounting

LED

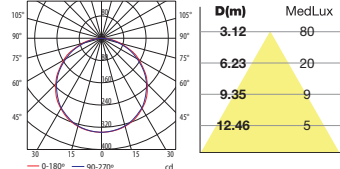

	15-4723-54-M1		Warm W 3000K	max. 18,5W		Standard
	15-4724-54-M1		Neutral W 4000K			
	15-2462-54-M1*		Warm W 3000K			
	15-2463-54-M1*		Neutral W 4000K			
						Emergency 3h

15-4724-54-M1 LED
Blanco neutro / Neutral white





Accesorios / Accessories / Accessoires / Zubehöre / Accessori / Acessórios / Аксессуары / Akcesoria

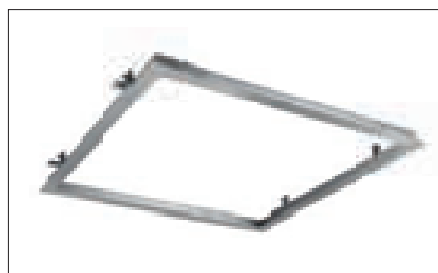

71-4722-N3-00		60X60	Kit de superficie plafón / Surface kit ceiling light / Kit surface Plafonnier / Kit für Aufbau montage /
71-4724-N3-00		30X30	Kit per montaggio a plafoniera / Kit para instalação em superfície / Набор аксессуаров для поверхностного монтажа / Zestaw dla instalacji na powierzchni /



71-0558-54-00		60X60	Kit empotrar plafón / Recessed kit ceiling light / Kit d'encastrement plafonnier / Kit für Einbaumontage / Kit per incasso /
71-0537-54-00		30X30	Kit para instalação encastrada / Набор аксессуаров для встроенного монтажа / Zestaw dla instalacji wbudowanej /
			No necesario en techos tipo Armstrong / Not required in Armstrong ceiling units



71-4723-N3-00		60X60	Kit suspensión plafón / Suspension kit ceiling light / Kit de suspension plafonnier / Aufhängungskit / Kit per sospensione / Kit para instalação suspensa / Набор аксессуаров для подвешенного монтажа / Zestaw dla instalacji zawieszanej /
----------------------	---	-------	---

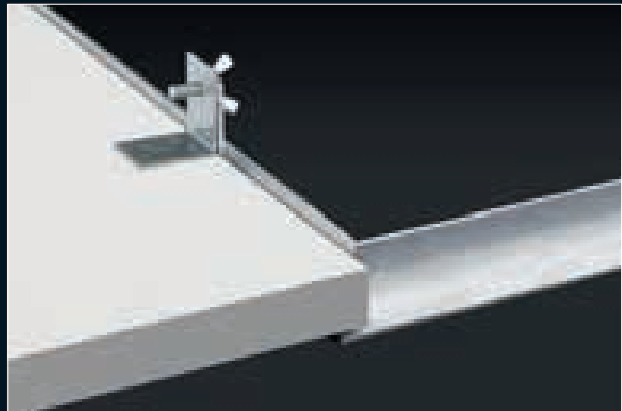

ECOFIT



NEW



52
N3

AL ANOD
PMMA
DIF

IP 40

420 Led
REFOND Led

100-240 VAC

120°

3144 lm^(R) 2935 lm^(R)
N WHITE W WHITE

equivalente a as bright as
3 x T5 (14W)
4 x T8 (18W)

3 YEARS WARRANTY
3 ANOS GARANTIA

547
595
≈12,8

LED

	15-2921-52-M1		Warm W 3000K	40W		ON-OFF
	15-2920-52-M1		Neutral W 4000K			

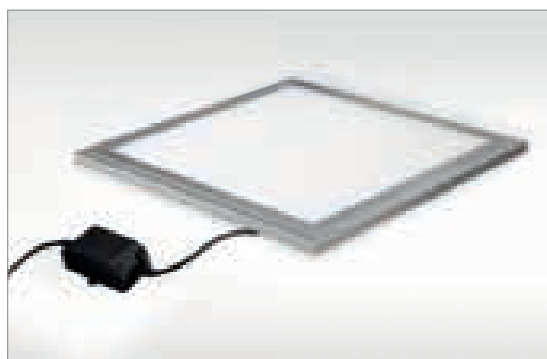

15-2921-52-M1 LED
Blanco cálido / Warm white

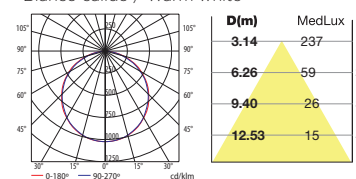

15-2920-52-M1 LED
Blanco neutro / Neutral white

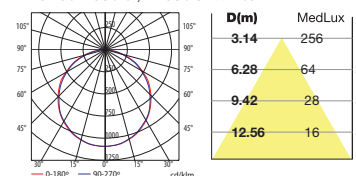

Accesorios / Accessories / Accessoires / Zubehöre / Accessori / Acessórios / Аксессуары / Akcesoria



71-4722-N3-00		60X60	Kit de superficie plafón / Surface kit ceiling light / Kit surface Plafonnier / Kit für Aufbaumontage / Kit per montaggio a plafoniera / Kit para instalação em superfície / Набор аксессуаров для поверхностного монтажа / Zestaw dla instalacji na powierzchni /
----------------------	--	-------	---



71-0558-54-00		60X60 630 x 630	Kit empotrar plafón / Recessed kit ceiling light / Kit d'encastrement plafonnier / Kit für Einbaumontage / Kit per incasso / Kit para instalação encastrada / Набор аксессуаров для встроенного монтажа / Zestaw dla instalacji wbudowanej / No necesario en techos tipo Armstrong / Not required in Armstrong ceiling units
----------------------	--	------------------------	---



71-4723-N3-00		60X60	Kit suspensión plafón / Suspension kit ceiling light / Kit de suspension plafonnier / Aufhängungskit / Kit per sospensione / Kit para instalação suspenso / Набор аксессуаров для подвешенного монтажа / Zestaw dla instalacji zawieszonej /
----------------------	--	-------	---

FRAME / MINI FRAME





ARENADO / SANDBLASTED / SABLÉ /
SANDGESTRAHLT / SABBATO / AREA-
DO / МАТОВОЕ / PIASKOWANY

SEMI ARENADO / SEMI-SANDBLASTED /
DEMI SABLÉ / HALBSANDGESTRAHLT / SEMI-
SABBATO / SEMI-AREADO / ПОЛУМАТОВОЕ
PÓŁ-PIASKOWANY

SERIGRAFIADO / SILKSCREENED /
SÉRIGRAPHIÉ / SIEBDRUCK / SERIGRA-
FATO / SERIGRAFADO / С ТРАФАРЕТНОЙ
ПЕЧАТЬЮ / Z SITODRUKIEM

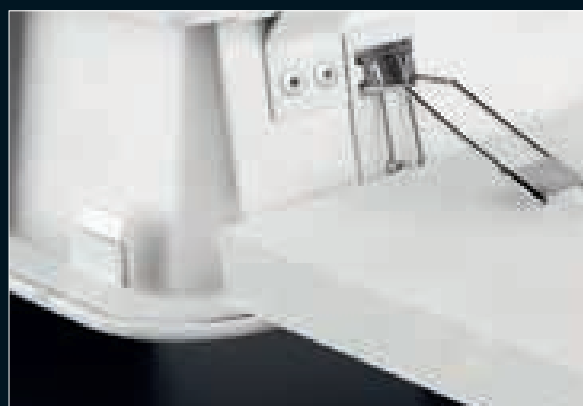

FRAME



 115 212	 212 220 x 220	200 x 200 220 x 220	14 N3	PC GLA DIF	 IP 23 RF 850°C 220V 240V 0,2m	 	 HIGH >70% 
---	---	------------------------	----------	------------------	--	--	---



TC-DEL

G24q-2



DN-1620-14-00			2x18W	 *
----------------------	--	--	-------	--

TC-DEL G24q-2 2X18W

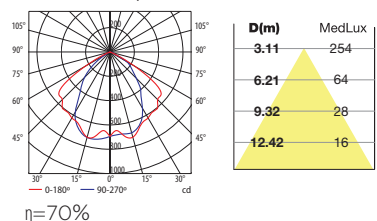

TC-DEL

G24q-3



90-2501-14-00			2x26W	 *
----------------------	---	---	-------	---

TC-DEL G24q-3 2X26W

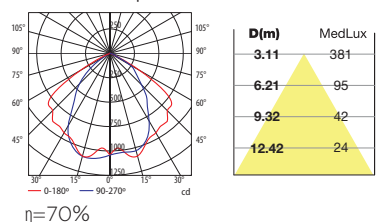

Para versiones con una lámpara y/o versiones con portalámparas E-27, consulte con Equipo Comercial.
 For versions with one lamp and/or versions with an E-27 light bulb socket, please contact your sales representative.
 Pour les versions à une lampe et/ou les versions à douille E-27, adressez-vous à l'équipe commerciale.
 Für Ausführungen mit einem Leuchtmittel und/oder Ausführungen mit Lampenfassung E-27 wenden Sie sich bitte an unseren Vertrieb.
 Per versioni con una lampada e/o versioni con portalampe E-27, consultare lo staff commerciale.
 Para versões com uma lâmpada e/ou versões com suporte de casquilho E-27, consulte a Equipa de Vendas.
 Для опции с одной лампой и/или с патроном E-27 обращайтесь к нашим менеджерам
 Dla wersji o jednej lampie i/lub wersji z oprawkami E-27, proszę skonsultować się z działem handlowym.



* Posibilidad de servir estas referencias sin equipo. Consulte a nuestro Equipo Comercial

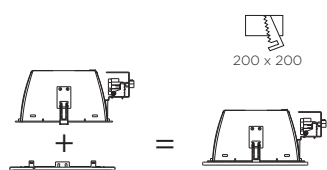

200 x 200

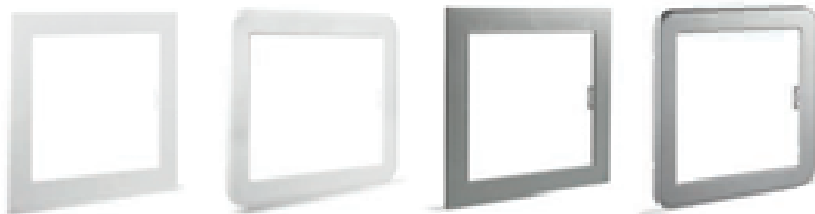

 20I					
Arenado / Sandblasted / Sablé / Sandgestrahit / Sabbbiato / Areado / Матовое / Piaskowany	 IP 54	ACT-9110-14-B9	ACT-9111-14-B9	ACT-9110-N3-B9	ACT-9111-N3-B9
Semiarenado / Semi-sand- blasted / Demi sablé/ Halb- sandgestrahit / Semi-sabbbiato / Semiareado / Полуматовое / Częściowo piaskowany	 IP 54	ACT-9115-14-F1	ACT-9116-14-F1	ACT-9115-N3-F1	ACT-9116-N3-F1
Serigrafiado / Silkscreened / Sérigraphié/ Siebdruck / Serigrafato /Serigrafado / C трафаретной печатью / Z sitodrukiem	 IP 54	ACT-9119-14-H6	ACT-9120-14-H6	ACT-9119-N3-H6	ACT-9120-N3-H6

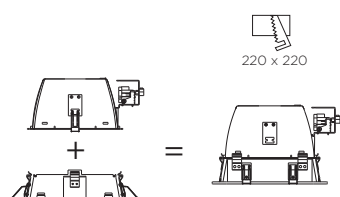

220 x 220



 58I					
Arenado / Sandblasted / Sablé / Sandgestrahit / Sabbbiato / Areado / Матовое / Piaskowany	 IP 54	ACT-9112-14-B9	ACT-9113-14-B9	ACT-9112-N3-B9	ACT-9113-N3-B9
Semiarenado / Semi-sand- blasted / Demi sablé/ Halb- sandgestrahit / Semi-sabbbiato / Semiareado / Полуматовое / Częściowo piaskowany	 IP 54	ACT-9117-14-F1	ACT-9118-14-F1	ACT-9117-N3-F1	ACT-9118-N3-F1
Serigrafiado / Silkscreened / Sérigraphié/ Siebdruck / Serigrafato /Serigrafado / C трафаретной печатью / Z sitodrukiem	 IP 54	ACT-9121-14-H6	ACT-9122-14-H6	ACT-9121-N3-H6	ACT-9122-N3-H6

MINI FRAME

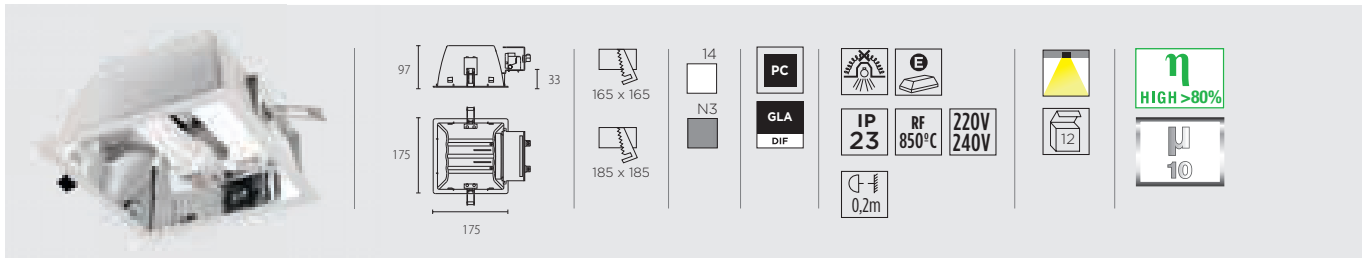

TC-DEL

G24q-2



DN-1662-14-00 ^(S)	<input type="checkbox"/>		1x18W	*
DN-1666-14-00	<input type="checkbox"/>		2x18W	

TC-DEL G24q-2 1X18W

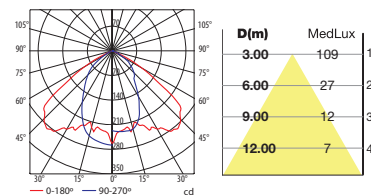

η=50%

TC-TEL

GX24q-3



DN-1663-14-00 ^(S)	<input type="checkbox"/>		1x26W	*
DN-1667-14-00	<input type="checkbox"/>		2x26W	



Para versiones con una lámpara y/o versiones con portalámparas E-27, consulte con Equipo Comercial.
 For versions with one lamp and/or versions with an E-27 light bulb socket, please contact your sales representative.
 Pour les versions à une lampe et/ou les versions à douille E-27, adressez-vous à l'équipe commerciale.
 Für Ausführungen mit einem Leuchtmittel und/oder Ausführungen mit Lampenfassung E-27 wenden Sie sich bitte an unseren Vertrieb.
 Per versioni con una lampada e/o versioni con portalampada E-27, consultare lo staff commerciale.
 Para versões com uma lâmpada e/ou versões com suporte de casquilho E-27, consulte a Equipa de Vendas.
 Для опции с одной лампой и/или с патроном E-27 обращайтесь к нашим менеджерам
 Dla wersji o jednej lampie i/lub wersji z oprawkami E-27, proszę skonsultować się z działem handlowym.

* Posibilidad de servir estas referencias sin equipo. Consulte a nuestro Equipo Comercial

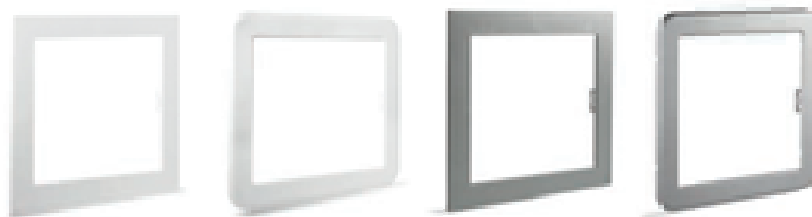
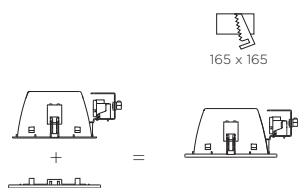

 20I					
Arenado / Sandblasted / Sablé / Sandgestraht / Sabbliato / Areado / Матовое / Piaskowany		ACT-9138-14-T2	ACT-9139-14-T2	ACT-9138-N3-T2	ACT-9139-N3-T2
Semiarenado / Semi-sand- blasted / Demi sablé/ Halb- sandgestraht / Semi-sabbliato / Semiareado / Полуматовое / Częściowo piaskowany		ACT-9142-14-T2	ACT-9143-14-T2	ACT-9142-N3-T2	ACT-9143-N3-T2
Serigrafado / Silkscreened / Sérigraphié/ Siebdruck / Serigrafato /Serigrafado / C трафаретной печати / Z sitodrukiem		ACT-9146-14-H6	ACT-9147-14-H6	ACT-9146-N3-H6	ACT-9147-N3-H6

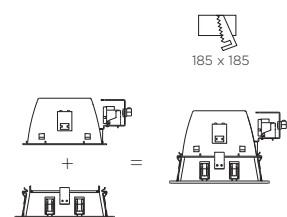

 58I					
Arenado / Sandblasted / Sablé / Sandgestraht / Sabbliato / Areado / Матовое / Piaskowany		ACT-9140-14-T2	ACT-9141-14-T2	ACT-9140-N3-T2	ACT-9141-N3-T2
Semiarenado / Semi-sand- blasted / Demi sablé/ Halb- sandgestraht / Semi-sabbliato / Semiareado / Полуматовое / Częściowo piaskowany		ACT-9144-14-T2	ACT-9145-14-T2	ACT-9144-N3-T2	ACT-9145-N3-T2
Serigrafado / Silkscreened / Sérigraphié/ Siebdruck / Serigrafato /Serigrafado / C трафаретной печати / Z sitodrukiem		ACT-9148-14-H6	ACT-9149-14-H6	ACT-9148-N3-H6	ACT-9149-N3-H6



VITRO

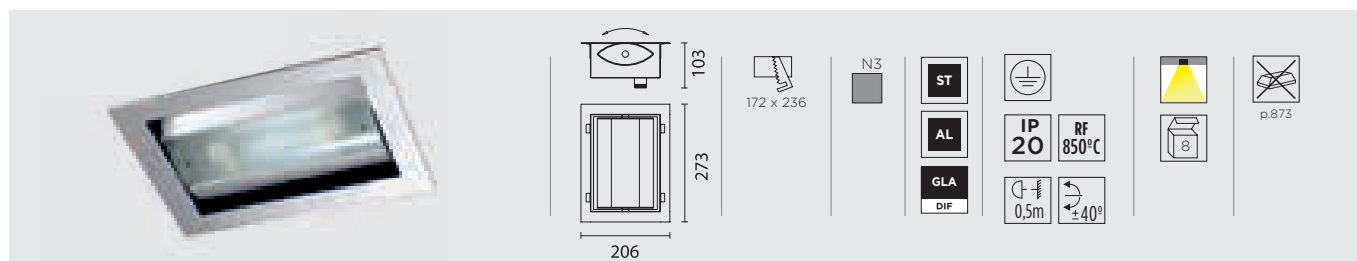

HIT-DE

RX7s

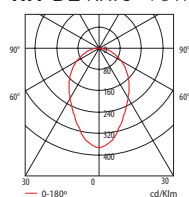
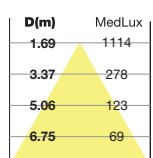
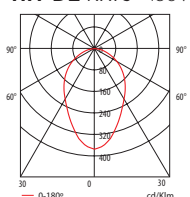
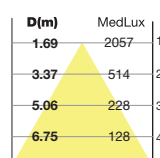

DN-0276-N3-B9^(S)		70W			
DN-0750-N3-B9^(S)		150W			

HIT-DE RX7s 70W

 $\eta=73\%$

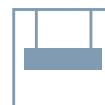
HIT-DE RX7s 150W

 $\eta=73\%$

TECHNICAL



FLUORESCENT LINEAL LIGHTING SYSTEMS

SISTEMAS DE FLUORESCENCIA LINEAL
 SYSTÈMES À FLUORESCENCE LINÉAIRE
 LINEALE LEUCHTSTOFFRÖHRENSYSTEME
 SISTEMI DI FLUORESCENZA LINEARE
 SISTEMAS LINEARES DE ILUMINAÇÃO FLUORESCENTE
 ЛИНЕЙНЫЕ ЛЮМИНЕСЦЕНТНЫЕ СИСТЕМЫ
 LINIOWE SYSTEMY FLUORESCENCYJNE



INFINITE

P. 174



INFINITE C

P. 171

	<input type="checkbox"/>	<input type="checkbox"/>
	<input type="checkbox"/>	<input type="checkbox"/>
	<input type="checkbox"/>	<input type="checkbox"/>
	<input type="checkbox"/>	<input type="checkbox"/>
1 X TL5/G5	<input type="checkbox"/>	<input type="checkbox"/>
2 X TL5/G5	<input type="checkbox"/>	<input type="checkbox"/>
39W (900mm)	<input type="checkbox"/>	<input type="checkbox"/>
54W (1200mm)	<input type="checkbox"/>	<input type="checkbox"/>
80W (1500mm)	<input type="checkbox"/>	<input type="checkbox"/>
XXXX mm	<input type="checkbox"/>	<input type="checkbox"/>
	<input type="checkbox"/>	<input type="checkbox"/>
	<input type="checkbox"/>	<input type="checkbox"/>
	<input type="checkbox"/>	<input type="checkbox"/>
<input type="checkbox"/> N3	<input type="checkbox"/>	<input type="checkbox"/>
<input type="checkbox"/> 14	<input type="checkbox"/>	<input type="checkbox"/>
	<input type="checkbox"/>	<input type="checkbox"/>



Accesorios incluidos en todas las luminarias / Accessories included in all luminaries / Accessoires inclus dans tous les luminaires / Zubehör bei allen Leuchten inklusive / Acessórios incluídos em todas as luminárias / Accessori contenuti in tutte le lampade / Аксессуары, включенные для всех светильников / Łącznie z akcesoriami we wszystkich oprawkach oświetleniowych

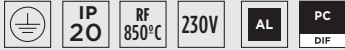

Suspendida / Suspended / En suspension / Hängelampe / A sospensione / Suspensa / Подвесной / Zawieszona

Adosada / Surface mounted / En surface / Aufbau / Montata in superficie / Montada em superfície / Поверхностный / Przylegająca

Empotrada trimless / Trimless recessed / Encastré « trimless » / A incasso trimless / Encastrada sem aro / Встроенная без рамки / Wbudowana typu trimless (bez obrzeża)

Empotrada trim / Recessed with trim / Encastré « trim » / Trim-Einbau / Trimless-Einbau / A incasso trim / Encastrada com aro / Встроенный с рамкой / Wbudowana typu trim (z obrzeżem)

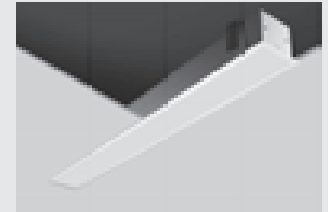
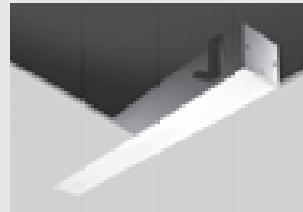
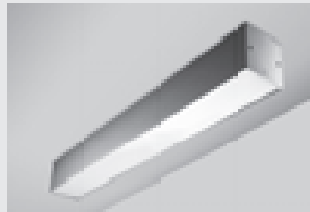
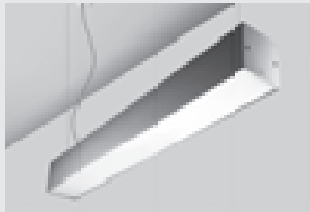

Polycarbonato / Polycarbonate / Polycarbonate / Polycarbonate / Polycarbonat / Polycarbonato / Polycarbonato / Поликарбонат / Поликарбонат / Poliwęgieln



SISTEMA OVERLAPPING / OVERLAPPING SYSTEM / SYSTÈME DE CHEVAUCHEMENT « OVERLAPPING » / OVERLAPPING-SYSTEM / SISTEMA OVERLAPPING / SISTEMA OVERLAPPING / СИСТЕМА OVERLAP / SYSTEM ZACHODZENIA NA SIEBIE

1 LÁMPARA / 1 LAMP / 1 LAMPE / 1 T5 / 1 LAMPADA / 1 LĀMPADA / 1 ЛАМПОЙ / 1 LAMPĀ

Ejemplo / Example / Exemple / Beispiel / Esempio / Exemplo / Пример / Przykład

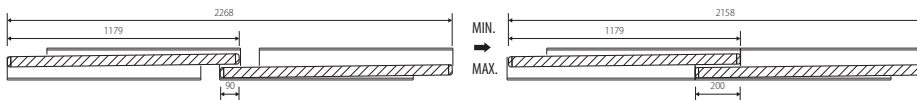

2 LÁMPARAS / 2 LAMPS / 2 LAMPES / 2 T5 / 2 LAMPADE / 2 LĀMPADAS / 2 ЛАМПАМИ / 2 LAMPAMI

Ejemplo / Example / Exemple / Beispiel / Esempio / Exemplo / Пример / Przykład

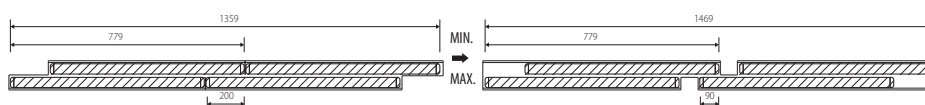
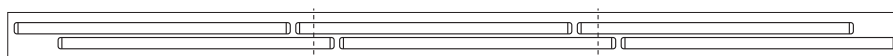

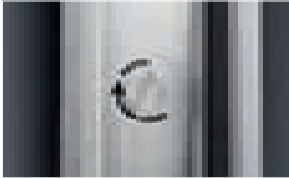

Fácil instalación / Easy installation /
Installation facile/ Einfacher Einbau / Facile
installazione / Instalação fácil / Простой
монтаж / Łatwy montaż

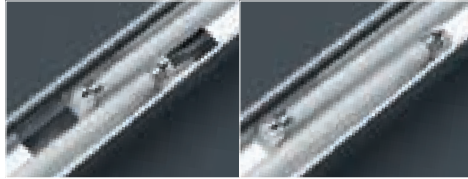

Sistema overlapping / Overlapping system / Système de chevauchement « overlapping » / Overlapping-System / Sistema overlapping /
Sistema de sobreposição "overlapping" / Система overlap / System zachodzenia na siebie

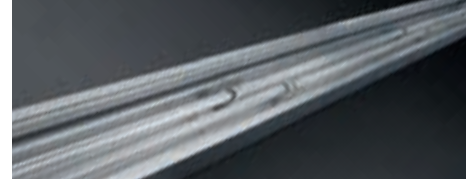

INSTALACIÓN EMPOTRADO TRIMLESS / TRIMLESS RECESSED INSTA-
LLATION / INSTALLATION ENCASTRÉE « TRIMLESS » / EINBAUMONTAGE
OHNE RAMEN / INSTALLAZIONE A INCASSO TRIMLESS / INSTALAÇÃO
ENCASTRADA SEM ARO / ВСТРОЕННЫЙ МОНТАЖ БЕЗ РАМКИ / INSTA-
LACJA WBUDOWANA TYPU TRIMLESS (BEZ OBRZEŻA)ВСТРОЕННЫЙ

INSTALACIÓN EMPOTRADO TRIM / TRIM RECESSED INSTALLATION / INSTA-
LLATION ENCASTRÉE TRIM / EINBAUMONTAGE MIT RAHMEN / INSTALLAZIONE
A INCASSO TRIM / INSTALAÇÃO ENCASTRADA COM ARO / ВСТРОЕННЫЙ
МОНТАЖ С РАМКОЙ / INSTALACJA WBUDOWANY TYPU TRIM (Z OBRZEŻEM)
ВСТРОЕННЫЙ МОНТАЖ С РАМКОЙ



Kits de rápida instalación. Ajustable a techos de 5mm a 25 mm.
Quick installation kits. Adjustable to the ceiling thickness from 5mm to 25mm.
Kits d'installation rapide. Adaptable à plafonds de 5 mm à 25 mm.
Kits zur schnellen Installation. Für Decken von 5 mm bis 25 mm regulierbar.
Kit di installazione rapida. Regolabile su soffitti da 5mm a 25mm.
Kits de instalação rápida. Ajustável a tectos de 5 mm a 25 mm.
Набор для быстрого монтажа. Расчитан на потолки толщиной от 5 до 25 мм.
Zestawy do szybkiego montażu. Regulowane do sufitów wynoszących od 5mm do 25mm.

INFORMACIÓN PARA EFECTUAR EL PEDIDO / ORDERING INFORMATION / INFORMATIONS NÉCESSAIRES À LA COMMANDE / INFORMATION
FÜR BESTELLUNGEN / COME EFFETTUARE L'ORDINE / INFORMAÇÕES NECESSÁRIAS PARA EFETUAR A ENCOMENDA / ИНФОРМАЦИЯ ДЛЯ
ОФОРМЛЕНИЯ ЗАКАЗА / INFORMACJE DLA DOKONANIA ZAMÓWIENIA

Sistema de codificación / Codification system / Système de codification / Zusammensetzung der Bestellnummern / Sistema di codificazione /
Sistema de codificação / Система кодификации / System kodowania

PASO 1 / STEP 1 / ÉTAPE 1 / SCHRITT 1 / FASE 1 / PASSO 1 / ШАГ 1 / KROK 1

Elija el perfil para 1 o 2 lámparas T5 / Choose the profil for 1 or 2 T5 lamps / Choisissez le profil pour 1 ou 2 lampes T5 / Profil für 1 oder 2 Lampen vom Typ T5 auswählen /
Scegliere il profilo per 1 o 2 lampade T5 / Escolha o perfil para 1 ou 2 lâmpadas T5 / Выберите профиль для 1 или 2 ламп T5 / Proszę wybrać profil dla 1 lub 2 lamp T5

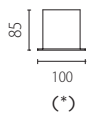
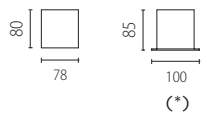

(*)

L1: Lineal continuo de 1 lámpara T5
Continuous lineal for 1 T5 lamp
Linéaire continu 1 lampe T5
Kontinuierlich lineal mit 1 T5-Lampe
Lineare continuo di 1 lampada T5
Linear continuo de 1 lâmpada T5
Линейный светильник непрерывного освещения на 1 лампу T5
Liniový stýly dla 1 lampy T5

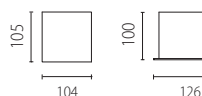
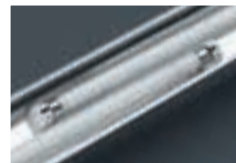

(*)

L2: Lineal continuo de 2 lámparas T5
Continuous lineal for 2 T5 lamps
Linéaire continu 2 lampes T5
Kontinuierlich lineal mit 2 T5-Lampen
Lineare continuo di 2 lampade T5
Linear continuo de 2 lâmpadas T5
Линейный светильник непрерывного освещения на 2 лампы T5
Liniový stýly dla 2 lampy T5

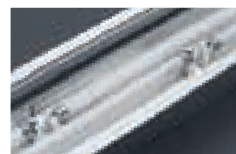

Para versiones empotradas, perfil con marco. / For recessed versions, profile with trim. / Pour versions encastrées, profil avec cadre / Für Einbaumodelle Profil mit Rahmen wählen /
Per versioni a incasso, profilo con bordo / Para versões encastradas, perfil com aro / Для встроенных моделей – профиль с рамкой / Dla wersji wbudowanych profil z obramowaniem

PASO 2 / STEP 2 / ÉTAPE 2/ SCHRITT 2 / PASSO 2 / FASE 2/ ШАГ 2/ KROK 2

Elija su aplicación / Choose your application / Choisissez votre application / Montageart wählen / Scegliere applicazione / Escolha a sua aplicação / Выберите тип монтажа / Proszę wybrać swoje zastosowanie

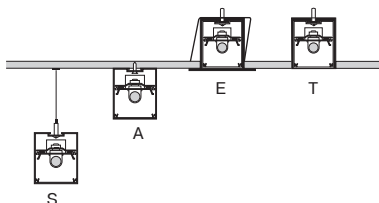

S: Suspendido / Suspended / En suspension / Aufhängung / A sospensione / Suspensa / Подвесной / Zawieszona
A: Adosado / Surface mounted / En surface / Aufbaumontage / Montata in superficie / Montada em superfície / Поверхностный / Przylegająca
E: Empotrado / Recessed / Encastré / Einbaumontage / Ad incasso / Encastrada / Встроенный / Wbudowany
T: Empotrada trimless / Trimless recessed / Encastré « trimless » / Einbaumontage ohne Rahmen / Ad incasso trimless / Encastrada sem aro / Встроенный без рамки / Wbudowana typu trimless (bez obrzeża)

PASO 3 / STEP 3 / ÉTAPE 3/ SCHRITT 3 / PASSO 3 / FASE 3/ ШАГ 3/ KROK 3

Elija la longitud que necesite en milímetros (5 dígitos) / Choose the length required in millimeters (5 digits) / Choisissez la longueur nécessaire en millimètres (5 chiffres) / Länge in mm wählen (5 Stellen) / Escolha o comprimento necessário em milímetros (5 dígitos) / Scegliere la lunghezza necessaria in millimetri (5 cifre) / Выберите необходимую длину в мм (5 знаков) / Proszę wybrać długość jaką potrzebuje się w milimetrach (5 cyfr)

Ejemplo/ Example / Exemple / Beispiel / Esempio / Exemplo / Пример / Przykład:

02530 = 2,53 metros/ 2,53 meters

02570 = 2,57 metros/ 2,57 meters

10680 = 10,68 metros/ 10,68 meters

PASO 4 / STEP 4 / ÉTAPE 4/ SCHRITT 4 / PASSO 4 / FASE 4/ ШАГ 4/ KROK 4

Haga su pedido / Make your order / Passez commande / Bestellung aufgabe / Faça a sua encomenda / Effettuare l'ordine / Оформите заказ / Proszę wykonać zamówienie

1	2	3
N.º lámparas T5 #T5 lamps Nombre de lampes T5 Anzahl T5-Lampen N.º di lampade T5 N.º lâmpadas T5 Кол-во ламп T5 Ilość lamp T5	aplicación application Montageart Applicazione Aplicação Монтаж Zastosowanie	longitud en mm length in mm Longueur en mm Länge in mm Lunghezza in mm Comprimento em mm Длина в мм Długość w mm
L1 L2	S A E T	XXXXX

Ejemplo/ Example / Exemple / Beispiel / Esempio / Exemplo / Пример / Przykład:

L1-A-02530 = Lineal continuo de 1 T5 adosado de 2, 53 metros.
 Surfaced mounted continuous row for 1 T5 lamp with 2,53 meters.
 Linéaire continu de 1 T5 en surface de 2,53 mètres
 Kontinuierlich lineal mit 1 x T5, Oberfläche, 2,53 m.
 Lineare continuo di 1 T5 montata in superficie di 2,53 metri

Linear continuo de 1 T5 montada à superfície de 2,53 metros.
 Линейный светильник непрерывного освещения на 1 лампу T5, для поверхностного монтажа длиной 2,53 метра
 Liniowy stały 1 T5 przylegający o 2,53 metra

Para versiones con regulación DALI o 1..10V consulte con su comercial.
 Para elegir la potencia (39W-54W-80W) consulte con su comercial.
 Para realizar combinaciones con tramos ciegos consulte con su comercial.
 Para versiones empotradas con perfil sin marco consulte con su comercial.

For versions with Dali dimmable system or 1 to 10v, please contact your sales representative.
 To choose the desired power, please contact your sales representative.
 To achieve blind sections, please contact your sales representative.
 For trimless recessed versions, please contact your sales representative.

Consultez votre commercial pour les versions à réglage DALI ou 1-10 V.
 Consultez votre commercial pour choisir la puissance (39W-54W-80W).
 Consultez votre commercial pour réaliser des combinaisons à portions aveugles.
 Consultez votre commercial pour les versions encastrées à profil sans cadre.

Für Ausführungen mit DALI-REGULIERUNG oder 1..10V wenden Sie sich bitte an Ihren Händler.
 Um die passende Leistung zu wählen (39W-54W-80W), wenden Sie sich bitte an Ihren Händler.
 Für Kombinationen mit Blindabschnitten wenden Sie sich bitte an unseren vertreib.
 Für Einbaumodelle mit Profil ohne Rahmen wenden Sie sich bitte an unseren vertreib.

Per versioni con regolazione DALI o 1..10V, consultare il proprio commerciale.
 Per scegliere la potenza (39W-54W-80W) consultare il proprio commerciale.
 Per realizzare combinazioni con tratto cieco consultare il proprio commerciale. OK
 Per versioni a incasso con profilo senza bordo consultare il proprio commerciale.

Para versões com regulação DALI 1...10 V, consulte o seu comercial
 Para escolher a potência desejada (39 W/54 W/80 W) consulte o seu comercial
 Para realizar combinações com secções cegas consulte o seu comercial
 Para versões encastradas com perfil sem aro consulte o seu comercial

По поводу моделей с регулировкой DALI или 1-10 вольт, обращайтесь к нашим менеджерам
 Для выбора энергопотребления (39 - 54 - 80 ватт) обратитесь к менеджеру.
 По вопросам комбинации ламп и глухих участков обращайтесь к менеджеру
 Расчет моделей, встраиваемых без использования рамки, обращайтесь к менеджеру

Dla wersji z regulacją DALI lub 1..10V, proszę skonsultować się ze swoim handlowcem
 Dla wybrania mocy (39W-54W-80W) proszę skonsultować się z Państwa handlowcem.
 Dla wykonania zestawień ze ślepyimi odcinkami proszę skonsultować się z Państwa handlowcem
 Dla wersji wbudowanych o profilu bez obramowania proszę skonsultować się z Państwa handlowcem

Accesorios / Accessories / Accessoires / Zubehöre / Accessori / Acessórios / Аксессуары / Akcesoria

Necesarios / Required / Nécessaires / Notwendig / Indispensabili / Necessários / Необходимые / Konieczne Opcionales / Optional / En option / Opzionale / Opzionali / Opcionais / По желанию / Do wyboru

			(78mm)		
ACT-9091-N3-00 2 units/ref Sirgas / Steel cord / Câble de suspension / Stahnkabel / Cavi in acciaio / Cabos de suspensão / Тросы / Liny	ACT-9090-14-00 <input type="checkbox"/> ACT-9090-N3-00 <input checked="" type="checkbox"/> (standard) Florón / Power supply unit / Base d'alimentation / Netzteil / Base d'alimentazione / Base de alimentação / Защитно-декоративный колпачок / Podsufitka	ACT-9083-N3-00 <input checked="" type="checkbox"/> (1-10V or DALI)	ACT-9114-00-00 Kit unión perfil / Profile union kit / Kit de raccord profil / Verbindungskit Profil / Kit di unione profilo / Kit de união perfil / Набор соединительный для профиля / Zestaw łączący profil	ACT-9150-14-M1 <input type="checkbox"/> ACT-9150-N3-M1 <input checked="" type="checkbox"/> Conector 90° con difusor policarbonato / L-shape connector + PC cover / Connecteur 0° avec diffuseur polycarbonate / 90-Grad-Stecker mit Diffusor aus Polykarbonat / Connettore 90° con diffusore di policarbonato / Conector 90° com difusor de policarbonato / Уголок соединительный L-образный с рассеивателем из поликарбоната / Złączka 90° z poliwęglanowym dyfuzorem	ACT-9154-14-M1 <input type="checkbox"/> ACT-9154-N3-M1 <input checked="" type="checkbox"/> Conector T con difusor policarbonato / T-shape connector + PC cover / Connecteur en T avec diffuseur polycarbonate / T-Stecker mit Diffusor aus Polykarbonat / Connettore a T con diffusore di policarbonato / Conector T con difusor de policarbonato / Соединитель T-образный с рассеивателем из поликарбоната / Złączka w kształcie T z poliwęglanowym dyfuzorem
(78mm) ACT-9092-00-00 2 units/ref Kit para empotrar perfil trimless / Trimless recessed kit / Kit d'encastrement profil « trimless » / Einbaukit Profil ohne Rahmen / Kit per incasso profilo trimless / Kit para encastrar o perfil sem aro / Набор для встроенного монтажа профиля без рамки / Zestaw do wbudowania profilu typu trimless (bez obrzeża)					
(100mm) INCLUDED Kit para empotrar perfil trim / Trim recessed kit / Kit d'encastrement profil « trim » / Einbaukit Profil mit Rahmen / Kit per incasso profilo trim / Kit para encastrar o perfil com aro / Набор для встроенного монтажа профиля с рамкой / Zestaw do wbudowania profilu typu trim (z obrzeżem)			(100mm) ACT-9096-00-00		
			Kit unión perfil / Profile union kit / Kit de raccord profil / Verbindungskit Profil / Kit di unione profilo / Kit de união perfil / Набор соединительный для профиля / Zestaw łączący profil	Conector 90° con difusor policarbonato / L-shape connector + PC cover / Connecteur 0° avec diffuseur polycarbonate / 90-Grad-Stecker mit Diffusor aus Polykarbonat / Connettore 90° con diffusore di policarbonato / Conector 90° com difusor de policarbonato / Уголок соединительный L-образный с рассеивателем из поликарбоната / Złączka 90° z poliwęglanowym dyfuzorem	
			(78mm) ACT-9114-00-00		
ACT-9091-N3-00 2 units/ref Sirgas / Steel cord / Câble de suspension / Stahnkabel / Cavi in acciaio / Cabos de suspensão / Тросы / Liny	ACT-9090-14-00 <input type="checkbox"/> ACT-9090-N3-00 <input checked="" type="checkbox"/> (standard) Florón / Power supply unit / Base d'alimentation / Netzteil / Base d'alimentazione / Base de alimentação / Защитно-декоративный колпачок / Podsufitka	ACT-9083-N3-00 <input checked="" type="checkbox"/> (1-10V or DALI)	Kit unión perfil / Profile union kit / Kit de raccord profil / Verbindungskit Profil / Kit di unione profilo / Kit de união perfil / Набор соединительный для профиля / Zestaw łączący profil		
(78mm) ACT-9092-00-00 2 units/ref Kit para empotrar perfil trimless / Trimless recessed kit / Kit d'encastrement profil « trimless » / Einbaukit Profil ohne Rahmen / Kit per incasso profilo trimless / Kit para encastrar o perfil sem aro / Набор для встроенного монтажа профиля без рамки / Zestaw do wbudowania profilu typu trimless (bez obrzeża)					
(100mm) INCLUDED Kit para empotrar perfil trim / Trim recessed kit / Kit d'encastrement profil « trim » / Einbaukit Profil mit Rahmen / Kit per incasso profilo trim / Kit para encastrar o perfil com aro / Набор для встроенного монтажа профиля с рамкой / Zestaw do wbudowania profilu typu trim (z obrzeżem)			(100mm) ACT-9096-00-00		
			Kit unión perfil / Profile union kit / Kit de raccord profil / Verbindungskit Profil / Kit di unione profilo / Kit de união perfil / Набор соединительный для профиля / Zestaw łączący profil		

INFINITE 2XT5

Todas las luminarias vienen suministradas con tapas y balastro electrónico. / All luminaires are supplied with end caps and electronic ballast. / Tous les luminaires sont fournis avec caches et ballast électronique / Alle Leuchten werden mit Deckeln und elektronischem Vorschaltgerät geliefert / Tutte le lampade vengono fornite con coperchi e ballast elettronico / Todas as luminárias são fornecidas com topos e balastro eletrônico. / Все светильники поставляются с заглушками и электронным балластом / Wszystkie oprawy oświetleniowe są dostarczane z zaślepkami i statecznikiem elektronicznym.



 <p>Polycarbonato / Polycarbonate / Polycarbonato / Polycarbonat / Polycarbonato / Polycarbonato / Поликарбонат / Poliwęgiel</p>	2x39W (900mm)	AD-0665-N3-00  (standard)	Suspendida Suspended En suspension Hängeleuchte A sospensione Suspensa Подвесной Zawieszona	 		
	2x39W (900mm)	AD-0689-N3-00  (1-10V)				
	2x39W (900mm)	AD-0700-N3-00  (DALI)				
	2x54W (1200mm)	AD-0666-14-00  (standard)	Adosada Surface mounted En surface Aufbauleuchte Montata in superficie Montada em superficie Поверхностный Natynkowa	 		
	2x54W (1200mm)	AD-0666-N3-00  (standard)				
	2x54W (1200mm)	AD-0690-14-00  (1-10V)				
	2x54W (1200mm)	AD-0690-N3-00  (1-10V)	Empotrada trimless Trimless recessed Encastré « trimless » Einbauleuchte ohne Rahmen A incasso trimless Encastrada sem aro Встроенный без рамки Wbudowana typu trimless (bez obrzeża)			
	2x54W (1200mm)	AD-0701-14-00  (DALI)				
	2x54W (1200mm)	AD-0701-N3-00  (DALI)				
	2x39W (900mm)	EP-1626-14-00  (standard)	Empotrada trim Recessed with trim Encastré « trim » Einbauleuchte mit Rahmen A incasso trim Encastrada com aro Встроенная с рамкой Wbudowana typu trim (z obrzeżem)			
EP-1649-14-00  (1-10V)						
EP-1660-14-00  (DALI)						
2x54W (1200mm)		EP-1627-14-00  (standard)				
		EP-1650-14-00  (1-10V)				
		EP-1661-14-00  (DALI)				

 <p>Doble parabólica / Double parabolic / Double parabol / Doppelparabol / Doppia parabola / Duple parabólica / Двойной параболический / Podwójna parabola</p>	2x39W (900mm)	AD-0662-N3-00  (standard)	Suspendida Suspended En suspension Hängeleuchte A sospensione Suspensa Подвесной Zawieszona	 		
	2x39W (900mm)	AD-0686-N3-00  (1-10V)				
	2x39W (900mm)	AD-0697-N3-00  (DALI)				
	2x54W (1200mm)	AD-0663-14-00  (standard)	Adosada Surface mounted En surface Aufbauleuchte Montata in superficie Montada em superficie Поверхностный Natynkowa	 		
	2x54W (1200mm)	AD-0687-14-00  (1-10V)				
	2x54W (1200mm)	AD-0687-N3-00  (1-10V)				
	2x54W (1200mm)	AD-0698-14-00  (DALI)				
	2x54W (1200mm)	AD-0698-N3-00  (DALI)	Empotrada trimless Trimless recessed Encastré « trimless » Einbauleuchte ohne Rahmen A incasso trimless Encastrada sem aro Встроенный без рамки Wbudowana typu trimless (bez obrzeża)			
	2x80W (1500mm)	AD-0664-N3-00  (standard)				
	2x80W (1500mm)	AD-0688-N3-00  (1-10V)				
2x80W (1500mm)	AD-0699-N3-00  (DALI)					
2x39W (900mm)	EP-1623-14-00  (standard)	Empotrada trim Recessed with trim Encastré « trim » Einbauleuchte mit Rahmen A incasso trim Encastrada com aro Встроенная с рамкой Wbudowana typu trim (z obrzeżem)				
	EP-1646-14-00  (1-10V)					
	EP-1657-14-00  (DALI)					
	EP-1624-14-00  (standard)					
	EP-1647-14-00  (1-10V)					
2x54W (1200mm)	EP-1658-14-00  (DALI)					
	EP-1625-14-00  (standard)					
	EP-1648-14-00  (1-10V)					
2x80W (1500mm)	EP-1659-14-00  (DALI)					

* Posibilidad de servir estas referencias sin equipo. Consulte a nuestro Equipo Comercial

Accesorios / Accessories / Accessoires / Zubehöre / Accessori / Acessórios / Аксессуары / Akcesoria

Necesarios / Required / Nécessaires / Notwendig / Indispensabili / Necessários / Необходимые / Konieczne Opcionales / Optional / En option / Opzionale / Opzionale / Opcionais / По желанию / Do wyboru

ACT-9091-N3-00 2 units/ref	ACT-9090-14-00 ACT-9090-N3-00 (standard)	ACT-9083-N3-00 (1-10V or DALI)	ACT-9097-00-00	ACT-9151-14-M1 ACT-9151-N3-M1	ACT-9155-14-M1 ACT-9155-N3-M1
Sirgas / Steel cord / Câble de suspension / Stahlkabel / Cavi in acciaio / Cabos de suspensão / Тросы / Liny	Florón / Power supply unit / Base d'alimentation / Netzteil / Base d'alimentazione / Base de alimentação / Защитно-декоративный колпачок / Podsufitka	(1-10V or DALI)	Kit unión perfil / Profile union kit / Kit de raccord profil / Verbindungskit Profil / Kit di unione profilo / Kit de união perfil / Набор соединительный для профиля / Zestaw łączący profil	Conector 90° con difusor policarbonato / L-shape connector + PC cover / Connecteur 0° avec diffuseur polycarbonate / 90-Grad-Stecker mit Diffusor aus Polykarbonat / Connettore 90° con diffusore di policarbonato / Conector 90° com difusor de policarbonato / Уголок соединительный L-образный с рассеивателем из поликарбоната / Złączka 90° z poliwęglanowym dyfuzorem	Conector T con difusor policarbonato / T-shape connector + PC cover / Connecteur en T avec diffuseur polycarbonate / T-Stecker mit Diffusor aus Polykarbonat / Connettore a T con diffusore di policarbonato / Conector T com difusor de policarbonato / Соединитель T-образный с рассеивателем из поликарбоната / Złączka w kształcie T z poliwęglanowym dyfuzorem
ACT-9093-00-00 2 units/ref					
Kit para empotrar perfil trimless / Trimless recessed kit / Kit d'encastrement profil « trimless » / Einbaukit Profil ohne Rahmen / Kit per incasso profilo trimless / Kit para encastrar o perfil sem aro / Набор для встроенного монтажа профиля без рамки / Zestaw do wbudowania profilu typu trimless (bez obrzeża)					
INCLUDED	ACT-9097-00-00	ACT-9153-14-M1			
Kit para empotrar perfil trim / Trim recessed kit / Kit d'encastrement profil « trim » / Einbaukit Profil mit Rahmen / Kit per incasso profilo trim / Kit para encastrar o perfil com aro / Набор для встроенного монтажа профиля с рамкой / Zestaw do wbudowania profilu typu trim (z obrzeżem)	Kit unión perfil / Profile union kit / Kit de raccord profil / Verbindungskit Profil / Kit di unione profilo / Kit de união perfil / Набор соединительный для профиля / Zestaw łączący profil	Conector 90° con difusor policarbonato / L-shape connector + PC cover / Connecteur 0° avec diffuseur polycarbonate / 90-Grad-Stecker mit Diffusor aus Polykarbonat / Connettore 90° con diffusore di policarbonato / Conector 90° com difusor de policarbonato / Уголок соединительный L-образный с рассеивателем из поликарбоната / Złączka 90° z poliwęglanowym dyfuzorem			
ACT-9091-N3-00 2 units/ref	ACT-9090-14-00 ACT-9090-N3-00 (standard)	ACT-9083-N3-00 (1-10V or DALI)	ACT-9097-00-00		
Sirgas / Steel cord / Câble de suspension / Stahlkabel / Cavi in acciaio / Cabos de suspensão / Тросы / Liny	Florón / Power supply unit / Base d'alimentation / Netzteil / Base d'alimentazione / Base de alimentação / Защитно-декоративный колпачок / Podsufitka	(1-10V or DALI)	Kit unión perfil / Profile union kit / Kit de raccord profil / Verbindungskit Profil / Kit di unione profilo / Kit de união perfil / Набор соединительный для профиля / Zestaw łączący profil		
ACT-9093-00-00 2 units/ref					
Kit para empotrar perfil trimless / Trimless recessed kit / Kit d'encastrement profil « trimless » / Einbaukit Profil ohne Rahmen / Kit per incasso profilo trimless / Kit para encastrar o perfil sem aro / Набор для встроенного монтажа профиля без рамки / Zestaw do wbudowania profilu typu trimless (bez obrzeża)					
INCLUDED	ACT-9097-00-00				
Kit para empotrar perfil trim / Trim recessed kit / Kit d'encastrement profil « trim » / Einbaukit Profil mit Rahmen / Kit per incasso profilo trim / Kit para encastrar o perfil com aro / Набор для встроенного монтажа профиля с рамкой / Zestaw do wbudowania profilu typu trim (z obrzeżem)	Kit unión perfil / Profile union kit / Kit de raccord profil / Verbindungskit Profil / Kit di unione profilo / Kit de união perfil / Набор соединительный для профиля / Zestaw łączący profil				

INFINITE WALL WASHER

1XT5

Todas las luminarias vienen suministradas con tapas y balastro electrónico. / All luminaries are supplied with end caps and electronic ballast. / Tous les luminaires sont fournis avec caches et ballast électronique / Alle Leuchten werden mit Deckeln und elektronischem Vorschaltgerät geliefert / Tutte le lampade vengono fornite con copercchi e ballast elettronico / Todas as luminárias são fornecidas com topos e balastro eletrônico / Все светильники поставляются с заглушками и электронным балластом / Wszystkie oprawy oświetleniowe są dostarczane z zaślepkami i statecznikiem elektronicznym.



	Suspendida / Suspended / En suspension / Hängelampe / Suspensa / A sospensione / Подвесной / Zawieszona	Adosada / Surface mounted / En surface / Aufbau / Montata in superficie / Montada em superficie / Поверхностный / Natynkowa	Empotrada trimless / Trimless recessed / Encastré «trimless» / Einbau ohne Rahmen / Encastrada sem aro / Encastrada trimless / Встроенный без рамки / Wbudowana typu trimless (bez obrzeża)	Empotrada trim / Recessed with trim / Encastré «trim» / Einbau mit Rahmen / Trim-Einbau / Trimless-Einbau / Encastrada com aro / Encastrada trim / Встроенный без рамки / Wbudowana typu trim (z obrzeżem)
Reflector asimétrico / Asymmetrical reflector / Réflecteur asymétrique / Asymmetrischer Reflektor / Reflektor asimétrico / Riflettore asimétrico / Ассиметричный отражатель / Асиметричний odbłyśnik				
54W (1200mm)	AD-0654-N3-00 (standard)			EP-1615-14-00 (standard)
Accesorios / Accessories / Accessoires / Zubehöre / Accessori / Acessórios / Akcesoria / Аксессуары				
Necesarios / Required / Nécessaires / Notwendig / Indispensable / Necessários / Необходимые / Konieczne				
	ACT-9091-N3-00 2 units/ref		ACT-9093-00-00 2 units/ref	INCLUDED
	Sirgas / Steel cord / Câble de suspension / Cabos de suspensão / Cavi in acciaio / Stahlkabel / Тросы / Liny		Kit para empotrar perfil trimless / Trimless recessed kit / Kit d'encastrement profil «trimless» / Einbaukit Profil ohne Rahmen / Kit per incasso profilo trimless / Kit para encastrar o perfil sem aro / Набор для встроенного монтажа профиля без рамки / Zestaw do wbudowania profilu typu trimless (bez obrzeża)	Kit para empotrar perfil trim / Trim recessed kit / Kit d'encastrement profil «trim» / Einbaukit Profil mit Rahmen / Kit per incasso profilo trim / Kit para encastrar o perfil com aro / Набор для встроенного монтажа профиля с рамкой / Zestaw do wbudowania profilu typu trim (z obrzeżem)
ACT-9090-N3-00				
Florón / Power supply unit / Base d'alimentation / Netzteil / Base de alimentação / Base d'alimentazione / Защитно-декоративный колпачок / Podsufitka				
Opcionales / Optional / En option / Optional / Opcionais / По желанию / Do wyboru				
	ACT-9097-00-00 (104mm)			ACT-9097-00-00 (126mm)
	Kit unión perfil / Profile union kit / Kit de raccord profil / Verbindungskit Profil / Kit di unione profilo / Kit de união perfil / Набор соединительный для профиля / Zestaw łączący profil			Kit unión perfil / Profile union kit / Kit de raccord profil / Verbindungskit Profil / Kit di unione profilo / Kit de união perfil / Набор соединительный для профиля / Zestaw łączący profil

* Posibilidad de servir estas referencias sin equipo. Consulte a nuestro Equipo Comercial

FOTOMETRIÁS SERIE INFINITE / PHOTOMETRICS FOR THE INFINITE SERIES / PHOTOMÉTRIÉS SÉRIE INFINITE / FOTOMETRICHE DATEN INFINITE / CURVE FOTOMETRICHE SERIE INFINITE / FOTOMETRIAS SÉRIE INFINITE / ФОТОМЕТРИЧЕСКИЕ ПОКАЗАТЕЛИ СЕРИИ INFINITE / POMIARY ŚWIETLNE SERII INFINITE

TL5 G5 1x39W double parabolic

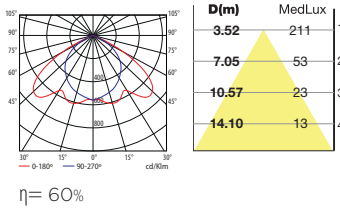

TL5 G5 1x54W double parabolic

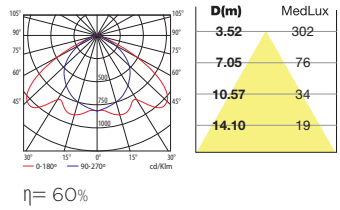

TL5 G5 1x80W double parabolic

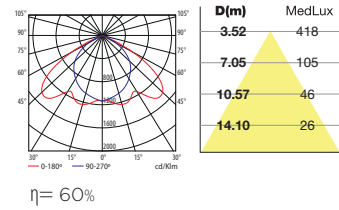

TL5 G5 1x39W polycarbonate

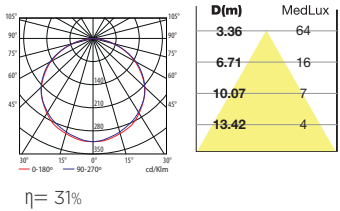

TL5 G5 1x54W polycarbonate

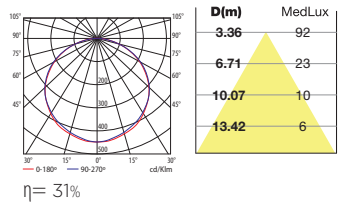

TL5 G5 1x80W polycarbonate

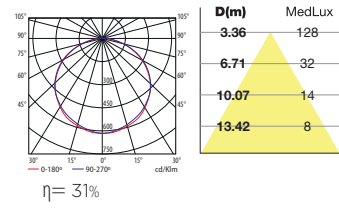

TL5 G5 2x39W double parabolic

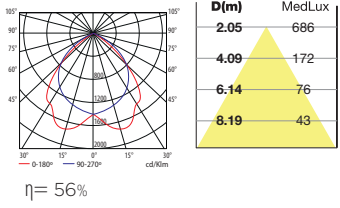

TL5 G5 2x54W double parabolic

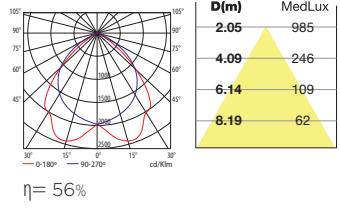

TL5 G5 2x80W double parabolic

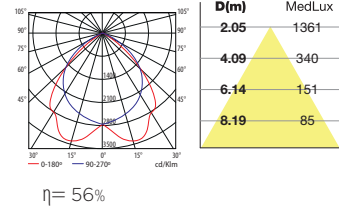

TL5 G5 2x39W polycarbonate

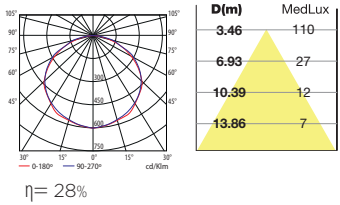

TL5 G5 2x54W polycarbonate

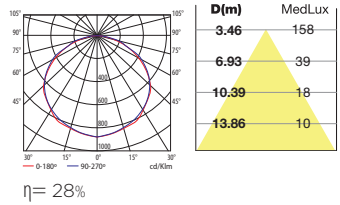

TL5 G5 1x54W asymmetrical reflector

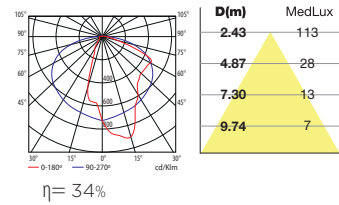

TECHNICAL

MULTIDIR



LEO 



EXIT 



BACO



P. 182

PAG. 184

P. 136

P. 132

QR-111/G53

■

■

■

AR-111/GU10

■

■

AR-111/G53

■

■

CDM-R111/GX8.5

■

■

■

HIT-TC/G8.5

■

T5/G5

INDUCTION

LED

2,2W

■



■

■

■ (1)

■

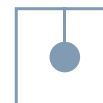

SUSPENDED

SUSPENDIDOS
SUSPENSIONS
HÄNGELEUCHTEN
SOSPENSIONI
SUSPENSÕES
ПОДВЕЧНЫЕ
ZWIEZHANE

FIT / ECOFIT 



P. 156

INFINITE



P. 171

BAY LIGHT



P. 186

BAY LIGHT



P. 186

■ (1)

■

■

■

(1) Sólo en algunas versiones / Only in some versions



MULTIDIR

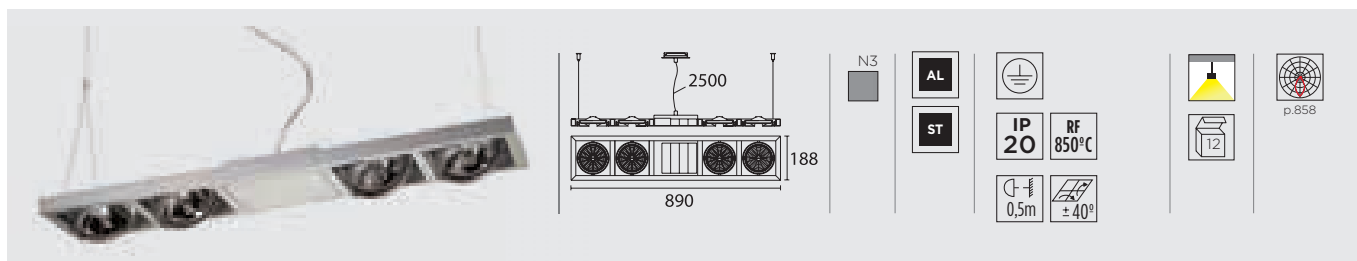

QR-111 /AR-111

G53

SP-0105-N3-00

4 x max.60W

**220V
240V**

9-14



Posibilidad de combinaciones (CDM-R111+QR-111+AR-111) bajo pedido
 Different lamp combinations (CDM-R111+QR-111+AR-111) available upon request
 Possibilit  de combinaisons (CDM-R111+QR-111+AR-111) sur commande
 Kombinationen (CDM-R111+QR-111+AR-111) auf Anfrage
 Combinazioni possibili (CDM-R111+QR-111+AR-111) disponibili su richiesta
 Possibilidade de combina es (CDM-R111+QR-111+AR-111) mediante pedido
 Możliwość zestawiania (CDM-R111+QR-111+AR-111) na zamówienie
 Возможность комбинирования ламп (CDM-R111+QR-111+AR-111) по заказу

AR-111

GU10

SP-1810-N3-00

4 x -

**110V
240V**

22-25



Accesorios / Accessories / Accessoires / Zubeh re / Accessori / Acess rios / Аксессуары / Akcesoria

ACT-9131-11-00

QR-111

ACT-9131-08-00

QR-111

ACT-9131-25-00

QR-111

ACT-9131-24-00

QR-111







LEO

NEW

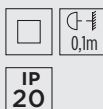
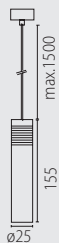

LED



00-2689-S2-00



Warm W 3000K

2,2W





La inducción es la fuente de luz idónea para la iluminación de grandes áreas.

- Encendido inmediato y compatible con sensores crepusculares o de presencia.
- Alta eficiencia luminica (>80 lm/W).
- Lámpara de larga vida útil (>100.000h), permitiendo reducir los costes de mantenimiento frente a las lámparas de descarga.
- Precio competitivo frente a la iluminación LED.

Induction is a suitable light source for the illumination of large areas.

- Immediate turn on and compatible with twilight or presence sensors.
- High luminous efficiency (>80 lm/W).
- Long lamp service life (>100,000 h), enabling you to reduce maintenance costs when comparing this lighting to discharge lamps.
- Competitive price compared to that of LED lighting.

L'induction est la source de lumière idéale pour éclairer de vastes surfaces.

- Allumage immédiat et compatible avec capteurs crépusculaires ou de présence.
- Efficience lumineuse élevée (>80 lm/W).
- Lampe à longue durée de vie utile (>100 000 h), ce qui permet de réduire les coûts d'entretien face aux lampes à décharge.
- Prix compétitif par rapport à l'éclairage LED.

Induktion ist die geeignete Lichtquelle zur Beleuchtung großer Zonen.

- unmittelbares Einschalten und Kompatibilität mit Dämmungssensoren und Bewegungsmeldern
- hohe Leuchtleistung (>80 lm/W)
- Lampe mit langer Lebensdauer (>100.000 Std.) und dadurch geringere Instandhaltungskosten im Vergleich zu Gasentladungslampen
- Preisvorteil gegenüber LED-Beleuchtung

L'induzione è la fonte di luce adatta all'illuminazione di grandi aree.

- Accensione immediata e compatibile con sensori crepuscolari o di presenza.
- Alta efficienza luminosa (>80 lm/W).
- Lampada di lunga vita utile (>100.000h) che consente di ridurre i costi di manutenzione se paragonata alle lampade a scarica.
- Prezzo competitivo rispetto all'illuminazione LED.

A indução eletromagnética é a fonte de luz ideal para a iluminação de grandes áreas.

- Acendimento imediato e compatível com sensores crepusculares ou de presença.
- Alta eficiência luminosa (>80 lm/W).
- Lámpada de longa vida útil (>100 000h) que permite reduzir os custos de manutenção comparativamente às lâmpadas de descarga.
- Preço competitivo comparativamente à iluminação LED.

Индукция — это источник света, пригодный для освещения больших площадей.

- Мгновенное зажигание и совместимость с сумеречными датчиками или датчиками присутствия.
- Высокая светотдача (> 80 лм/Вт).
- Лампа с долговечным сроком службы (> 100 000 ч), что позволяет снизить затраты на техническое обслуживание по сравнению с газоразрядными лампами.
- Конкурентная цена по сравнению со светодиодным освещением.

Indukcja jest odpowiednim źródłem światła dla oświetlenia dużych powierzchni.

- Natychmiastowe zapalenie i kompatybilne z czujnikami zapadania zmierzchu lub obecności.
- Wysoka wydajność świetlna (>80 lm/W).
- Lampy o długim okresie eksploatacji (>100.000h), pozwalające na zmniejszenie kosztów utrzymania w porównaniu z lampami wyładowcowymi.
- Konkurencyjna cena w porównaniu z oświetleniem ledowym.



HIGH EFFICIENCY BAY LIGHT

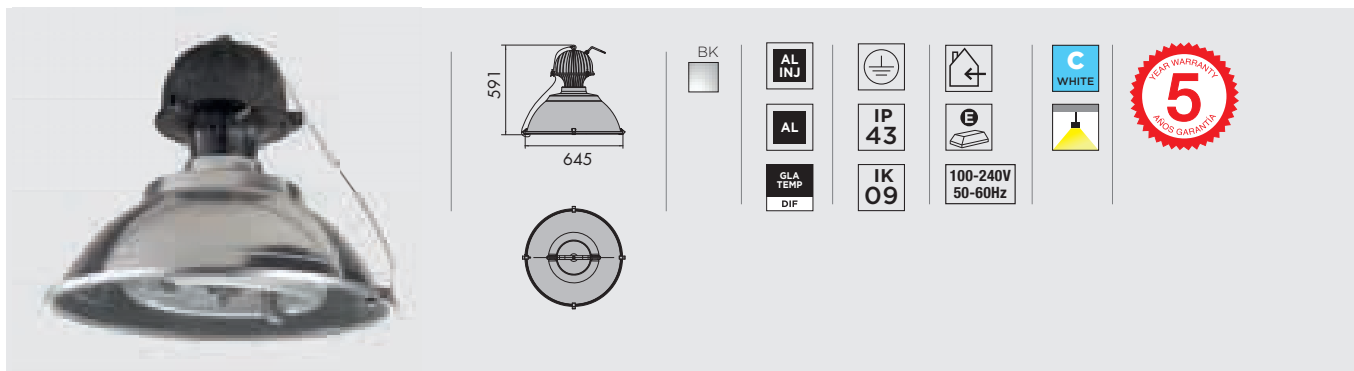

INDUCTION

 INCLUDED	80-1503-BK-37^(S)	<input type="checkbox"/>	Cold W 5000K	150W
	80-1481-BK-37^(S)	<input type="checkbox"/>		250W
	80-1413-BK-37^(S)	<input type="checkbox"/>		300W

Disponibile bajo pedido en otras temperaturas de color.
 Available on order in other colour temperatures.
 Disponible sur commande dans d'autres températures de couleur.
 Auf Anfrage auch mit anderen Farbtemperaturen lieferbar.
 Disponibile su richiesta in altre temperature di colore.
 Disponivel noutras temperaturas de cor, mediante pedido.
 На заказ поставляется других оттенков света
 Dostępny na zamówienie w innych temperaturach koloru.

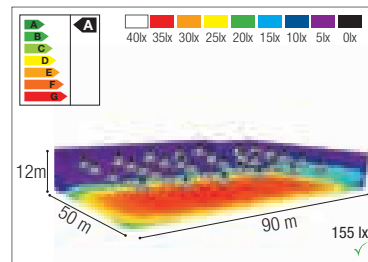
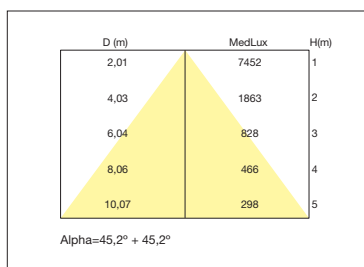
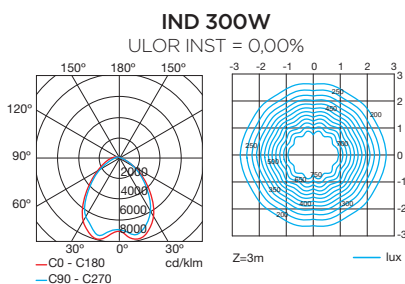

HIGH UNIFORMITY BAY LIGHT

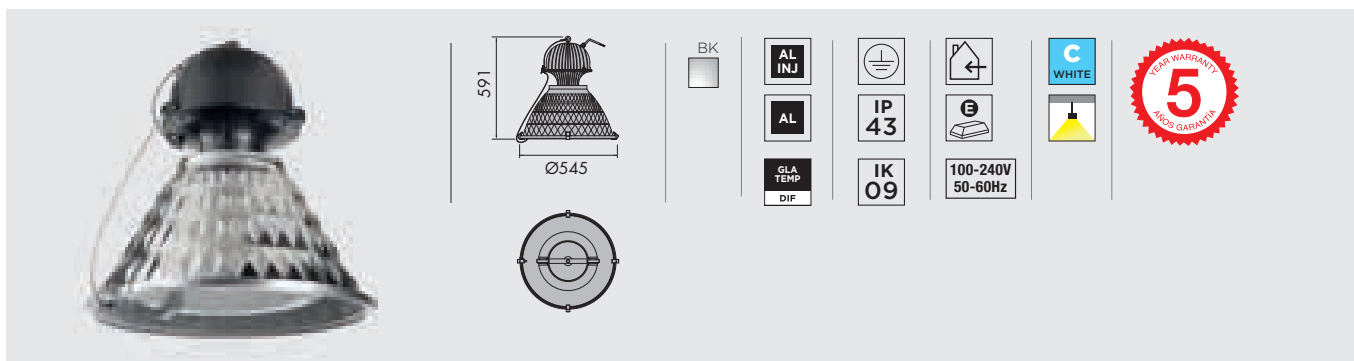

INDUCTION

 INCLUDED	80-1505-BK-37^(S)	<input type="checkbox"/>	Cold W 5000K	150W
	80-1504-BK-37^(S)	<input type="checkbox"/>		250W
	80-1414-BK-37^(S)	<input type="checkbox"/>		300W

Disponibile bajo pedido en otras temperaturas de color.
 Available on order in other colour temperatures.
 Disponible sur commande dans d'autres températures de couleur.
 Auf Anfrage auch mit anderen Farbtemperaturen lieferbar.
 Disponibile su richiesta in altre temperature di colore.
 Disponivel noutras temperaturas de cor, mediante pedido.
 На заказ поставляется других оттенков света
 Dostępny na zamówienie w innych temperaturach koloru.

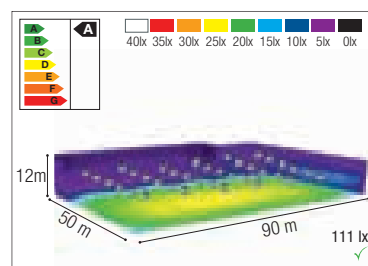
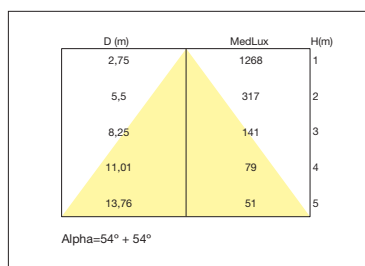
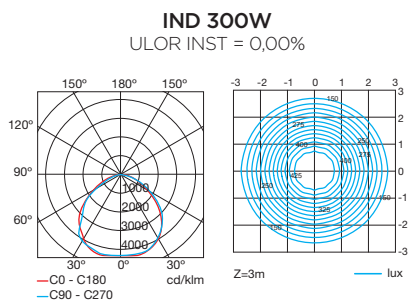

TECHNICAL



Pag. 195

Pag. 194

Pag. 195

	Ø 31-40mm	■	■	■
	Ø 41-50mm			
	Ø 51-60mm			
	Ø 61-70mm			
	Ø 91-100mm			
	51-60mm x 101-110mm			
	LED	Max. 2,3W	Max. 2,2W	Max. 2,2W
		■		■
		■	■	
	15°	■		
	25°	■		
	40°	■		
	HALO		■	■
	S4-S2			
	S2	■		
	N3		■	■
	IP20	■		
	IP23			
	IP50		■	
	IP54			■
	IP66			
	IK02			■
	IK03	■		
	IK09			



SIGNAL
 SEÑALIZACIÓN
 SIGNALISATION
 SIGNALISIERUNG
 SEGNALETICA
 SINALIZAÇÃO
 МАРКЕРНАЯ ПОДСВЕТКА
 SYGNALIZACJA



Pag. 192

Pag. 190

Pag. 194

■		
	■	
■		
		■
	■	
Max. 6,6W	Max. 4,6W	2,2W
■	■	
■		■
■	■	
	■	
		■
	■	
■		
■		
■	■	
		■
		■
		■



54-S2

AL

PMMA

DIF

IP 23

20° 20°

max. 700mA

1 Led

Dimming

150

15°

140 lm^(R)

W WHITE

CREE Led



LED



90-3489-54-S2



Warm W
3000K

max. 2,3W



LED Blanco cálido / Warm white 700mA 15°

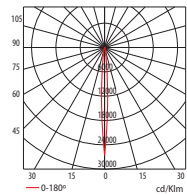

D(m)	MedLux
0.11	2119
0.23	530
0.34	235
0.46	132



x 1 x 1

Set ópticas incluidas.
Set of lenses included.
Set de lentilles fourni.
Linsenset inklusiv.
Set di lenti incluso.
Conjunto de lentes incluido
Включен набор оптических аксессуаров
Łącznie z kompletem układu optycznego

54-S2

AL

PMMA

DIF

IP 23

20° 20°

max. 700mA

2 Led

Dimming

100

15°

280 lm^(R)

W WHITE

CREE Led



LED



90-3490-54-S2



Warm W
3000K

max. 4,6W



LED Blanco cálido / Warm white 700mA 15°

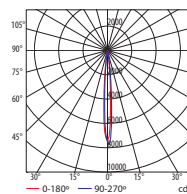

D(m)	MedLux
0.15	4899
0.29	1225
0.44	544
0.59	306



x 2 x 2

Set ópticas incluidas.
Set of lenses included.
Set de lentilles fourni.
Linsenset inklusiv.
Set di lenti incluso.
Conjunto de lentes incluido
Включен набор оптических аксессуаров
Łącznie z kompletem układu optycznego



LEO

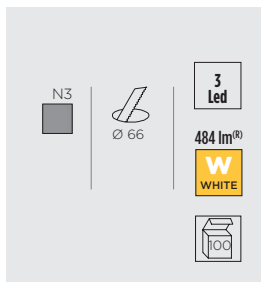
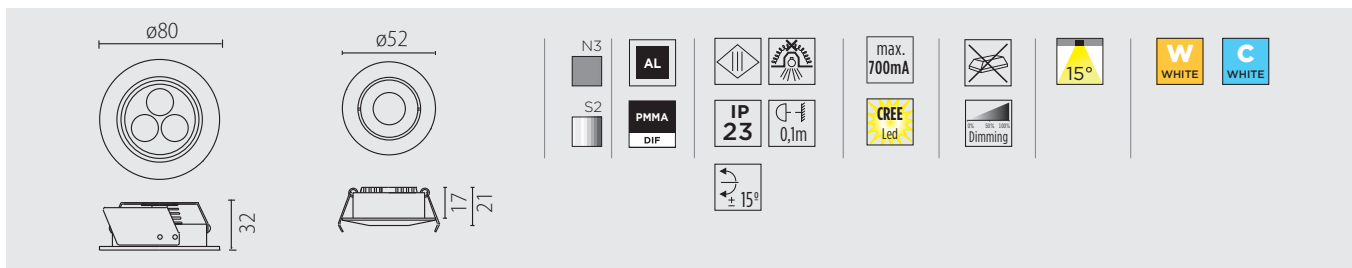

LED

	DN-0512-N3-00		Warm W 3000K	max. 6,6W	
--	----------------------	--	-----------------	-----------	--

LED Blanco cálido / Warm white 700mA

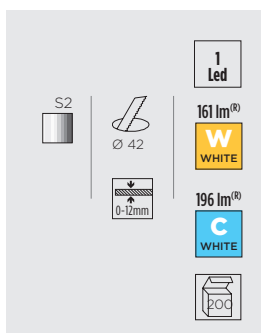
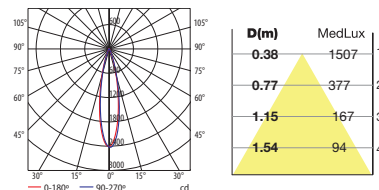

LED

	DN-0511-S2-00		Warm W 3000K	max. 2,2W	
	DN-0472-S2-00		Cold W 6000K		

LED Blanco cálido / Warm white 700mA

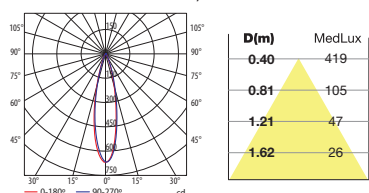

LED Blanco frío / Cold white 700mA

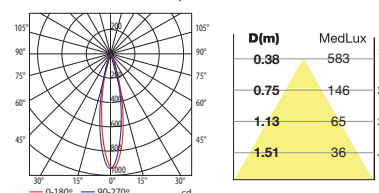

LEO

135
ø91

AL
GLA
DIF

IP 66 IK 09 RF 850°C

0,1m

CREE Led
1 Led

100-240 VAC

196 lm^(R)
C WHITE



LED



EP-0506-00-B9

Cold W 6000K

2,2W



LED Blanco frío / Cold white

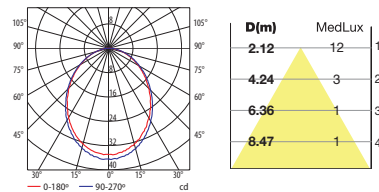

LEO

42
42
51
ø34

ø42
51
ø34

ø 35

N3

AL

IP 50 RF 850°C

0,1m

max. 700mA

1 Led

Dimming

100

196 lm^(R)
C WHITE

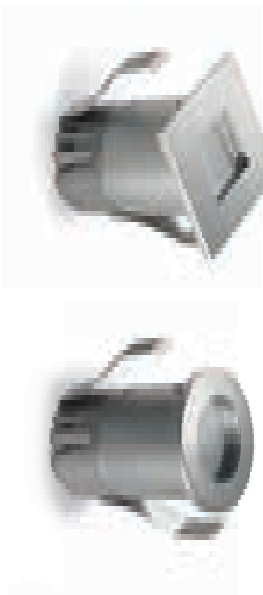

LED



DN-0289-N3-00

Cold W 6000K

max. 2,2W



LED



DN-0290-N3-00

Cold W 6000K

max. 2,2W



Accesorios /
Accessories /
Accessoires /
Zubehöre /
Accessori /
Acessórios /
Аксессуары /
Akcesoria /

Filtros de color - consultar.
Colour filters - upon request
Filtres à couleur - veuillez consulter.
Farbfilter - Auf Anfrage.
Filtri colorati - su richiesta.
Filtros de cor - Consultar
Цветных фильтров - проконсультироваться
Kolorowych filtrów - Proszę skonsultować się

DN-0289 Blanco frío / Cold white

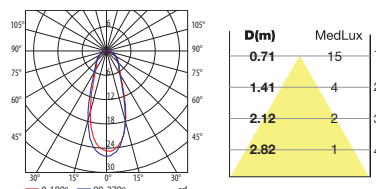

DN-0290 Blanco frío / Cold white

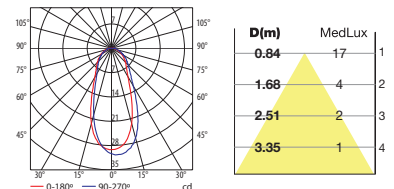

DOT



LED

	05-3314-N3-B9		Warm W 3000K	max. 2,2W	
--	----------------------	--	--------------	-----------	--

LED Blanco cálido / Warm white 700mA

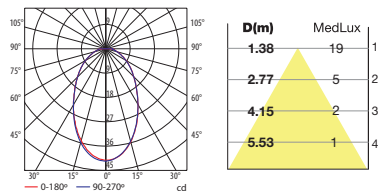

Accesorios / Accessories / Accessoires / Zubehöre / Accessori / Acessórios / Аксессуары / Аксесориа

71-4661-N3-N3	Kit
----------------------	-----

BIT



LED

	05-3308-S2-00		Warm W 3000K	max. 2,3W	
	05-3307-S2-00		Cold W 6000K		

LED Blanco cálido / Warm white 700mA 15°

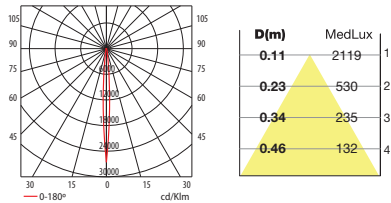

Set ópticas incluidas.
 Set of lenses included.
 Set de lentilles fourni.
 Linsenset inklusiv.
 Set di lenti incluso.
 Conjunto de lentes incluido
 Включен набор оптических аксессуаров
 Łącznie z kompletem układu optycznego

x 1
 x 1

TECHNICAL



	Ø 31-40mm	■		
	Ø 51-60mm		■	
	71-80mm x 71-80mm			■
	101-110mm x 101-110mm			
	161-170mm x 81-90mm			
	171-180mm x 141-150mm			
	171-180mm x 231-240mm			
	581-590mm x 101-110mm			
		■	■	
QR-CBC51/GU5.3	50W			■
HALOPIN G9	25W			■
QT-DE/R7S	150W			
TC-DEL/GX24Q	18W			
TL5/G5	24W			
MR16/GU5.3				■
LED		2W	2W	MAX. 2,2W
		■	■	■
				■
		■	■	■
		■	■	■
IP20		■	■	■
IP43				■



WALL FIXTURES

APLIQUES
APPLIQUES
WANDLEUCHTEN
APPLIQUE
НАСТЕННЫЕ
KINKIETY



■		
■		
■		
	■	
	■	
	■	■
	■	
	■	
	■	
MAX. 1W	4,3 / 5,9 / 8,2W	
■		
		■
■		
	■	■
■	■	■



DISK

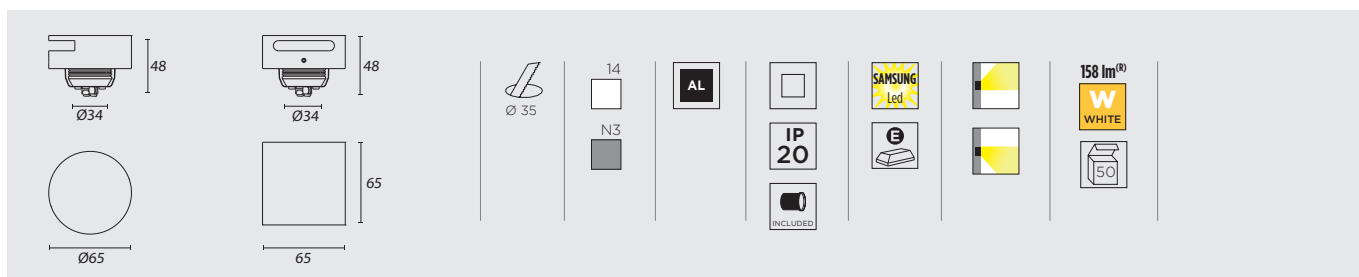

LED

	05-1613-14-00	<input type="checkbox"/>	Warm W 3000K	2W	<table border="1"> <tr><td>220V</td></tr> <tr><td>240V</td></tr> <tr><td>100V</td></tr> <tr><td>120V</td></tr> </table>	220V	240V	100V	120V	
	220V									
	240V									
	100V									
120V										
05-1613-N3-00	<input type="checkbox"/>									
05-1709-14-00	<input type="checkbox"/>									
05-1709-N3-00	<input type="checkbox"/>									

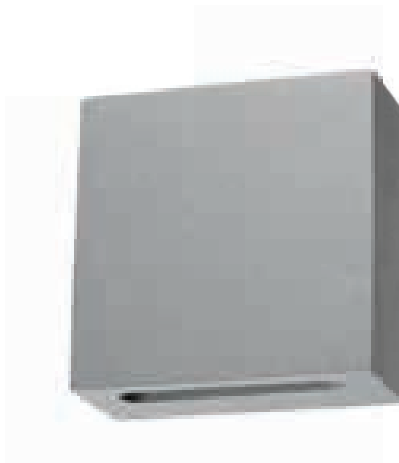

LED

	05-1618-14-00	<input type="checkbox"/>	Warm W 3000K	2W	<table border="1"> <tr><td>220V</td></tr> <tr><td>240V</td></tr> <tr><td>100V</td></tr> <tr><td>120V</td></tr> </table>	220V	240V	100V	120V	
	220V									
	240V									
	100V									
120V										
05-1618-N3-00	<input type="checkbox"/>									
05-1719-14-00	<input type="checkbox"/>									
05-1719-N3-00	<input type="checkbox"/>									



STEP

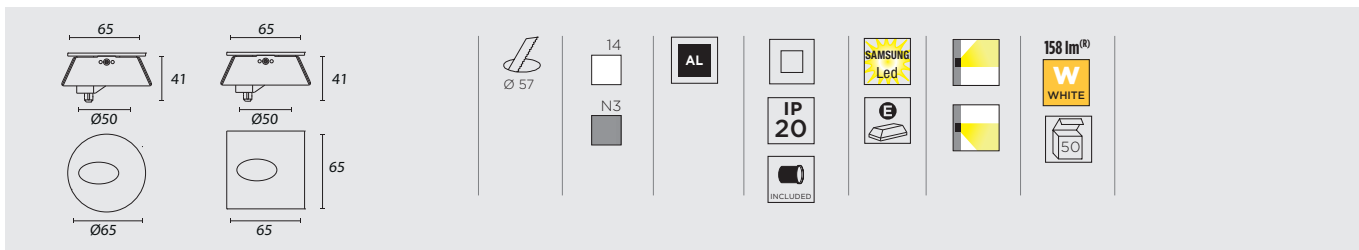

LED

	55-1573-14-00	<input type="checkbox"/>	Warm W 3000K	2W	220V 240V 100V 120V
	55-1573-N3-00	<input type="checkbox"/>			
	55-1699-14-00	<input type="checkbox"/>			
	55-1699-N3-00	<input type="checkbox"/>			



LED

	55-1574-14-00	<input type="checkbox"/>	Warm W 3000K	2W	220V 240V 100V 120V
	55-1574-N3-00	<input type="checkbox"/>			
	55-1701-14-00	<input type="checkbox"/>			
	55-1701-N3-00	<input type="checkbox"/>			



SECRET



LED

175 x 145

05-1808-14-00

 Warm W
3000K

max. 1W

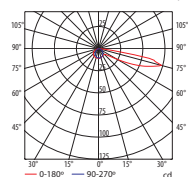
LED Blanco cálido / Warm white - 350mA

LED

170 x 85

05-1804-14-00

 Warm W
3000K

max. 1W

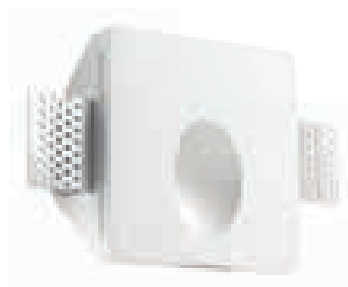
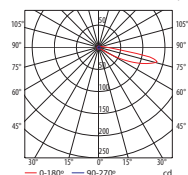
LED Blanco cálido / Warm white - 350mA

LED

105 x 105

NEW
05-2904-14-00

 Warm W
3000K

max. 1W





SIGN

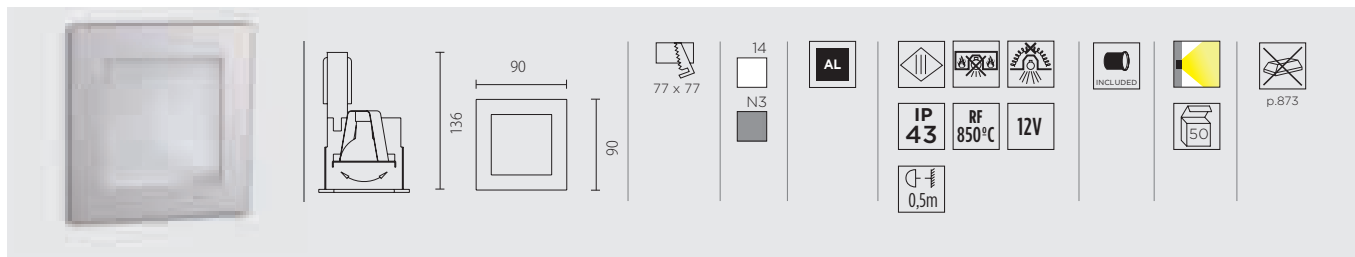

QR-CBC51 / MR16

GU5.3



EP-0348-N3-XY		max.50W		-
EP-0348-14-XY				

QR-CBC51 GU5.3 50W

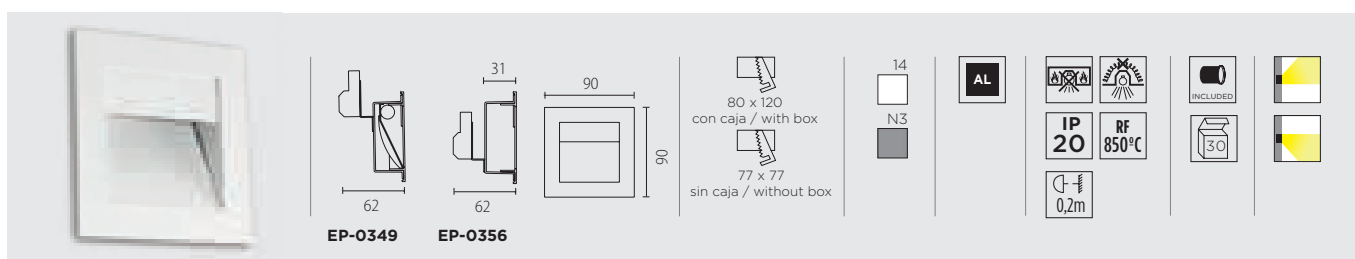
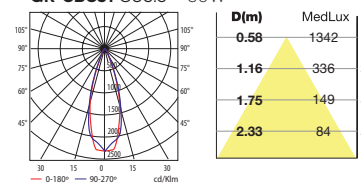

EP-0349 EP-0356

Halopin

G9



EP-0349-N3-XY		25W	-	-
EP-0349-14-XY				

HALOPIN G9

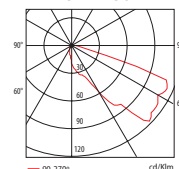

LED



max. 700mA
46 lm^(R)
W WHITE

1 Led

EP-0356-N3-00		Warm W 3000K	max. 2,2W	
EP-0356-14-00				

LED Blanco cálido / Warm white 700mA

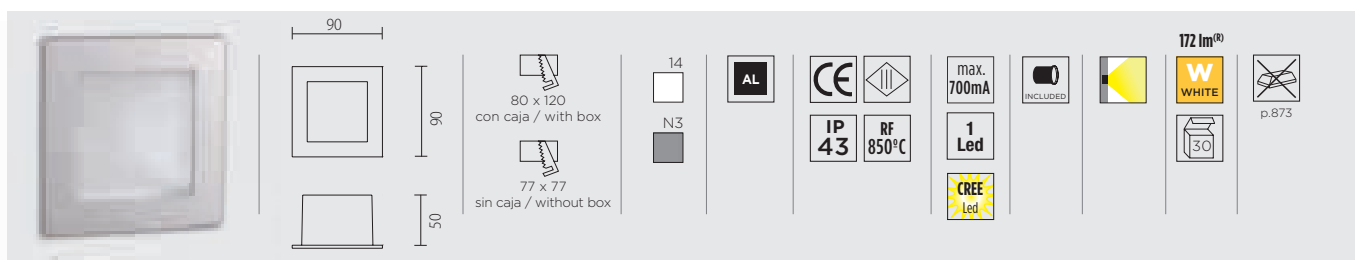
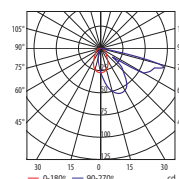

LED



NEW

05-2900-N3-XY		Warm W 3000K	max. 2,2W	
EP-1665-14-XY				

LED Blanco cálido / Warm white 700mA

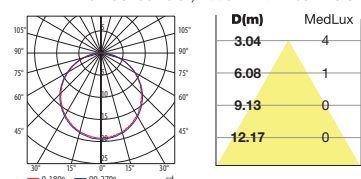

Accesorios / Accessories / Accessoires / Zubehöre / Accessori / Acessórios / Аксессуары / Akcesoria

ACT-0364-00-00



ACT-0365-00-00



Unidades eléctricas / Electrical Units / Platinés électriques / Netzteide / Unità Elettriche / Unidades eléctricas / Электрооборудование / Części elektryczne

862-869



WALL

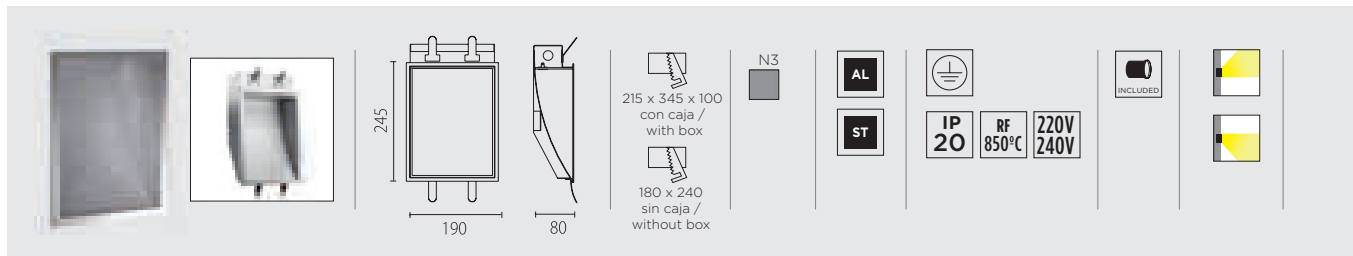

TC-DEL

GX24q-3 **EP-0344-N3-XY** 1 x 26W

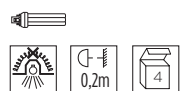

TC-TEL GX24q-3 26W opal

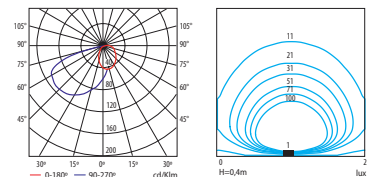

$\eta=19\%$

QT-DE

R7s **EP-0345-N3-00** max. 150W -



QT-DE R7s 100W

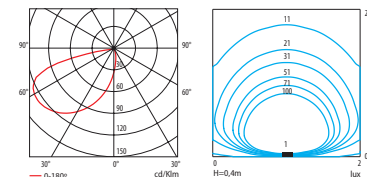

$\eta=17\%$

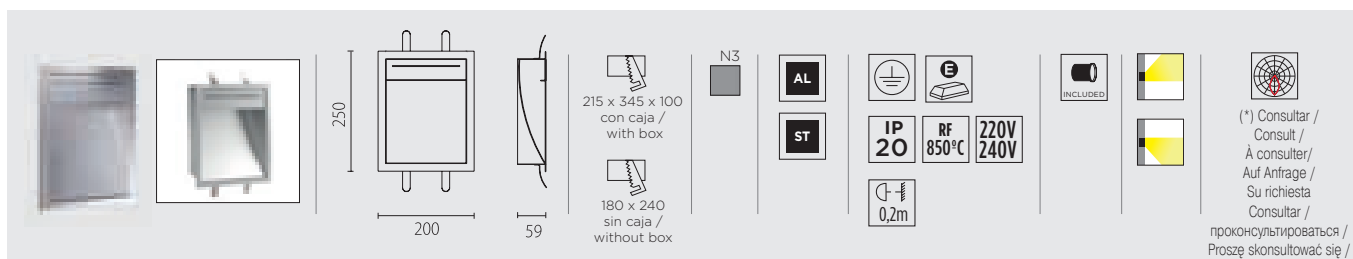

TC-DEL

GX24q-2 **EP-0346-N3-XY** 1 x 18W

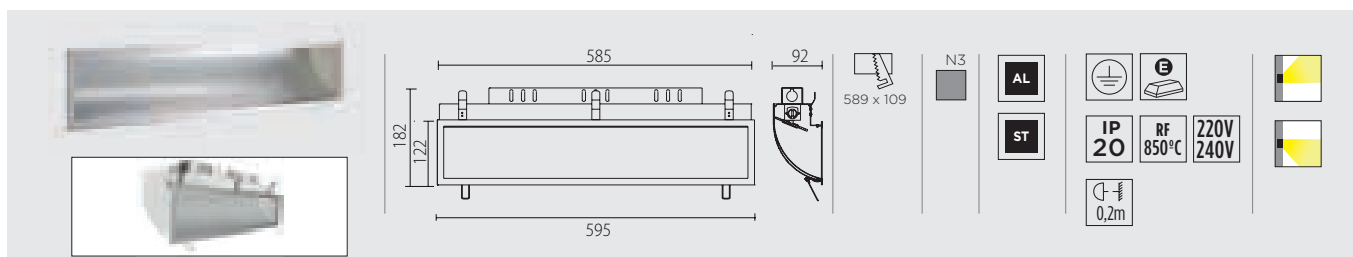

TL5

G5 **EP-0347-N3-00** 24W



TL5 G5 24W opal

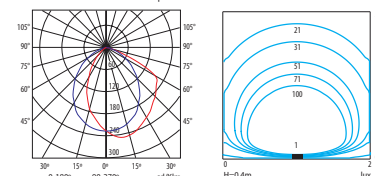

$\eta=48\%$



PIR



LED



05-4713-N3-M3 (S)	■	Neutral W 4000K	4,3W	60 cm		0-15mm	
05-4714-N3-M3 (S)	■		5,9W	90 cm		0-65mm	
05-4715-N3-M3 (S)	■		8,2W	120 cm		0-120mm	

Accesorios / Accessories / Accessoires / Zubehöre / Accessori / Acessórios / Akcesoria / Аксессуары



71-4655-N3-00 (S)	■	Kit sujeción / Attachment kit / kit de fixation / Aufhängekit / Kit di fissaggio / Kit de fixação / Набор крепежа / Zestaw mocujący
--------------------------	---	---

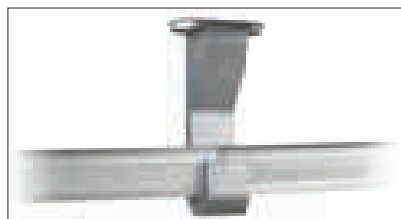

- Incorpora un sensor de infrarrojos colocado estratégicamente para que detecte la persona rápidamente. El sistema se apaga 1 minuto después de no detectar personas.
- It incorporates an infrared sensor strategically located to quickly detect the user. The system turns itself off after one minute of not detecting motion.
- Intègre un capteur à infrarouges placé stratégiquement pour détecter la personne rapidement. Le système s'éteint 1 minute après la non-détection de personnes.
- Mit strategisch platziertem Infrarotsensor zur schnellen Personenerkennung. Das Licht erlischt 1 Minute, nachdem keine Person mehr gemeldet wird.
- Contiene un sensore a infrarossi collocato in posizione strategica affinché rilevi rapidamente la presenza di una persona. Il sistema si spegne 1 minuto dopo che smette di rilevare la presenza di qualcuno.
- Incorpora um sensor de infravermelhos colocado de modo estratégico para detecção rápida das pessoas. O sistema apaga-se 1 minuto depois de não serem detectadas pessoas.
- Включает инфракрасный датчик, мгновенно реагирующий на присутствие человека. Система выключается автоматически через 1 минуту после того, как перестает фиксировать человеческое присутствие.
- Zawiera czujnik na podczerwień strategicznie umieszczony tak aby szybko wykrył osobę. System wyłącza się 1 minutę po braku wykrycia osób.

- Para medidas no estándares (60/90/120 cm) utilizar kit de sujeción. Barra con sistema anti rayado superficial.
- For non-standard measurements (60/90/120 cm), please use an attachment kit. Bar with superficial non-scratch system.
- Utiliser le kit de fixation pour les dimensions non standard (60/90/120 cm). Barre à système anti-rayure superficielle.
- Für Sondermaße (60/90/120 cm) Aufhängekit verwenden. Stange mit Anti-Kratzsystem.
- Per misure non standard (60/90/120 cm) utilizzare il kit di fissaggio. Barra con sistema anti-graffio in superficie.
- Para medidas não standard (60/90/120 cm) utilizar kit de fixação. Barra com sistema anti-riscos superficiais.
- Для нестандартных размеров (60/90/120 см) используйте набор крепежа. Светильник с системой защиты корпуса от внешних царапин.
- Dla niestandardowych wymiarów (60/90/120 cm) użyć zestawu mocującego. Pręt z systemem przeciw występowaniu zarysowań na powierzchni.

- El conjunto se puede instalar indiferentemente a la derecha o izquierda del armario.
- This kit can be installed either on the right or left side of the wardrobe.
- L'ensemble peut être installé indifféremment sur le côté gauche ou droit de la penderie.
- Bei der Konzeption wurde besonderen Wert auf eine kurze Einbauezeit gelegt. Mit Schablone als Installationshilfe.
- Il set può essere installato indifferentemente sul lato destro o sinistro dell'armadio.
- O conjunto pode instalar-se à direita ou à esquerda do guarda-fatos.
- Группу можно монтировать слева или справа от шкафа.
- Ten zespół może zostać zainstalowany obojętnie albo po prawej albo po lewej stronie szafy.

TECHNICAL

		VDC	LUZ/ LIGHT/ CBET/ ŚWIATŁO	REFERENCIA/ WREFERENCE/ АРТИКУЛ/ NR REFERENCYJNY	W/m	LEDS/m	IP	
ION	p. 212	12VDC	WARM WHITE	91-3411-54-M2	7,2		68	
			WARM WHITE	91-3408-54-M2	14,4		68	
ZENIT	p. 213	24VDC	WW-CW	91-2492-00-00	9,6	60	65	
SIGMA	p. 214	12VDC	WARM WHITE	91-3473-00-00	4,8	60	20	
RAND HP	p. 215	12VDC	WARM WHITE	91-2343-00-00	14,4	120	20	
			COLD WHITE	91-2353-00-00	14,4	120	20	
RAND IP	p. 216	12VDC	WARM WHITE	91-3420-00-00	4,8	60	65	
			COLD WHITE	91-3419-00-00	4,8	60	65	
ON	p. 217	24VDC	WARM WHITE	91-4671-00-00	4,8	60	20	
ON ECO	p. 218	24VDC	WARM WHITE	91-0150-00-00	4,8	60	20	
			RGB	91-2488-00-00	7,2	30	20	
ON HP	p. 219	24VDC	WARM WHITE	91-2361-00-00	14,4	120	20	
			WARM WHITE	91-3282-00-00	14,4	120	20	
			COLD WHITE	91-2365-00-00	14,4	120	20	
			RGB	91-2379-00-00	14,4	60	20	
ON IP ECO	p. 220	24VDC	WARM WHITE	91-0175-00-00	4,8	60	65	
			COLD WHITE	91-0171-00-00	4,8	60	65	
			RGB	91-2491-00-00	7,2	60	65	
FACADE	p. 221	24VDC	WARM WHITE	91-3227-00-00	3,6	42	68	
			RGB	91-3228-00-00	5,8	28	68	
			WARM WHITE	91-3244-00-00	3,6	42	67	
			RGB	91-3245-00-00	5,8	28	67	





LED STRIPS

TIRAS LED
 BANDEAUX À LED
 LED-BÄNDER
 STRISCE LED
 FITAS LED
 СВЕТОДИОДНЫЕ ЛЕНТЫ
 PASKI LED

CORTE / CUT / ШАГ СРЕЗА / PRZEKRÓJ (MM)

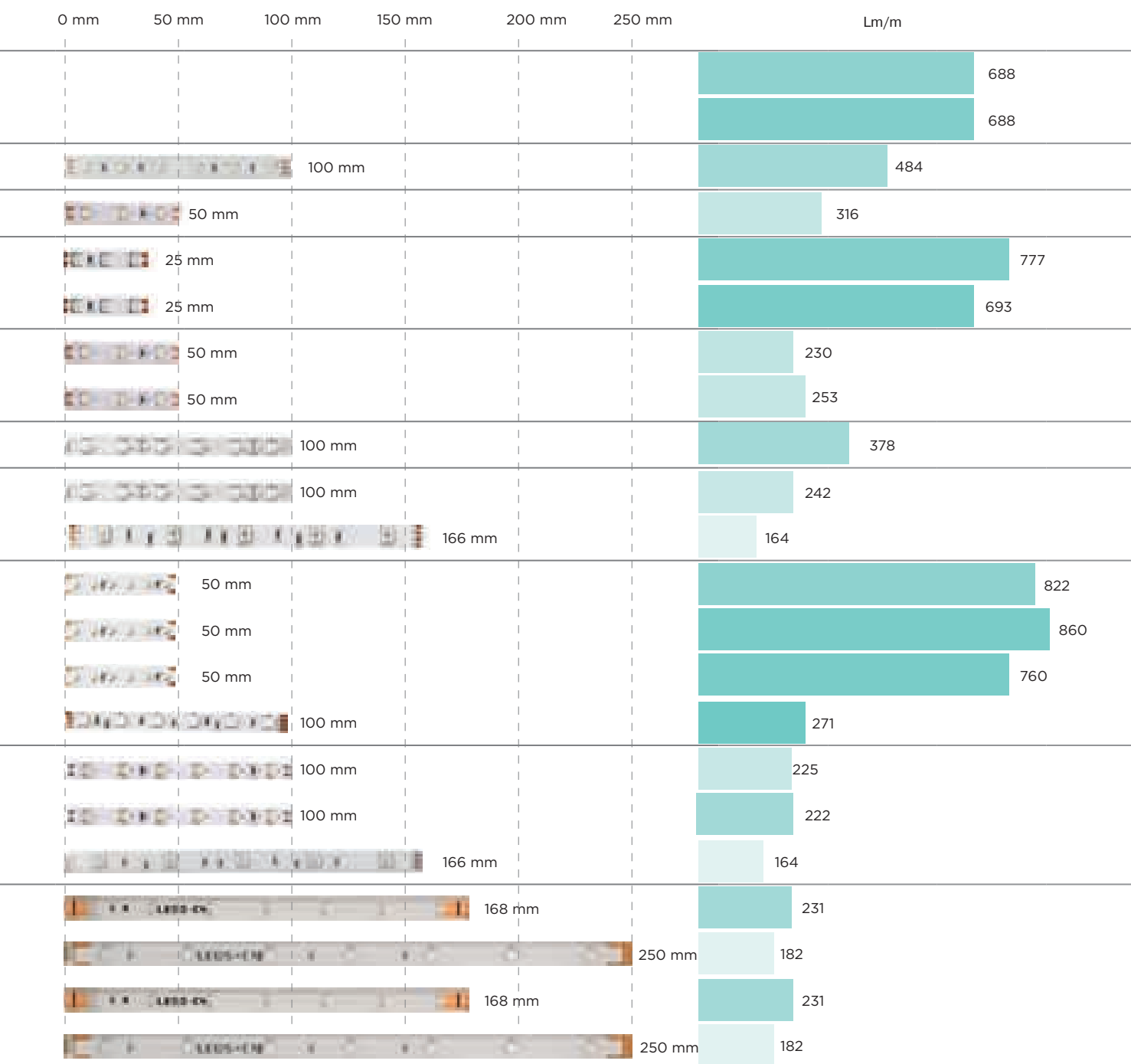

ION

54	AL	IP 68	12 VDC	0,5m 7,2W	1m 14,4W	Dimming	3m	120°	344 lm ^(R) 7,2W	684 lm ^(R) 14,4W	3 3 ANOS GARANTIA
----	----	-------	--------	--------------	-------------	---------	----	------	-------------------------------	--------------------------------	----------------------

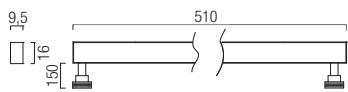

LED



91-3411-54-M2



Warm W
3000K

7,2W

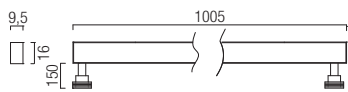

LED



91-3408-54-M2



Warm W
3000K

14,4W



91-3408 LED Blanco cálido / Warm white

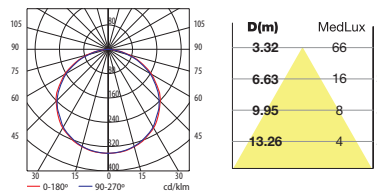

Accesorios / Accessories / Accessoires / Zubehöre / Accessori / Acessórios / Аксессуары / Akcesoria



71-3411-56-56

Accesorio para orientar la tira ION
 Accessory to adjust the ION strip
 Accessoire d'orientation du bandeau ION
 Zubehöre zur Ausrichtung von ION-Band
 Accessorio per orientare la striscia ION
 Acessório para orientar a tira ION
 Включает аксессуар для направляемости ленты ION
 Zawiera akcesorium do nastawiania oprawy ion

Consultar guías de instalación antes de realizar cualquier manipulación. / Consult installation guides before handling the product. / Consulter les guides d'installation avant toute manipulation. / Bitte lesen Sie vor der Montage die Installationsanleitungen. / Consultare la guida di installazione prima di installare il prodotto. / Consultar os guias de instalação antes de qualquer manuseamento. / До начала работы обязательно ознакомьтесь с инструкцией по монтажу / Zapoznać się z instrukcjami zamontowania przed wykonaniem jakichkolwiek czynności.

Unidades eléctricas / Electrical Units / Platines électriques / Netzteide / Unità Elettriche / Unidades elétricas / Электрооборудование / Części elektryczne	862-869
--	----------------



ZENIT

NEW

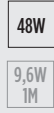
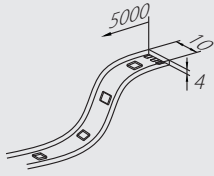

LED



50.000 h.

91-2492-00-00

3000K-6000K

48W

60 LED/m



91-2492 LED

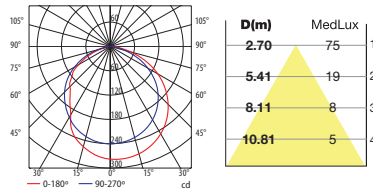

110
23
80

85
45

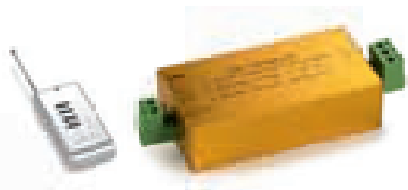

71-3467-00-00

12/24VDC 120/240W

Controlador / Controller / Contrôleur / Steuergerät /
Regolatori / Controlador / Контроллер / Kontroler

90
23
60

42
42



71-3468-00-00

12/24VDC 120/240W

Amplificador / Amplifier / Amplificateur / Verstärker /
Amplificatore / Amplificador / Усилитель / Wzmacniacz

Accesorios / Accessories / Accessoires / Zubehöre / Accessori / Acessórios / Аксессуары / Akcesoria

LINEAL

Perfil de 2m / 2 m Profile / Profil de 2 m / 2 M Profil / Profili di 2 m / Calha de 2 m / Профиль 2 м / Profil 2m
ver pag. / see page / voir page / siehe Seite / vedi pag. / ver página / Смотреть страницу / Zobacz stronę . 223

Consultar guías de instalación antes de realizar cualquier manipulación. / Consult installation guides before handling the product. / Consulter les guides d'installation avant toute manipulation. / Bitte lesen Sie vor der Montage die Installationsanleitungen. / Consultare la guida di installazione prima di installare il prodotto. / Consultar os guias de instalação antes de qualquer manuseamento. / До начала работы обязательно ознакомьтесь с инструкцией по монтажу / Zapoznać się z instrukcjami zamontowania przed wykonaniem jakichkolwiek czynności.

Unidades eléctricas / Electrical Units / Platines électriques / Netzteide / Unità Elettriche / Unidades
elétricas / Электрооборудование / Części elektryczne

862-869

SIGMA

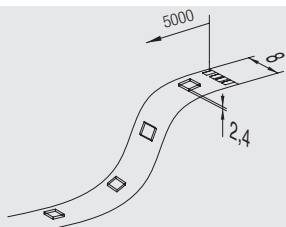

	24W			120°	1581 lm⁹⁰	
IP 20	4,8W 1M		10m		W WHITE	
12 VDC						



LED



50.000 h.

91-3473-00-00

Warm W 3000K

24W

60 LED/m



91-3473 LED
Blanco cálido / Warm white

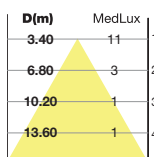
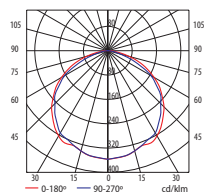

Accesorios / Accessories / Accessoires / Zubehöre / Accessori / Acessórios / Аксессуары / Akcesoria

LINEAL

Perfil de 2m / 2 m Profile / Profil de 2 m / 2 M Profil / Profili di 2 m / Calha de 2 m / Профиль 2 м / Profil 2m
ver pág. / see page / voir page / siehe Seite / vedi pag. / ver página / Смотреть страницу / Zobacz stronę . 223

Consultar guías de instalación antes de realizar cualquier manipulación. / Consult installation guides before handling the product. / Consulter les guides d'installation avant toute manipulation. / Bitte lesen Sie vor der Montage die Installationsanleitungen. / Consultare la guida di installazione prima di installare il prodotto. / Consultar os guias de instalação antes de qualquer manuseamento. / До начала работы обязательно ознакомьтесь с инструкцией по монтажу / Zapoznać się z instrukcjami zamontowania przed wykonaniem jakichkolwiek czynności.

Unidades eléctricas / Electrical Units / Platines électriques / Netzteide / Unità Elettriche / Unidades elétricas / Электрооборудование / Części elektryczne

862-869



RAND HIGH POWER

NEW

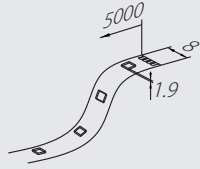

72W

3885 lm⁽⁹⁾ 3467 lm⁽⁹⁾

W WHITE C WHITE



IP 20

14,4W 1M



5m



12 VDC



LED



50.000 h.

91-2343-00-00

Warm W 3000K

72W

120 LED/m



91-2353-00-00

Cold W 6000K

91-2343 LED

Blanco cálido / Warm white

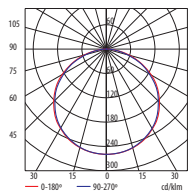

91-2353 LED

Blanco frío / Cold white

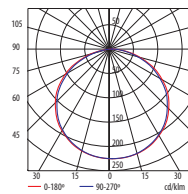

Accesorios / Accessories / Accessoires / Zubehöre / Accessori / Acessórios / Аксессуары / Akcesoria

LINEAL

Perfil de 2m / 2m Profile / Profil de 2m / 2M Profil / Profili di 2m / Calha de 2m / Профиль 2м / Profil 2m
ver pág. / see page / voir page / siehe Seite / vedi pag. / ver página / Смотреть страницу / Zobacz stronę . 223

Consultar guías de instalación antes de realizar cualquier manipulación. / Consult installation guides before handling the product. / Consulter les guides d'installation avant toute manipulation. / Bitte lesen Sie vor der Montage die Installationsanleitungen. / Consultare la guida di installazione prima di installare il prodotto. / Consultar os guias de instalação antes de qualquer manuseamento. / До начала работы обязательно ознакомьтесь с инструкцией по монтажу / Zapoznać się z instrukcjami zamontowania przed wykonaniem jakichkolwiek czynności.

Unidades eléctricas / Electrical Units / Platines électriques / Netzteide / Unitá Elettriche / Unidades eléctricas / Электрооборудование / Części elektryczne

862-869

RAND IP

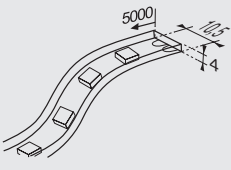



LED



50.000 h.

91-3420-00-00	Warm W 3000K	24W	60 LED/m	
91-3419-00-00	Cold W 6000K			

91-3420 LED
Blanco cálido / Warm white

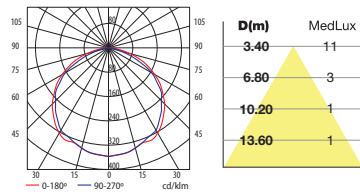

91-3419 LED
Blanco frío / Cold white

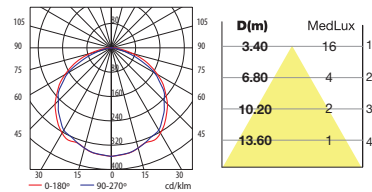

Accesorios / Accessories / Accessoires / Zubehöre / Accessori / Acessórios / Аксессуары / Akcesoria

LINEAL

Perfil de 2m / 2m Profile / Profil de 2m / 2 M Profil / Profili di 2m / Calha de 2m / Профиль 2м / Profil 2m
ver pág. / see page / voir page / siehe Seite / vedi pag. / ver página / Смотреть страницу / Zobacz stronę . 223

Consultar guías de instalación antes de realizar cualquier manipulación. / Consult installation guides before handling the product. / Consulter les guides d'installation avant toute manipulation. / Bitte lesen Sie vor der Montage die Installationsanleitungen. / Consultare la guida di installazione prima di installare il prodotto. / Consultar os guias de instalação antes de qualquer manuseamento. / До начала работы обязательно ознакомьтесь с инструкцией по монтажу / Zapoznać się z instrukcjami zamontowania przed wykonaniem jakichkolwiek czynności.

Unidades eléctricas / Electrical Units / Platines électriques / Netzteide / Unità Elettriche / Unidades elétricas / Электрооборудование / Części elektryczne

862-869



ON

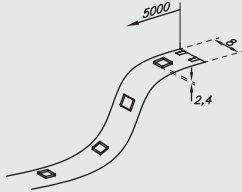

	24W			120°	1890 lm[®]	
IP 20	4,8W 1M		20m XXXX-XXXX		W WHITE	
24 VDC						

**LED**

50.000 h.

91-4671-00-00

Warm W 3000K

24W

60 LED/m



91-4671 LED
Blanco cálido / Warm white

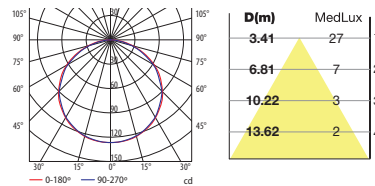

Accesorios / Accessories / Accessoires / Zubehöre / Accessori / Acessórios / Аксессуары / Akcesoria

LINEAL

Perfil de 2m / 2 m Profile / Profil de 2 m / 2 M Profil / Profili di 2 m / Calha de 2 m / Профиль 2 м / Profil 2m
ver pág. / see page / voir page / siehe Seite / vedi pag. / ver página / Смотреть страницу / Zobacz stronę . 223

Consultar guías de instalación antes de realizar cualquier manipulación. / Consult installation guides before handling the product. / Consulter les guides d'installation avant toute manipulation. / Bitte lesen Sie vor der Montage die Installationsanleitungen. / Consultare la guida di installazione prima di installare il prodotto. / Consultar os guias de instalação antes de qualquer manuseamento. / До начала работы обязательно ознакомьтесь с инструкцией по монтажу / Zapoznać się z instrukcjami zamontowania przed wykonaniem jakichkolwiek czynności.

Unidades eléctricas / Electrical Units / Platines eléctricos / Netzteide / Unità Elettriche / Unidades
elétricas / Электрооборудование / Części elektryczne

862-869

ON ECO

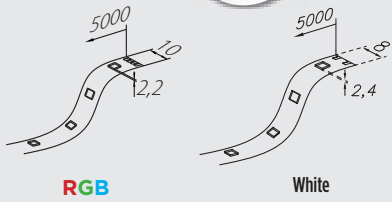

	RGB 36W 5M	Warm 24W 5M			820 lm ^(R) RGB LIGHT	1210 lm ^(R) W WHITE	
IP 20	7,2W 1M	4,8W 1M					
24 VDC			RGB 10m +++++ +++++	White 20m +++++ +++++			



LED Eco

28.000 h.

NEW	91-2488-00-00	RGB	36W	30 LED/m	
	91-0150-00-00	Warm W 3000K	24W	60 LED/m	

91-2488-00-00 LED
RGB

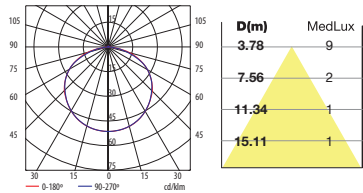

91-0150-00-00 LED
Blanco cálido / Warm white

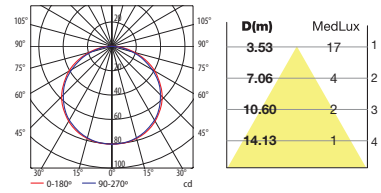

Accesorios / Accessories / Accessoires / Zubehöre / Accessori / Acessórios / Аксессуары / Akcesoria

LINEAL

Perfil de 2m / 2m Profile / Profil de 2m / 2M Profil / Profili di 2m / Calha de 2m / Профиль 2м / Profil 2m
ver pág. / see page / voir page / siehe Seite / vedi pag. / ver página / Смотреть страницу / Zobacz stronę . 223

Consultar guías de instalación antes de realizar cualquier manipulación. / Consult installation guides before handling the product. / Consulter les guides d'installation avant toute manipulation. / Bitte lesen Sie vor der Montage die Installationsanleitungen. / Consultare la guida di installazione prima di installare il prodotto. / Consultar os guias de instalação antes de qualquer manuseamento. / До начала работы обязательно ознакомьтесь с инструкцией по монтажу / Zapoznać się z instrukcjami zamontowania przed wykonaniem jakichkolwiek czynności.

Unidades eléctricas / Electrical Units / Platines électriques / Netzteide / Unità Elettriche / Unidades elétricas / Электрооборудование / Części elektryczne	862-869
--	----------------



ON HIGH POWER

NEW

	72W 5M				1358 lm ^(R)	4109 lm ^(R)	3800 lm ^(R)	
IP 20	14,4W 1M				RGB LIGHT	W WHITE	C WHITE	
24 VDC						3000K		
						4300 lm ^(R)	W WHITE	
							2500K	



LED



50.000 h.

91-2379-00-00	RGB	72W	60 LED/m	
91-3282-00-00	Warm W 2500K		120 LED/m	
91-2361-00-00	Warm W 3000K			
91-2365-00-00	Cold W 6000K			

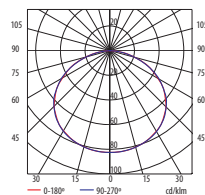
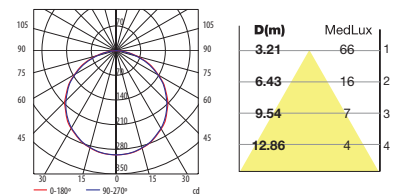
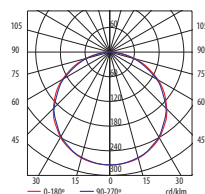
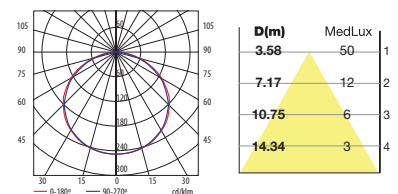
91-2379-00-00 LED
RGB**91-3282-00-00** LED
Blanco cálido / Warm white**91-2361-00-00** LED
Blanco cálido / Warm white**91-2365-00-00** LED
Blanco frío / Cold white

Accesorios / Accessories / Accessoires / Zubehöre / Accessori / Acessórios / Аксессуары / Akcesoria

LINEAL

Perfil de 2m / 2 m Profile / Profil de 2 m / 2 M Profil / Profili di 2 m / Calha de 2 m / Профиль 2 м / Profil 2m
ver pág. / see page / voir page / siehe Seite / vedi pag. / ver página / Смотреть страницу / Zobacz stronę 223

Consultar guías de instalación antes de realizar cualquier manipulación. / Consult installation guides before handling the product. / Consulter les guides d'installation avant toute manipulation. / Bitte lesen Sie vor der Montage die Installationsanleitungen. / Consultare la guida di installazione prima di installare il prodotto. / Consultar os guias de instalação antes de qualquer manuseamento. / До начала работы обязательно ознакомьтесь с инструкцией по монтажу / Zapoznać się z instrukcjami zamontowania przed wykonaniem jakichkolwiek czynności.

Unidades eléctricas / Electrical Units / Platines électriques / Netzteide / Unità Elettriche / Unidades
eléctricas / Электрооборудование / Części elektryczne

862-869

ON IP ECO

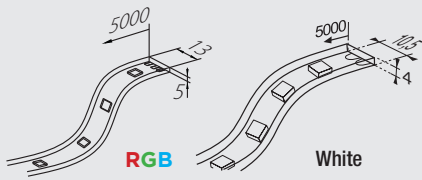

IP 65 RF 850°C
24 VDC

RGB Blanco W hite
36W 5M 24W 5M
7,2W 1M 4,8W 1M
Dimming
RGB White
10m 20m

120°
820 lm^(R) 1127 lm^(R) 1111 lm^(R)
RGB LIGHT W WHITE C WHITE



LED Eco



28.000 h.

NEW

91-2491-00-00	RGB	36W	60LED/m	
91-0175-00-00	Warm W 3000K	24W		
91-0171-00-00	Cold W 6000K			

91-2491-00-00 LED RGB

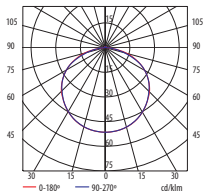

91-0175-00-00 LED Blanco cálido / Warm white

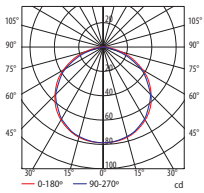

91-0171-00-00 LED Blanco frío / Cold white

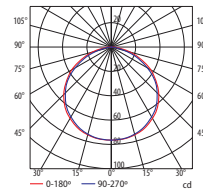

Accesorios / Accessories / Accessoires / Zubehöre / Accessori / Acessórios / Аксессуары / Akcesoria

LINEAL

Perfil de 2m / 2 m Profile / Profil de 2 m / 2 M Profil / Profili di 2 m / Calha de 2 m / Профиль 2 м / Profil 2m
ver pág. / see page / voir page / siehe Seite / vedi pag. / ver página / Смотреть страницу / Zobacz stronę . 223

Consultar guías de instalación antes de realizar cualquier manipulación. / Consult installation guides before handling the product. / Consulter les guides d'installation avant toute manipulation. / Bitte lesen Sie vor der Montage die Installationsanleitungen. / Consultare la guida di installazione prima di installare il prodotto. / Consultar os guias de instalação antes de qualquer manuseamento. / До начала работы обязательно ознакомьтесь с инструкцией по монтажу / Zapoznać się z instrukcjami zamontowania przed wykonaniem jakichkolwiek czynności.

Unidades eléctricas / Electrical Units / Platines électriques / Netzteide / Unità Elettriche / Unidades elétricas / Электрооборудование / Części elektryczne

862-869



FACADE

NEW

PUR		RGB	White			120°	1230 lm ^(R) 3465 lm ^(R)	
UVA PROTECTED	24 VDC	87W	54W			RGB LIGHT	W WHITE	
		5,8W 1M	3,6W 1M	15m				

LED



50.000 h.

**IP 67**

Permite cortar y unir / Can be cut and joined / Permet de couper et de raccorder / Zum Trennen und Verbinden / Consente di tagliare e collegare / Permite cortar e unir / Позволяет разрезать и соединять / Pozwala na przecięcie i połączenie

91-3245-00-00	RGB	87W
91-3244-00-00	Warm W 3000K	54W

71-3232-00-00	RGB	Accesorios / Accessories / Accessoires / Zubehöre / Acessórios / Accessori / Аксессуары
71-3229-00-00	WHITE	

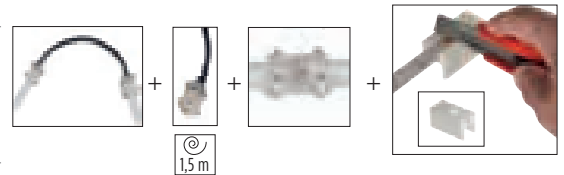
**IP 68**

Solo permite corte con tapa final. No uniones / Can only be cut with final cover. Cannot be joined / Permet uniquement la découpe avec cache final, pas de raccords. / Nur für Schnitt mit Endkappe. Keine Verbindungen / Consente soltanto un taglio con cappuccio finale. No collegamenti / Só permite o corte com tampa terminal. Não permite uniões / Позволяет только разрез с окончательным покрытием. Соединения не разрешены / Pozwala na przecięcie tylko z końcową klapą. Bez złązek

91-3228-00-00	RGB	87W
91-3227-00-00	Warm W 3000K	54W

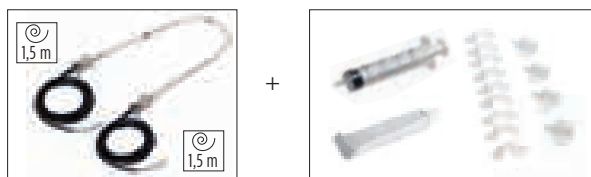

Para tira IP68 a medida, consulte con Equipo Comercial / For special IP68 strip length, please contact your sales representative. / Pour un bandeau IP68 sur mesure, veuillez consulter l'équipe commerciale. / Für IP68-Streifen nach Maß wenden Sie sich bitte an unsere Vertriebsmitarbeiter / Per striscia IP68 su misura, contattare lo staff commerciale. / Para fita IP68 à medida, consulte a Equipa Comercial / Для полосы IP68 под заказ, обратитесь, пожалуйста, в коммерческий отдел / Dla taśmy IP68 na miarę, proszę skonsultować się z działem handlowym.

Accesorios / Accessories / Accessoires / Zubehöre / Accessori / Acessórios / Аксессуары / Akcesoria

**71-4664-00-00**

Controlador / Controller / Contrôleur / Steuergerät / Regolatori / Controlador / Контроллер / Kontroler

IP 65 **24 VDC** **9A** **210W**

**71-4665-00-00**

Amplificador / Amplifier / Amplificateur / Verstärker / Amplificatore / Amplificador / Амплификатор / Wzmacniacz

IP 65 **24 VDC** **15A** **360W**

Consultar guías de instalación antes de realizar cualquier manipulación. / Consult installation guides before handling the product. / Consulter les guides d'installation avant toute manipulation. / Bitte lesen Sie vor der Montage die Installationsanleitungen. / Consultare la guida di installazione prima di installare il prodotto. / Consultar os guias de instalação antes de qualquer manuseamento. / До начала работы обязательно ознакомьтесь с инструкцией по монтажу / Zapoznać się z instrukcjami zamontowania przed wykonaniem jakichkolwiek czynności.

Unidades eléctricas / Electrical Units / Platines électriques / Netzteide / Unità Elettriche / Unidades eléctricas / Электрооборудование / Części elektryczne

862-869





LINEAL

54



Perfil de 2m
2m Profile
Profil de 2m
2 M Profil
Profili di 2m
Calha de 2m
Профиль 2 м
Profil 2m

Todos los perfiles incluyen tapas finales y clips de sujeción.
All profiles include end caps and fastening clips.
Tous les profilés comprennent des caches finaux ainsi que des clips de fixation.
Alle Profile enthalten Deckel und Befestigungsklammern.
Tutti i profili contengono cappucci finali e ganci per il fissaggio.
Todas as calhas incluem topos finais e clips de fixação
Все профили поставляются с торцевыми заглушками и крепежом.
Wszystkie profile zawierają zaślepki i zaciski mocujące



Perfil de 2m
2m Profile
Profil de 2m
2 M Profil
Profili di 2m
Calha de 2m
Профиль 2 м
Profil 2m

Perfil de 2m + Difusor transparente
2m profile + Transparent diffuser
Profil de 2m + Diffuseur transparent
2 M Profil + Transparenter Diffusor
Profilo di 2m + Diffusore trasparente
Calha de 2 m + Difusor transparente
Профиль 2 м + прозрачный
рассеиватель
Profil 2m + Przezroczysty dyfuzor

Perfil de 2m + Difusor matizado
2m profile + Matt diffuser
Profil de 2m + Diffuseur verre mat
2 M Profil + Matter Diffusor
Profilo di 2m + diffusore sfumato
Calha de 2 m + Difusor fosco
Профиль 2 м + поляризованный
рассеиватель
Profil 2m + matowy dyfuzor

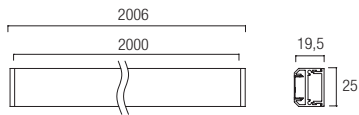

-

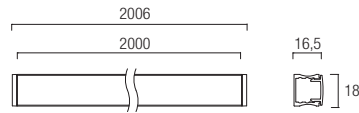
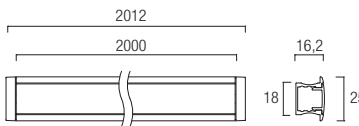
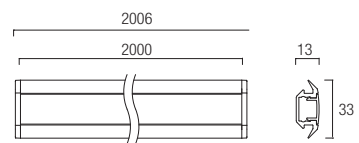
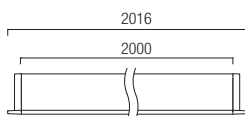
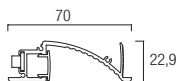
71-3454-54-M2**71-3454-54-M3****71-0289-54-00****71-0566-54-M2****71-0566-54-M3****71-0299-54-00****71-0580-54-M2****71-0580-54-M3****71-0331-54-00****71-0593-54-M2****71-0593-54-M3****71-0388-54-00****71-0594-54-M2****71-0594-54-M3****71-1554-54-00**

Kit para empotrar en pared de obra / Recessing kit for brick wall / Kit pour encastrer au mur / Kit zum Einbauen im Mauerwerk. / Kit per incasso a parete / Kit para encastrar em parede de obra / Набор для встроенного монтажа. / Zestaw do montażu w ścianach z cegły

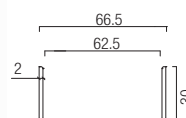



DECORATIVE

 226-271
FAMILIES

FAMILIAS
FAMILLES
FAMILIEN
FAMIGLIE
FAMÍLIAS
СЕРИИ
RODZINY

 272-341
DRESS UP

 342-393
**WALL &
CEILING**

PAREDES Y TECHOS
MUR ET PLAFOND
WAND UND DECKE
PARETE E SOFFITTO
PAREDE E TECTO
НАСТЕННЫЕ И ПОТОЛОЧНЫЕ
KINKIETY I SUFITOWE

 410-445
BATH

BAÑO
SALLE DE BAINS
BAD
BAGNO
CASA DE BANHO
ДЛЯ ВАННЫХ КОМНАТ
ŁAZIENKOWE

 394-409
**DESK
& FLOOR**



SOBREMESAS Y PIES
BUREAU ET SOL
TISCH UND STEH
SCRIVANIA E PAVIMENTO
ESCRITÓRIOS E CHÃO
НАСТОЛЬНЫЕ ЛАМПЫ И
ТОРШЕРЫ
BIURKOWE I STOJĄCE

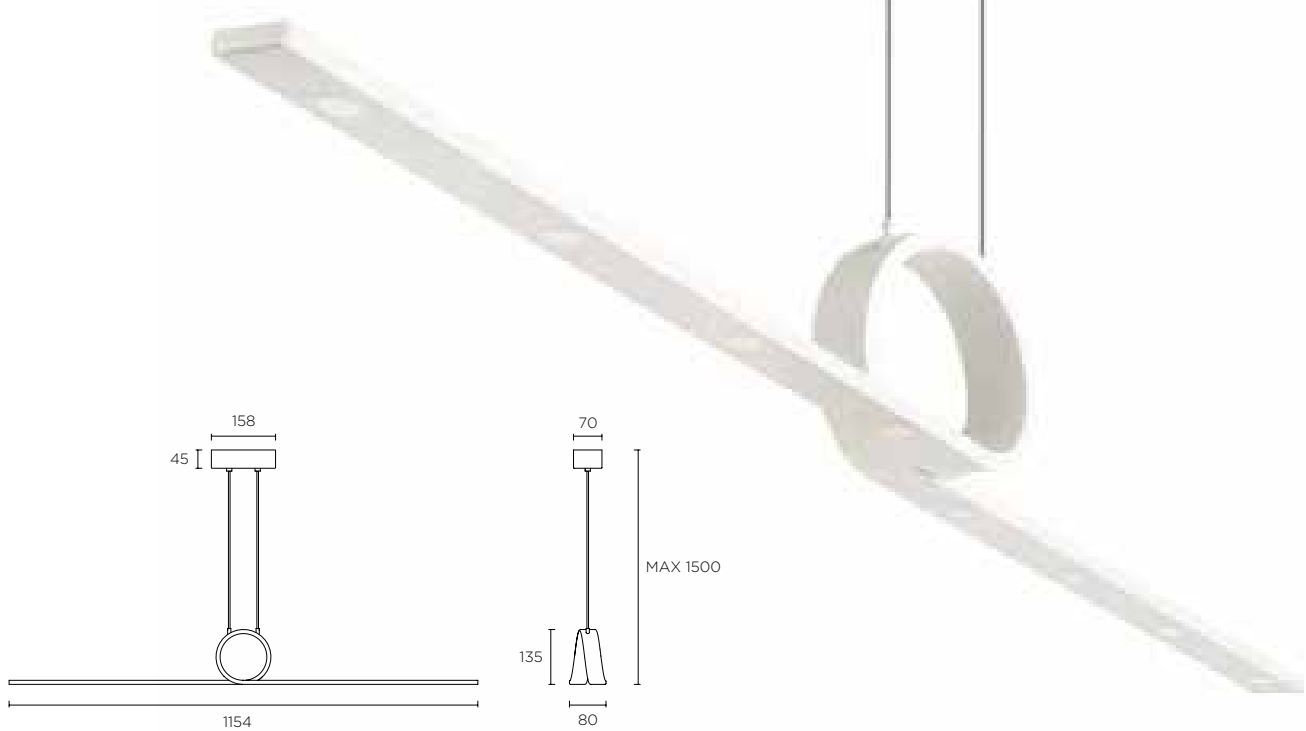

 446-491
**CEILING
FANS**

VENTILADORES
VENTILATEURS DE PLAFOND
DECKENVENTILATOREN
VENTILATORI DA SOFFITTO
VENTILADORES DE TECTO
ВЕНТИЛЯТОРЫ
WENTYLATORY SUFITOWE

CURL









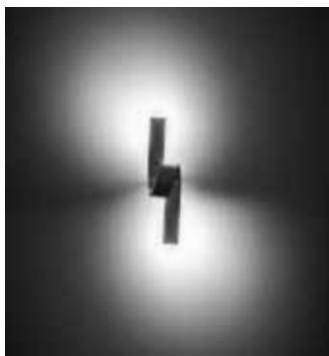

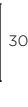

00-2017-14-14 | 00-2287-14-14
 LED CREE 8 X 3W = 24W
 1455 lm^(N) | 3000k









05-2017-14-14
 LED CREE 2 X 3W = 6W
 364 lm^(N) | 3000k

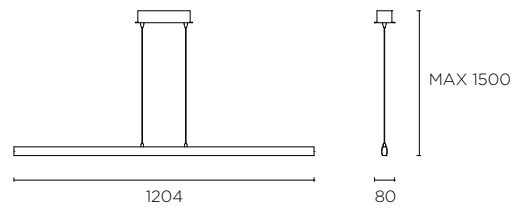
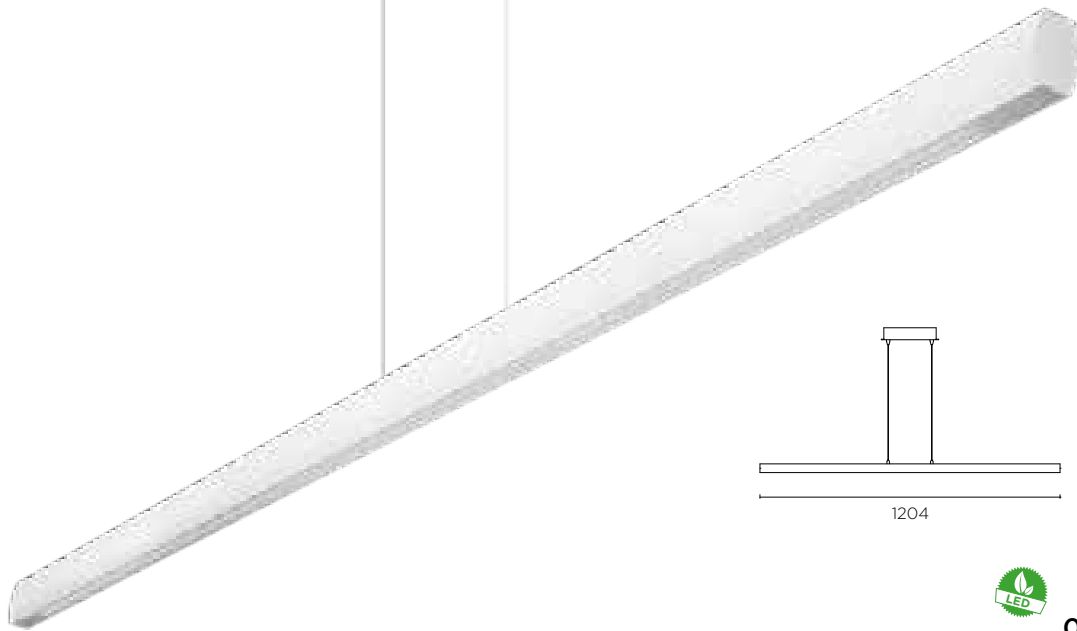

ROAD

NEW



00-3251-14-M1

LED 128 X 0,26W = 33,6W
3910 lm⁽ⁿ⁾ | 3000k

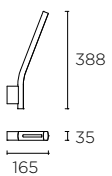
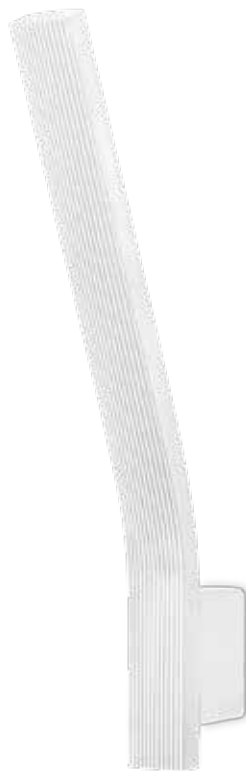

05-3251-14-M1

LED 24 X 0,26W = 6,3W
720 lm⁽ⁿ⁾ | 3000k



SVEN

NEW

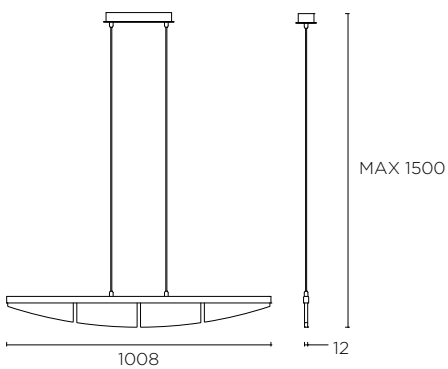

00-3272-S2-37
LED 140 X 0,20W = 28W
2520 lm⁽ⁿ⁾ | 3000k



71-2241-00-00
P. 881





BELL

NEW

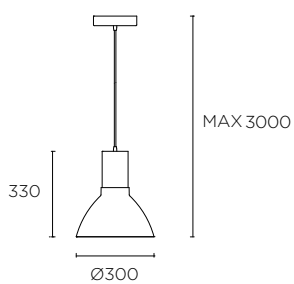

■
00-3219-S2-M2

LED SHARP 18W
1800 lm⁽ⁿ⁾ | 3000k





ROCKET

6 aros de colores incluidos
 6 coloured rings included
 6 anneaux de couleur fournis
 6 farbige Bügel mitgeliefert
 6 anelli colorati inclusi
 6 aros coloridos incluidos
 В комплект входят 6 цветных колец
 Zawartych 6 kolorowych obręczy

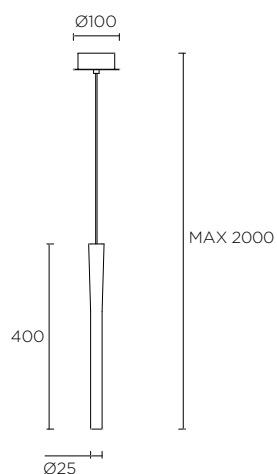
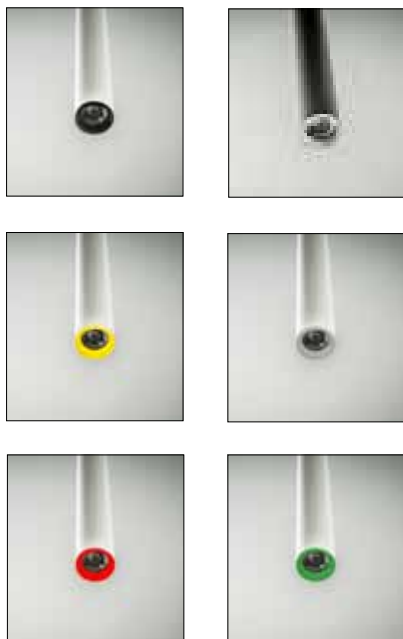

00-3279-16-16 | 00-3279-05-05

LED CREE 1 X 2,2W
 182 lm⁽ⁿ⁾ | 3000k



NEW



Producto personalizado bajo pedido
Customized products available upon request
Produits personnalisés sur commande
Sonderanfertigungen auf Anfrage
Prodotti personalizzabili su richiesta
Produtos personalizados sob encomenda
Продукция, изготовленная на заказ
Zindywidualizowane produkty dostępne na zamówienie



00-3280-05-16
LED CREE 6 X 2,2W
1092 lm⁽ⁿ⁾ | 3000k



00-3280-16-16
LED CREE 6 X 2,2W
1092 lm⁽ⁿ⁾ | 3000k



00-3280-05-05
LED CREE 6 X 2,2W
1092 lm⁽ⁿ⁾ | 3000k

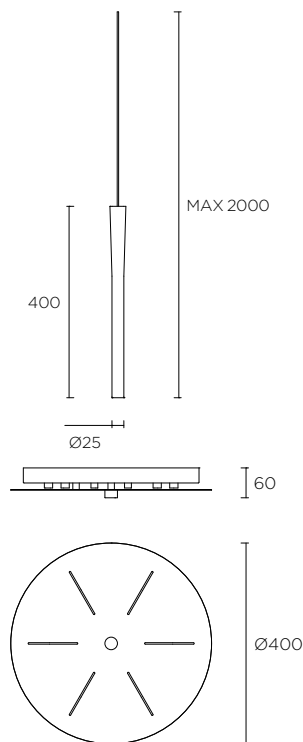

PIPE

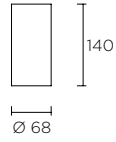

15-0073-14-05
 1 x GU10 50W
 HALOGEN - LED

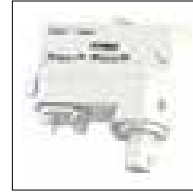

P. 77

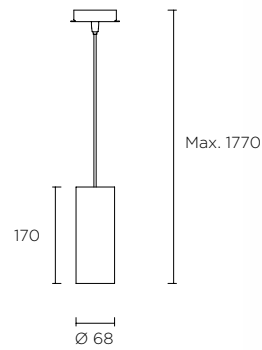

00-0073-14-05
 1 x GU10 50W
 HALOGEN - LED

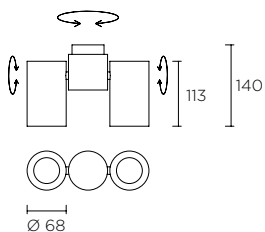

15-0074-14-05
 2 x GU10 50W
 HALOGEN - LED

NEW

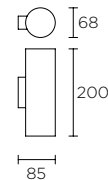

05-2759-14-05
 2 X GU10 50W
 HALOGEN - LED

14 - 05



BLIND

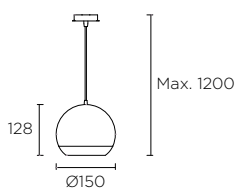

00-1509-14-21

1 X ES-111 75W

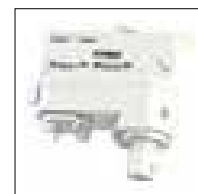

P. 77

14 - 21



DROP

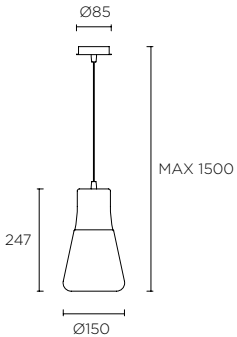

00-2018-21-F9 | 00-2018-14-F9

1 X E-27 MAX. 60W | L= 119 MM Ø= 58 MM

HALOGEN - FLUORESCENT - LED

RECOMMENDED LED ACT-FLL-050

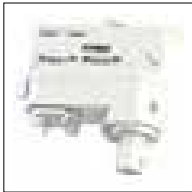

P. 77



NIMES

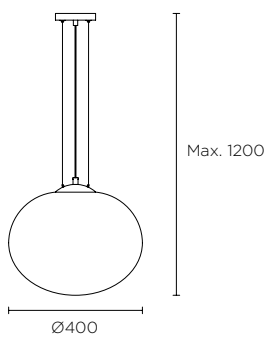

00-1640-81-F9
1 X E-27 MAX. 100W | L= 200 MM
HALOGEN - FLUORESCENT - LED

BUCKET

NEW

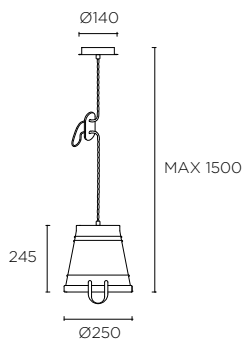

00-2708-16-11 | 00-2708-CG-16

1 X E-27 MAX. 100W | Ø= 180 MM L= 210 MM

HALOGEN - FLUORESCENT - LED

RECOMMENDED GLOBE 18W

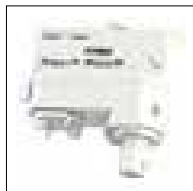

P. 77

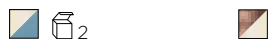
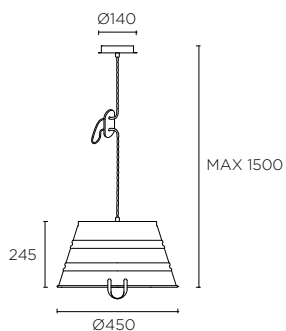
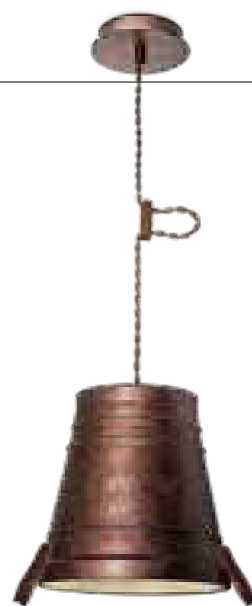

00-2709-16-11 | 00-2709-CG-16

1 X E-27 MAX. 100W | L= 225 MM

HALOGEN - FLUORESCENT - LED

RECOMMENDED GLOBE 18W

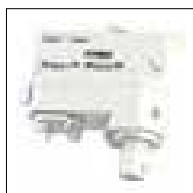

P. 77

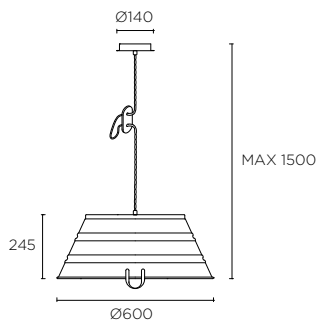

00-2710-16-11 | 00-2710-CG-16

3 X E-27 MAX. 60W | Ø= 140 MM L= 170 MM

HALOGEN - FLUORESCENT - LED

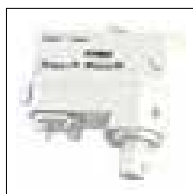

P. 77



16 - 11 CG - 16





NEO

NEW

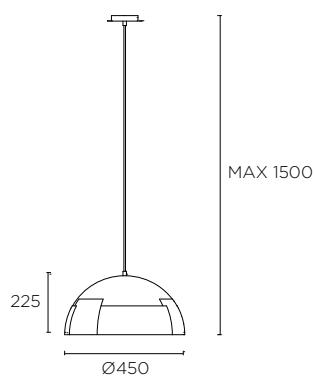

00-2749-E2-16 | 00-2749-T4-11

1 X E-27 MAX. 100W | L= 190 MM
HALOGEN - FLUORESCENT - LED
RECOMMENDED GLOBE 18W



P. 77

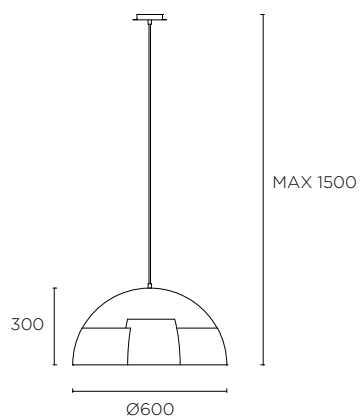

00-2908-E2-16 | 00-2908-T4-11

3 X E-27 MAX. 60W | Ø= 140 MM L= 170 MM
HALOGEN - FLUORESCENT - LED



P. 77

E2 - 16 T4 - 11



Gourmet Lunch

- * Mee Rebus (Mon, Tues)
- * Mee Kari (Wed)
- * Mee Soto (Thurs)
- * Mee Ayam (Fri)
- * Mee Goreng (Sat)
- * Nasi Lemak (Mon, Wed, Fri)
- * Nasi Kerabu (Tue, Thurs)



VINTAGE

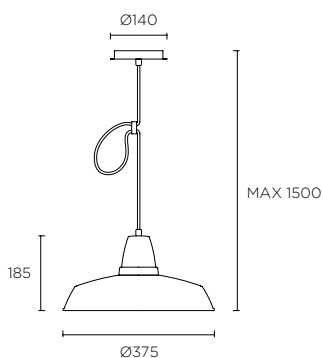

00-1799-S4-CG | 00-1799-21-16

1 X E-27 MAX. 100W
 HALOGEN - FLUORESCENT - LED
RECOMMENDED GLOBE 20W



P. 77

Z6 - 20 16 - 11



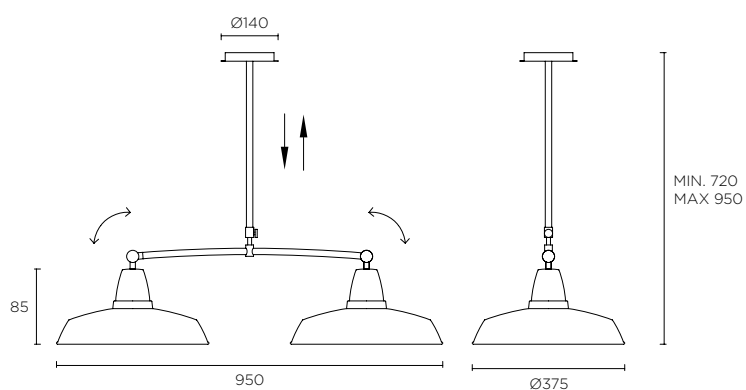

00-2011-S4-CG | 00-2011-21-16

2 X E-27 MAX. 100W
 HALOGEN - FLUORESCENT - LED
RECOMMENDED GLOBE 20W

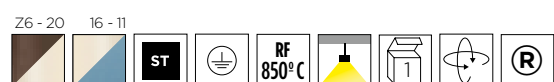

VINTAGE

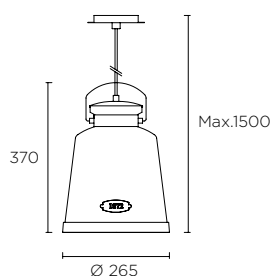

00-0253-S4-CC | 00-0253-21-16
 1 X E-27 MAX. 100W | L= 260 MM
RECOMMENDED GLOBE 20W
 HALOGEN - FLUORESCENT - LED



P. 77



CC-11 16 - 25





■ ■
00-0240-21-Z5 | 00-0240-21-16
 1 X E-27 MAX. 100W | Ø= 85MM L= 175 M
RECOMMENDED GLOBE 20W 
 HALOGEN - FLUORESCENT - LED

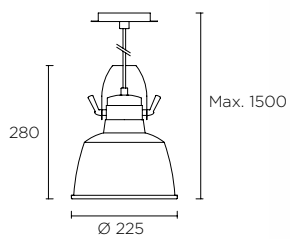

P. 77





Z5 - 10 16 - 25

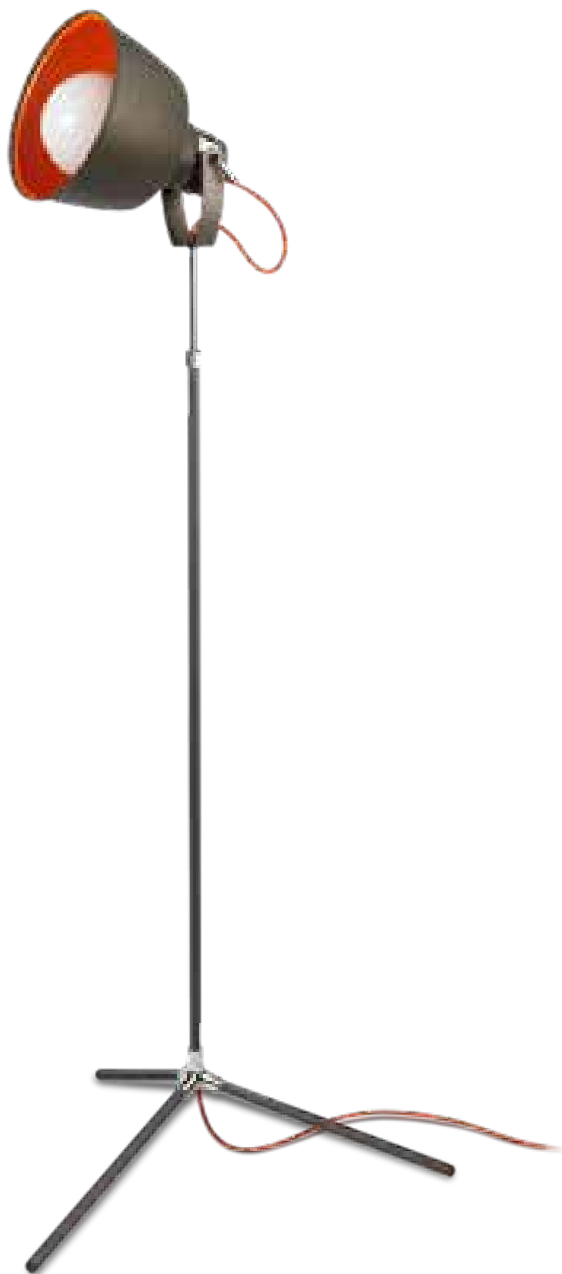

VINTAGE



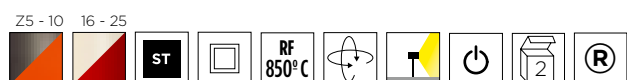
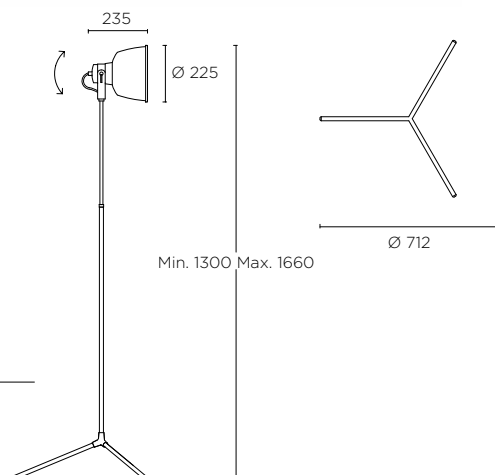

25-0240-21-Z5 | 25-0240-21-16
1 X E-27 MAX. 100W | Ø= 85MM L= 175 MM
RECOMMENDED GLOBE 20W 
HALOGEN - FLUORESCENT - LED



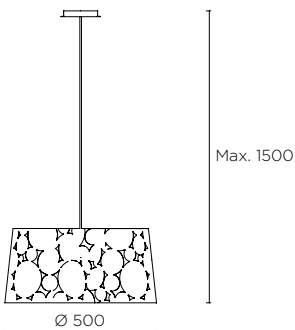

TRAMA



00-4426-14-14
 3 X E-27 MAX. 60W | L= 155 MM
RECOMMENDED GLOBE 20W
 HALOGEN - FLUORESCENT - LED



P. 77

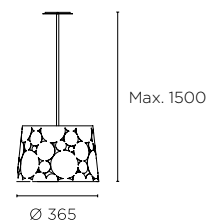

00-4343-05-05 | 00-4343-14-14
 1 X E-27 MAX. 100W | L= 165 MM
RECOMMENDED GLOBE 20W
 HALOGEN - FLUORESCENT - LED



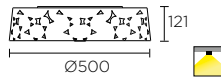

15-4426-14-14

3 X E-27 PL ELEC. MAX. 23W
FLUORESCENT - LED



Ø 280

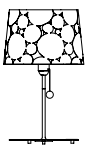

Ø 240



10-4343-14-14

1 X E-27 MAX. 100W | L= 190 MM
RECOMMENDED GLOBE 20W
FLUORESCENT - LED

Ø 365



1600

Ø 315



25-4343-14-14

1 X E-27 MAX. 100W | L= 215 MM
RECOMMENDED GLOBE 20W
HALOGEN - FLUORESCENT - LED



14



TRAMA

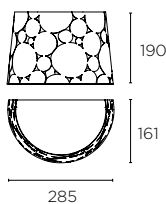

■ □
05-4343-05-05 | 05-4343-14-14
2 X E-27 MAX. 60W | Ø= 50 MM L= 155 MM
HALOGEN - FLUORESCENT - LED





CUMBIA

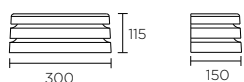

05-2785-21-AS

2 X E-27 PL ELEC. MAX. 20W | Ø= 65 MM L= 135 MM
FLUORESCENT - LED

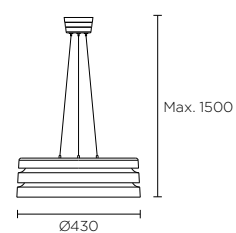
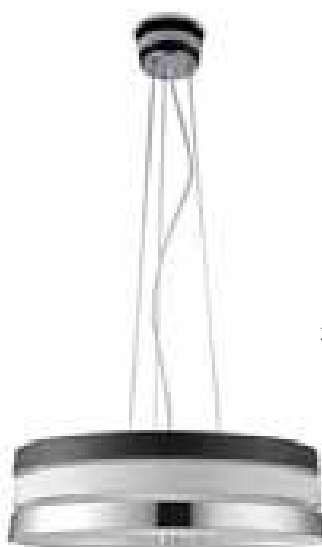

00-2785-21-AS

3 X E-27 PL ELEC. MAX. 20W | L= 125 MM
FLUORESCENT - LED



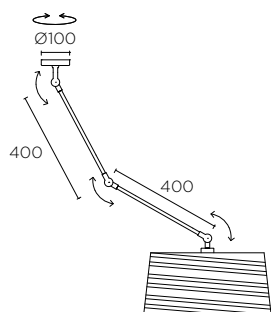

05-2707-81-21 + PAN
 1 X E-27 MAX. 100W | L = 125 MM
RECOMMENDED GLOBE 18W
 HALOGEN - FLUORESCENT - LED

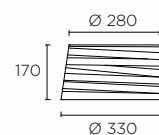

PAN-163-14 | L = 170 MM
PAN-163-05 | L = 170 MM

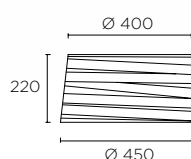

PAN-164-14 | L = 240 MM
PAN-164-05 | L = 240 MM

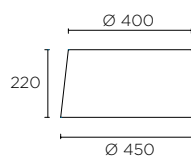

PAN-174-14 | L = 225 MM
PAN-174-05 | L = 225 MM

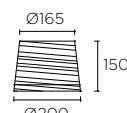

PAN-219-14 | L = 170 MM
PAN-219-05 | L = 170 MM

81 21

MAGMA

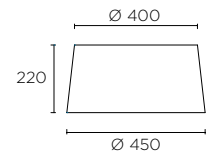

PAN-174-14 | L= 225 MM
PAN-174-05 | L= 225 MM

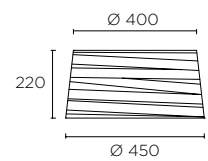

PAN-164-14 | L= 240 MM
PAN-164-05 | L= 240 MM

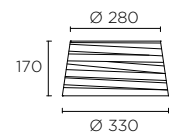

PAN-163-14 | L= 170 MM
PAN-163-05 | L= 170 MM

00-0268-21-82 + 2 X PAN
2 X E-27 MAX. 100W
RECOMMENDED GLOBE 20W
HALOGEN - FLUORESCENT - LED

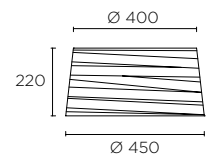
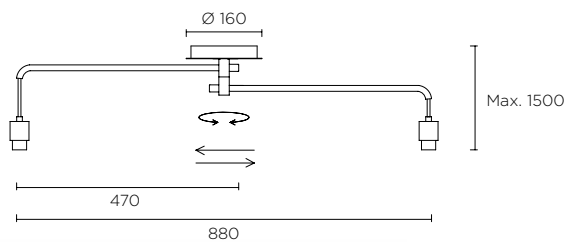

PAN-164-14 | L= 240 MM
PAN-164-05 | L= 240 MM

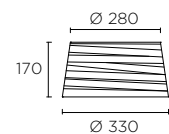

PAN-163-14 | L= 170 MM
PAN-163-05 | L= 170 MM

00-0264-21-82 + PAN
1 X E-27 MAX. 100W
RECOMMENDED GLOBE 20W
HALOGEN - FLUORESCENT - LED

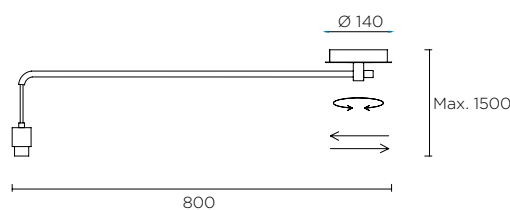



MAGMA

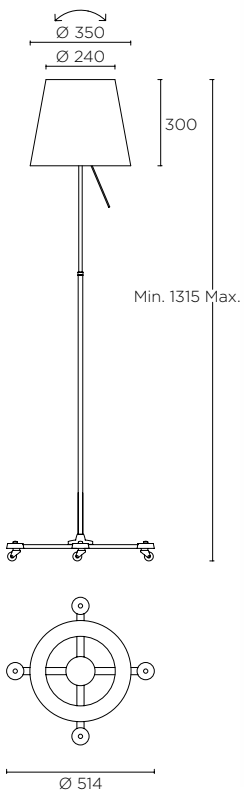

25-0264-21-82 + PAN-165-05

1 X E-27 MAX. 100W | L= 210 MM
RECOMMENDED GLOBE 20W
 HALOGEN - FLUORESCENT - LED



25-0264-21-82 + PAN-165-14

1 X E-27 MAX. 100W | L= 210 MM
RECOMMENDED GLOBE 20W
 HALOGEN - FLUORESCENT - LED

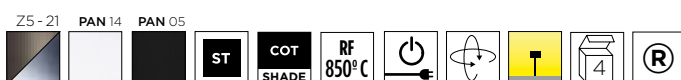



25-0467-21-82 + PAN

1 X E-27 MAX. 100W

RECOMMENDED GLOBE 20W 

HALOGEN - FLUORESCENT - LED

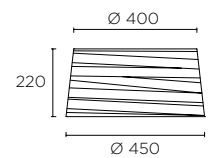
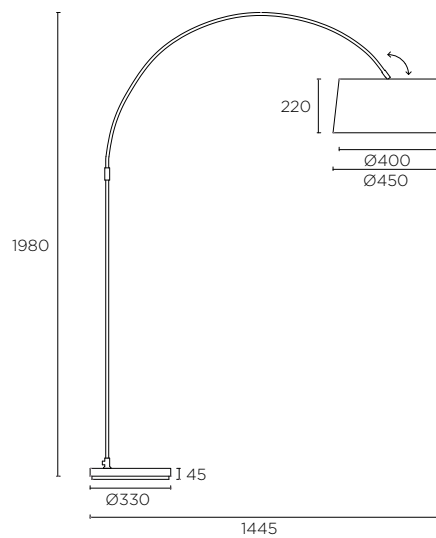

PAN-164-14 | L = 225MM
PAN-164-05 | L = 225MM

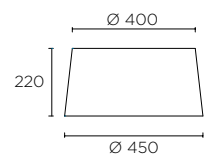

PAN-174-14 | L = 225MM
PAN-174-05 | L = 225MM

21 PAN 14 PAN 05



VIRGINIA

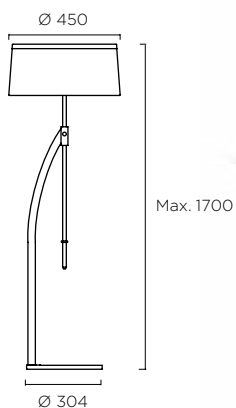

25-4339-21-05

3 X E-27 PL ELEC. MAX. 16W | L= 150 MM
FLUORESCENT - LED

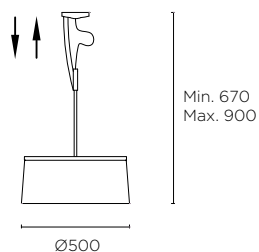

00-4339-21-05

3 X E-27 PL ELEC. MAX. 21W | L= 160 MM
FLUORESCENT - LED



10-4339-21-05

1 X E-27 PL ELEC. MAX. 16W | L= 170 MM
FLUORESCENT - LED

21 - Z5 PAN 05



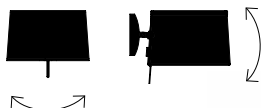
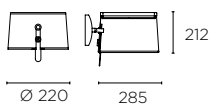

05-4339-21-05
1 X E-27 PL ELEC. MAX. 16W | L= 140 MM
FLUORESCENT - LED



TWIST

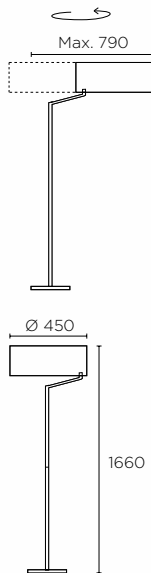
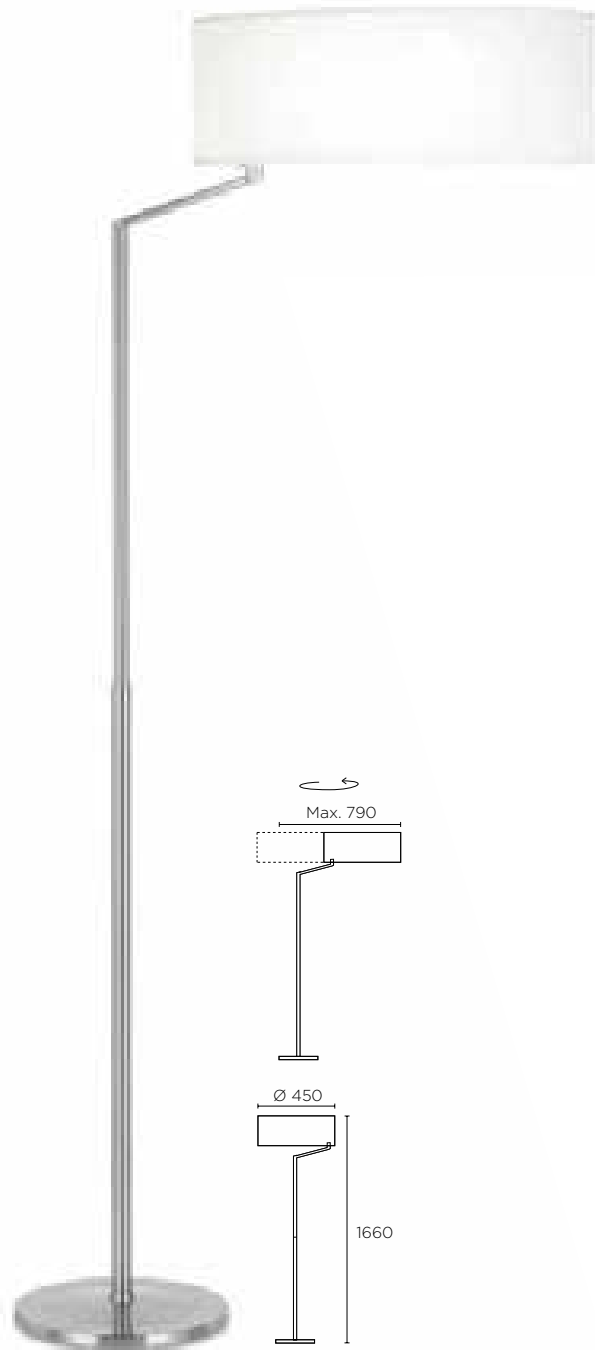

25-2817-81-14
 1 X E-27 MAX. 150W | L= 250 MM
 HALOGEN - FLUORESCENT - LED

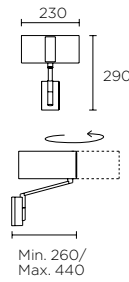

05-2817-81-14
 1 X E-27 MAX. 60W ESF. Ø45 | Ø= 70 MM L= 130 MM
 HALOGEN - FLUORESCENT - LED

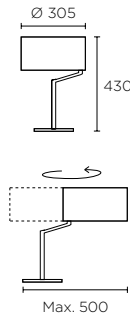

10-2817-81-14
 1 X E-27 MAX. 60W ESF. Ø45 | Ø= 70 MM L= 130 MM
 HALOGEN - FLUORESCENT - LED



UP & DOWN

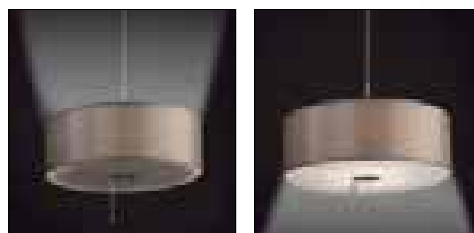
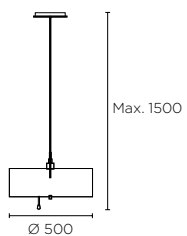

Light UP

Light DOWN



P. 77



00-2713-81-AJ

1 X E-27 HALOGEN MAX. 150W **OSRAM INCLUDED** | Ø= 65 MM L= 145 MM
RECOMMENDED MEGAMAN MU123i
FLUORESCENT - LED



FLORENCIA

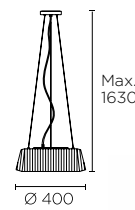
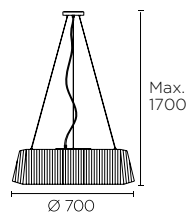

71-4695-81-81

15-4695-XX-M1 + 71-4695-81-81 (Ø400)
15-4696-XX-M1 + 71-4695-81-81 (Ø700)



■ 2 ■
15-4696-J6-M1 | 15-4696-20-M1
3 X E-27 MAX. 40W | Ø= 50 MM L= 200 MM
HALOGEN - FLUORESCENT - LED



■ 4 ■
15-4695-J6-M1 | 15-4695-20-M1
2 X E-27 MAX. 40W | Ø= 50 MM L= 160 MM
HALOGEN - FLUORESCENT - LED



PAN J6 PAN 20



SAN FRANCISCO

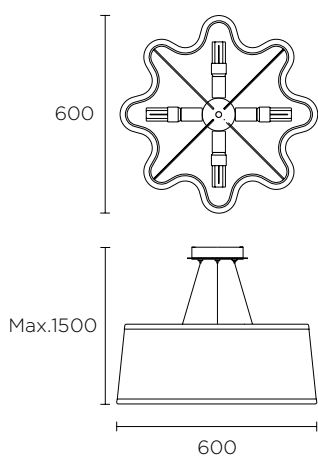

20-2787-21-J6

4 X E-27 MAX. 60W | Ø= 120 MM L= 160 MM
HALOGEN - FLUORESCENT - LED



PROVENZA



20-0544-Y2-20

5 X E-14 MAX. 60W | Ø=100 MM L= 95 MM

HALOGEN - FLUORESCENT - LED

RECOMMENDED MEGAMAN GA807i 

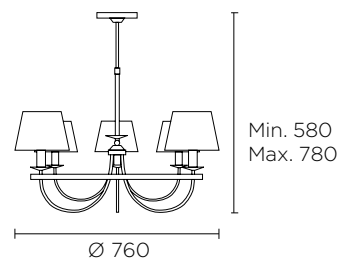

Y2 PAN 20



ALSACIA



Ø 450

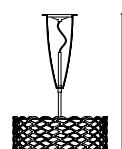
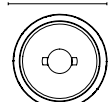

Max. 830
Min. 570



00-4341-Z6-20

3 X E-27 MAX. 60W | Ø=100 MM L= 120 MM
HALOGEN - FLUORESCENT - LED

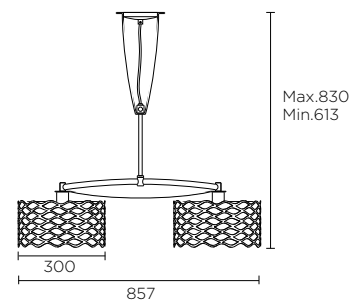

Max.830
Min.613



20-4341-Z6-20

2 X E-27 MAX.100W | L= 120 MM
HALOGEN - FLUORESCENT - LED

Z6 PAN 20



ALSACIA



15-4341-Z6-20

3 X E-27 MAX 40W | Ø= 60 MM L= 170 MM
HALOGEN - FLUORESCENT - LED

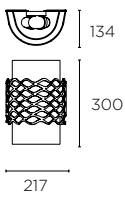
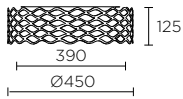

05-4341-Z6-20

2 X E-27 PL ELEC. MAX. 23W | Ø= 60 MM L= 170 MM
FLUORESCENT - LED

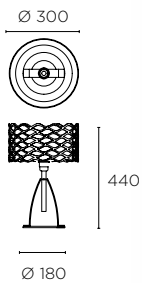

10-4341-Z6-20

1 X E-27 MAX. 100W | L= 150 MM
RECOMMENDED GLOBE 20W
HALOGEN - FLUORESCENT - LED

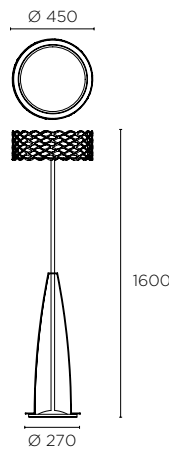

25-4341-Z6-20

3 X E-27 MAX. 60W | Ø= 100 MM L= 120 MM
HALOGEN - FLUORESCENT - LED





VERONESE

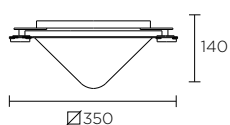

15-2300-S4-15

2 X E-27 MAX. 60W ESF. Ø45 | Ø= 50MM L= 100 MM

RECOMMENDED MEGAMAN 7W GA807i

HALOGEN - FLUORESCENT - LED

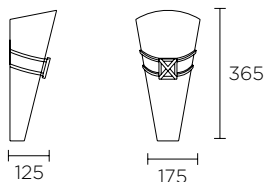

05-2304-S4-15

1 X E-14 MAX. 60W | Ø= 60MM L= 120 MM

HALOGEN - FLUORESCENT - LED



XENIA

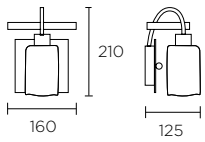

05-0575-Y2-E7

1 X E-14 MAX 60W | Ø= 50 MM L= 100 MM
RECOMMENDED MEGAMAN CL407

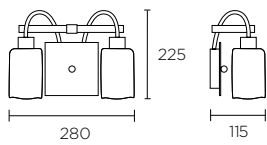

05-0576-Y2-E7

2 X E-14 MAX 60W | Ø= 50 MM L= 100 MM
RECOMMENDED MEGAMAN CL407

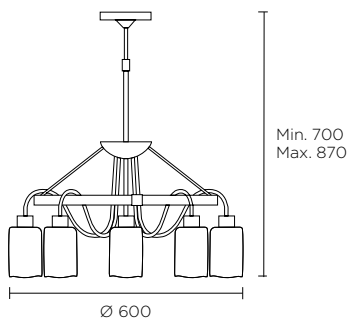

20-0576-Y2-E7

5 X E-14 MAX 60W | Ø= 50 MM L= 100 MM
RECOMMENDED MEGAMAN CL407
 HALOGEN - FLUORESCENT - LED



DRESS UP!

VISTE LA ESTRUCTURA A TU GUSTO.
 DRESS THE STRUCTURE WITH THE SHADE OF YOUR CHOICE.
 HABILILEZ LA STRUCTURE À VOTRE GOÛT.
 STELLEN SIE DIE STRUKTUR NACH IHREM GESCHMACK EIN.
 STRUTTURA IL TUO STILE.
 VESTE A ESTRUTURA A TEU GOSTO.
 ВЫБЕРИТЕ СТРУКТУРУ И АБАЖУР, СОЗДАЙТЕ СВОЮ ЛАМПУ.
 SAM DOBIERZ ABAŻUR DO WYBRANEJ LAMPY.



	XS	S	S	S	M	L	XL
14	PAN 175-14	PAN 177-14	PAN 169-14	PAN 157-14	PAN 161-14	PAN 184-14	PAN 159-14
BY	PAN 175-BY	PAN 177-BY		PAN 157-BY	PAN 161-BY	PAN 184-BY	PAN 159-BY
J6				PAN 158-J6	PAN 162-J6	PAN 185-J6	PAN 160-J6

	XS	S	S	S	M	L
14		PAN 219-14				
05		PAN 219-05				
AJ			PAN 194-AJ			
V7	PAN 198-V7			PAN 199-V7	PAN 220-V7	PAN 221-V7



	XS	S	M	L	S	M	L
14	PAN 178-14	PAN 179-14	PAN 180-14	PAN 181-14	PAN 176-14	PAN 182-14	PAN 183-14
BY	PAN 178-BY	PAN 179-BY	PAN 180-BY	PAN 181-BY	PAN 176-BY	PAN 182-BY	PAN 183-BY
20	PAN 186-20	PAN 187-20	PAN 188-20	PAN 189-20			
T001						PAN 182-T001	PAN 183-T001

HOW TO USE?

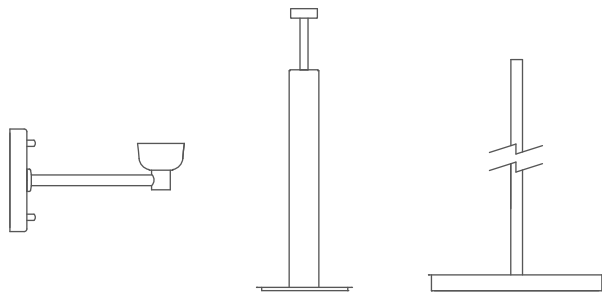

1. STEP

Elige la estructura en el acabado que más te guste.

Choose the structure in the finish that best suits you.

Choisissez la structure dans la finition de votre goût.

Bitte wählen sie die gewünschte struktur.

Scegli la struttura nella rifinitura di tuo gusto.

Escolha a estrutura no acabamento ao seu gosto.

Выберите структуру в желаемой отделке.

Wybierz podstawę w kolorze, który najbardziej pasuje

2. STEP

Elige la forma, tamaño y acabado de la pantalla. Verás nuestras recomendaciones en las páginas siguientes.

Select the shape, size and finish of the shade. You can see our recommendations on the following pages.

Sélectionnez le modèle, la dimension et la finition de l'abat-jour. Vous trouverez quelques-unes de nos recommandations aux pages suivantes.

Bitte wählen sie die form, größe und farbe des lampenschirmes. Unsere Empfehlungen finden Sie in der nächsten Seiten.

Scegli forma, dimensione e rifinitura dello schermo. Nelle pagine seguenti troverai i nostri consigli.

Escolha a forma, o tamanho e o acabamento do abat-jour. Encontrará as nossas recomendações nas páginas seguintes.

Выберите форму, размер и отделку абажура. На следующих страницах Вы увидите наши рекомендации.

wyberz kształt, wielkość i wykończenie abażura. Kieruj się naszymi rekomendacjami na kolejnych stronach.

3. STEP

¡Tu lámpara está lista!

Your lamp is now ready!

Votre luminaire est prêt !

Die Lampe ist fertig!

La tua lampada è pronta!

A sua luminária está pronta.

Ваша лампа готова!

Lampa jest gotowa.



BALI



05-3218-81-82 + PAN 

05-3218-21-82 + PAN

05-3218-E4-82 + PAN

1 X E-27 MAX. 60W ESF. ø45
 HALOGEN - FLUORESCENT - LED
 LED CREE 2,2W
 182 lm⁽⁶⁰⁾

DRESS UP!



PAN 175-14



PAN 175-BY

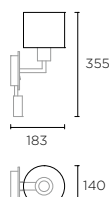

PAN 157-14



PAN 158-J6



PAN 157-BY

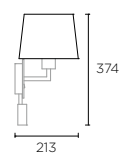

PAN 178-14



PAN 186-20



PAN 178-BY

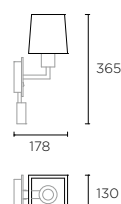

PAN 176-14



PAN 176-BY

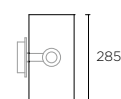
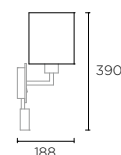

PAN 177-14



PAN 177-BY

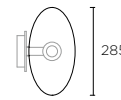
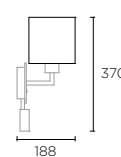

PAN 219-05

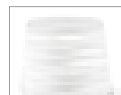

PAN 219-14

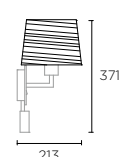

PAN 198-V7

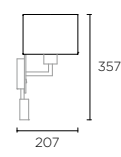





BALI



 **05-3217-81-82 + PAN**

 **05-3217-21-82 + PAN**

 **05-3217-E4-82 + PAN**

1 X E-27 MAX. 60W ESF. ø45
HALOGEN - FLUORESCENT - LED

DRESS UP!



PAN 175-14



PAN 175-BY

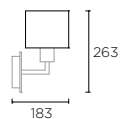

PAN 157-14



PAN 158-J6



PAN 157-BY

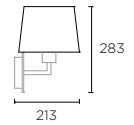

PAN 178-14



PAN 186-20



PAN 178-BY

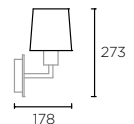

PAN 176-14



PAN 176-BY

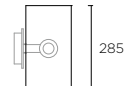
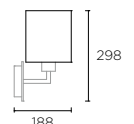

PAN 177-14



PAN 177-BY

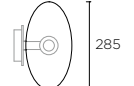
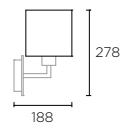

PAN 219-05



PAN 219-14

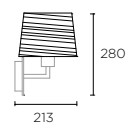

PAN 198-V7

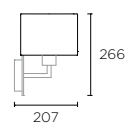

GLOSS



05-2755-81-21 + PAN

1 X E-27 MAX. 60W ESF. ø45
HALOGEN - FLUORESCENT - LED

DRESS UP!



PAN 175-14



PAN 175-BY

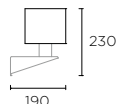

PAN 157-14



PAN 158-J6



PAN 157-BY

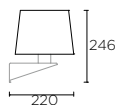

PAN 178-14



PAN 186-20



PAN 178-BY

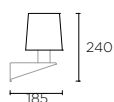

PAN 179-14



PAN 179-BY



PAN 187-20

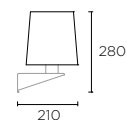

PAN 176-14



PAN 176-BY

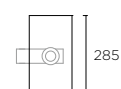
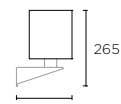

PAN 177-14



PAN 177-BY

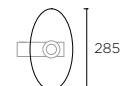
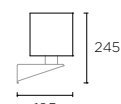

PAN 219-05



PAN 219-14

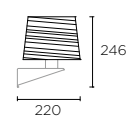

PAN 194-AJ

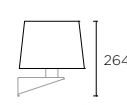

PAN 198-V7

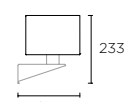

DECORATIVE | DRESS UP

GLOSS



05-2756-81-21 + PAN

1 X E-27 MAX. 60W ESF. ø45
 HALOGEN - FLUORESCENT - LED
 LED CREE 1,1W
 107 lm^(N)



DRESS UP!



PAN 175-14



PAN 175-BY

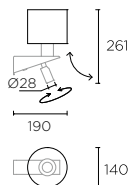

PAN 157-14



PAN 158-J6



PAN 157-BY

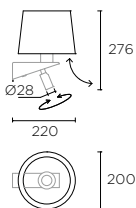

PAN 178-14



PAN 186-20



PAN 178-BY

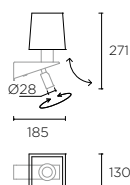

PAN 179-14



PAN 187-20



PAN 179-BY

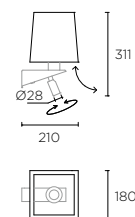

PAN 176-14



PAN 176-BY

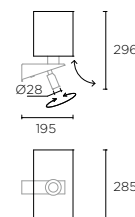

PAN 177-14



PAN 177-BY

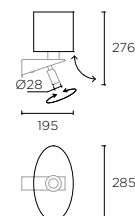

PAN 219-05



PAN 219-14

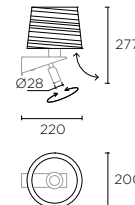

PAN 194-AJ

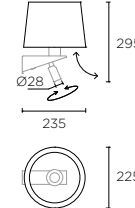

PAN 198-V7

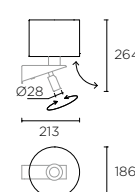



DECORATIVE | DRESS UP

BRISTOL





05-2820-21-21 + PAN 176-14

05-2820-81-81 + PAN | 05-2820-21-21 + PAN
 1 X E-27 MAX. 60W
 HALOGEN - FLUORESCENT - LED
 LED CREE 3W
 182 lm^(N)



DRESS UP!



PAN 175-14



PAN 175-BY

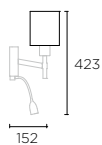

423

152



140



PAN 157-14



PAN 158-J6



PAN 157-BY

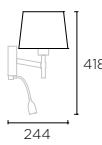

418

244



200



PAN 178-14



PAN 186-20



PAN 178-BY

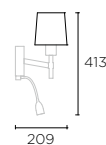

413

209



130



PAN 179-14



PAN 187-20



PAN 179-BY

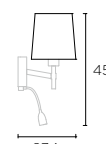

453

234



180



PAN 176-14



PAN 176-BY

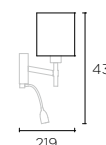

438

219

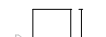

285



PAN 177-14



PAN 177-BY

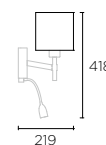

418

219



285



PAN 219-05



PAN 219-14

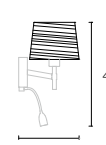

419

244



200



PAN 198-V7

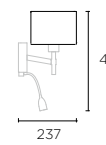

406

237



186



BRISTOL



05-2815-81-81 + PAN 177-BY



05-2815-81-81 + PAN

1 X E-27 MAX. 60W ESF. ø45
HALOGEN - FLUORESCENT - LED

DRESS UP!



PAN 175-14



PAN 175-BY

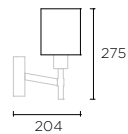

PAN 157-14



PAN 158-J6



PAN 157-BY

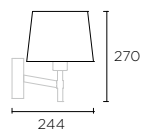

PAN 178-14



PAN 186-20



PAN 178-BY

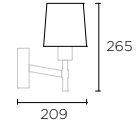

PAN 179-14



PAN 187-20



PAN 179-BY

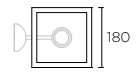
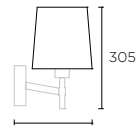

PAN 176-14



PAN 176-BY

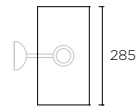
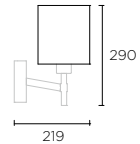

PAN 177-14



PAN 177-BY

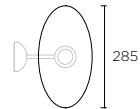
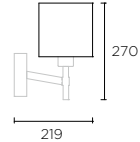

PAN 219-05



PAN 219-14

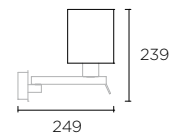

PAN 198-V7

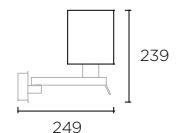

TORINO



05-4697-81-82 + PAN | 05-4697-Y2-82 + PAN
 1 X E-27 MAX. 60W
 HALOGEN - FLUORESCENT - LED

DRESS UP!



PAN 175-14



PAN 175-BY

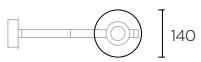
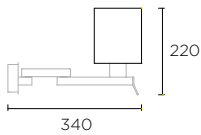

PAN 157-14



PAN 158-J6



PAN 157-BY

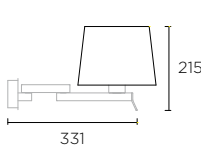

PAN 169-14

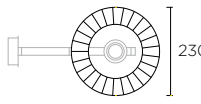
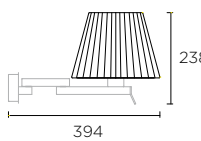

PAN 178-14



PAN 186-20



PAN 178-BY

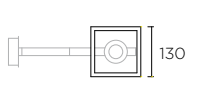
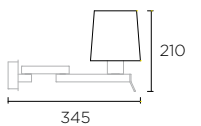

PAN 176-14



PAN 176-BY

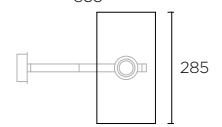
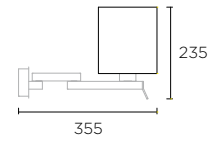

PAN 177-14



PAN 177-BY

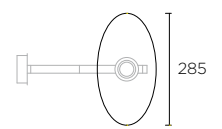
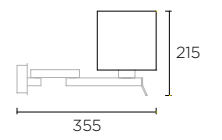

PAN 219-05



PAN 219-14

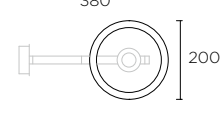
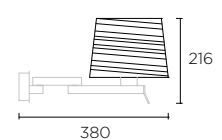

PAN 194-AJ

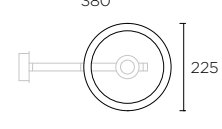

PAN 198-V7

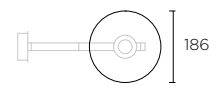
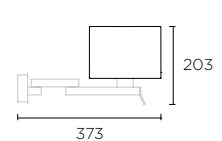

PAN 199-V7

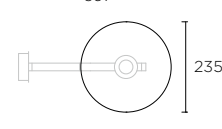
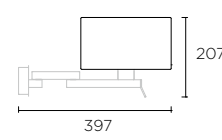

DECORATIVE | DRESS UP



TORINO



05-4696-Y2-82 + PAN 157-14



05-4696-81-82 + PAN



05-4696-Y2-82 + PAN

1 X E-27 MAX. 60W
HALOGEN - FLUORESCENT - LED



DRESS UP!



PAN 175-14



PAN 175-BY

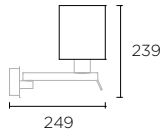

PAN 157-14



PAN 158-J6

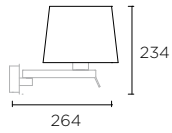

PAN 157-BY



PAN 169-14

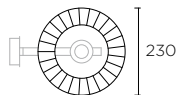
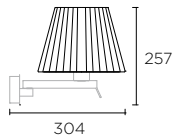

PAN 161-14



PAN 162-J6

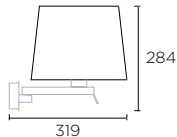

PAN 161-BY



PAN 178-14



PAN 186-20



PAN 178-BY

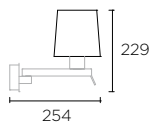

PAN 179-14



PAN 187-20



PAN 179-BY

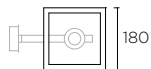
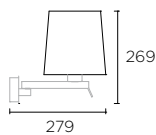

PAN 176-14



PAN 176-BY

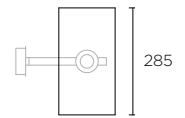
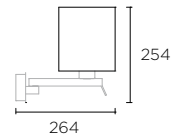

PAN 177-14



PAN 177-BY

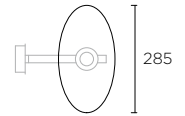
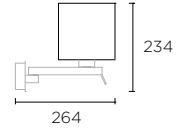

PAN 219-05



PAN 219-14

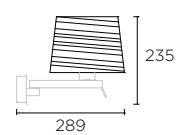

PAN 194-AJ

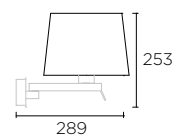

PAN 198-V7

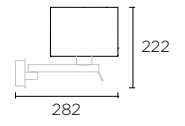

PAN 199-V7

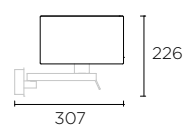

TORINO



05-4695-81-82 + PAN 175-BY



05-4695-Y2-82 + PAN



05-4695-81-82 + PAN

1 X E-27 MAX. 60W

HALOGEN - FLUORESCENT - LED

LED CREE 3W

182 lm⁽⁹⁰⁾



DRESS UP!



PAN 175-14

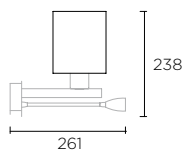

PAN 175-BY

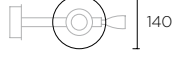

PAN 157-14



PAN 158-J6

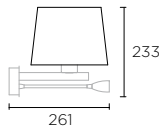

PAN 157-BY

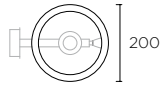

PAN 169-14

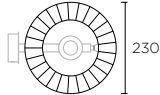
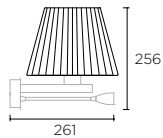

PAN 161-14



PAN 162-J6

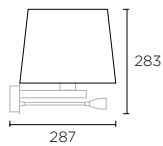

PAN 161-BY

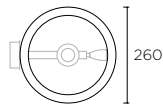

PAN 178-14



PAN 186-20

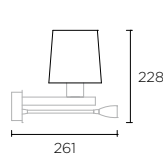

PAN 178-BY

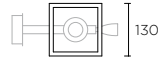

PAN 179-14



PAN 187-20

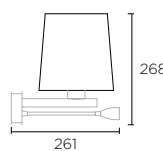

PAN 179-BY

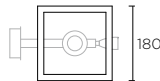

PAN 176-14

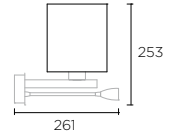

PAN 176-BY

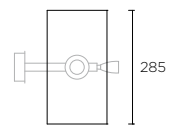

PAN 177-14

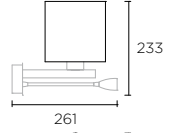

PAN 177-BY

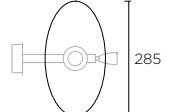

PAN 219-05

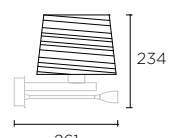

PAN 219-14



PAN 194-AJ

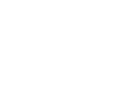
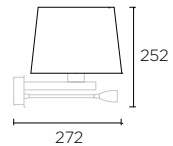

PAN 194-BY

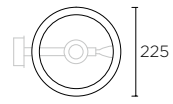

PAN 198-V7

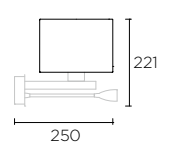

PAN 198-BY



PAN 199-V7

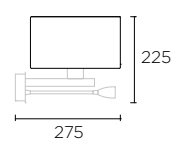

PAN 199-BY

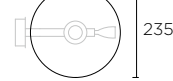

DECORATIVE | DRESS UP

TORINO



10-4696-81-82 + PAN 157-BY



10-4696-81-82 + PAN | 10-4696-Y2-82 + PAN

1 X E-27 MAX. 60W
HALOGEN - FLUORESCENT - LED





10-4696-81-82 + PAN 157-14



DRESS UP!

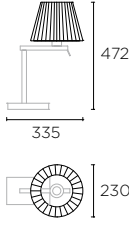

 PAN 157-14	 PAN 158-J6	
 PAN 157-BY		

 PAN 169-14	
	

 PAN 161-14	 PAN 162-J6	
 PAN 161-BY		

 PAN 179-14	 PAN 187-20	
 PAN 179-BY		

 PAN 180-14	 PAN 188-20	
 PAN 180-BY		

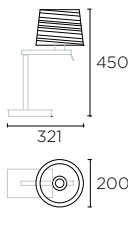

 PAN 176-14	
 PAN 176-BY	

 PAN 177-14	
 PAN 177-BY	

 PAN 219-05	
 PAN 219-14	

 PAN 194-AJ	
	

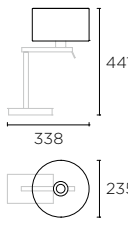
 PAN 198-V7	
	

 PAN 199-V7	
	



TORINO



10-4695-Y2-82 + PAN 161-14



10-4695-21-82 + PAN 219-05

10-4695-81-82 + PAN | **10-4695-Y2-82 + PAN** | **10-4695-21-82 + PAN**

1 X E-27 MAX. 100W
 HALOGEN - FLUORESCENT - LED



81	Y2	21	PAN 05	PAN 14	PAN AJ	PAN BY	PAN 20	PAN V7	ST	COT SHADE		RF 850°C				



DRESS UP!



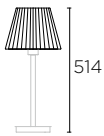
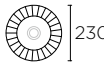

 PAN 157-14	 PAN 158-J6	 491  200
 PAN 157-BY		



 PAN 169-14	 514  230
	

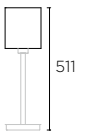
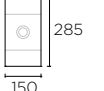

 PAN 161-14	 PAN 162-J6	 541  260
 PAN 161-BY		

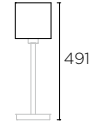

 PAN 179-14	 PAN 187-20	 526  180
 PAN 179-BY		

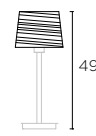

 PAN 180-14	 PAN 188-20	 556  210
 PAN 180-BY		

 PAN 176-14	 511  285 150
 PAN 176-BY	

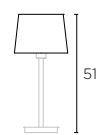
 PAN 177-14	 491  285 150
 PAN 177-BY	

 PAN 219-05	 492  200 150
 PAN 219-14	

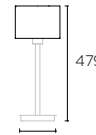
 PAN 194-AJ	 510  225 150
	

 PAN 198-V7	 479  186 150
	

 PAN 199-V7	 483  235 150
	



TORINO



25-4696-81-82 + PAN 185-J6





25-4696-81-82 + PAN 180-14



25-4696-81-82 + PAN | 25-4696-Y2-82 + PAN

1 X E-27 MAX. 100W
HALOGEN - FLUORESCENT - LED



DRESS UP!



PAN 159-14



5



PAN 160-J6



4



PAN 159-BY



5

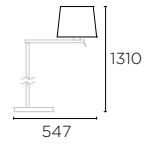

PAN 161-14



5



PAN 162-J6



8



PAN 161-BY



5

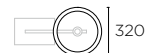
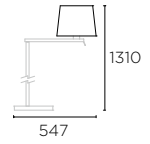

PAN 180-14



PAN 188-20



PAN 180-BY



5

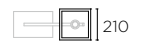
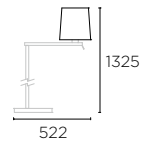

PAN 181-14



PAN 189-20



PAN 181-BY



5

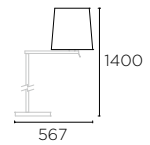

PAN 176-14



PAN 176-BY



6

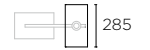
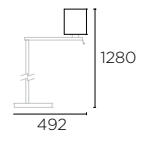

PAN 220-V7

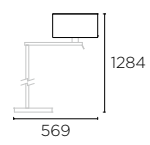

4



DECORATIVE | DRESS UP

TORINO



25-4695-81-82 + PAN 159-BY



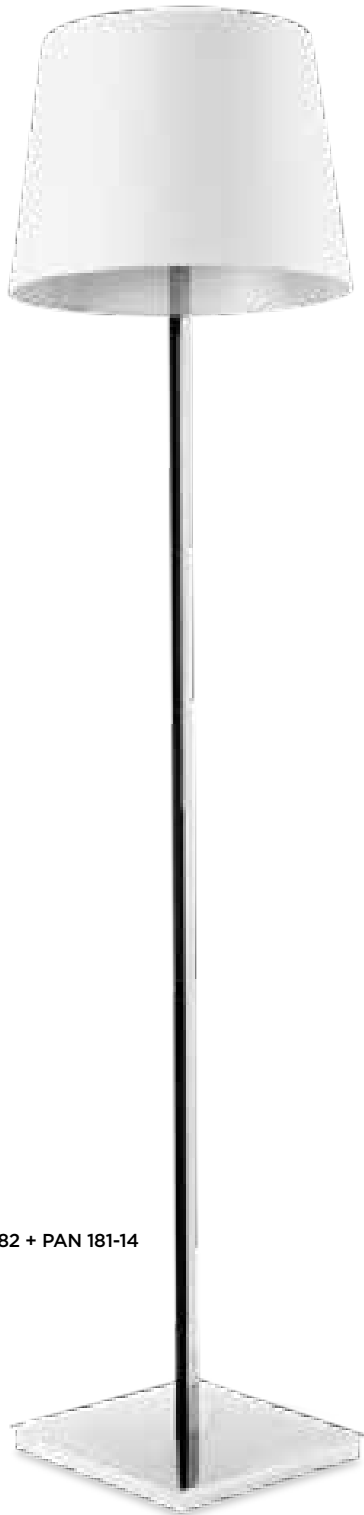

25-4695-21-82 + PAN 181-14

DRESS UP!



PAN 159-14



5



PAN 160-J6



4



PAN 159-BY



5

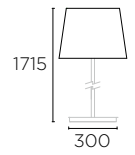

PAN 181-14



PAN 189-20



PAN 181-BY



5

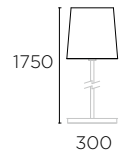

PAN 220-V7



4

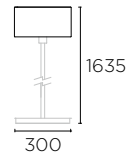

PAN 183-14



PAN 183-T001



PAN 183-BY



4

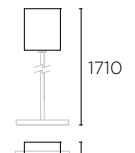

PAN 182-14



PAN 182-T001



PAN 182-BY



4

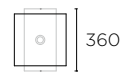
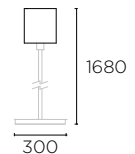

25-4695-81-82 + PAN | 25-4695-Y2-82 + PAN | 25-4695-21-82 + PAN

1 X E-27 MAX. 100W
HALOGEN - FLUORESCENT - LED



DECORATIVE | DRESS UP

OXFORD



05-2840-21-82 + PAN 169-14

05-2840-21-82 + PAN 
 1 X E-27 MAX. 60W
 HALOGEN - FLUORESCENT - LED
 LED CREE 3W
 182 lm⁽ⁿ⁾

DRESS UP!

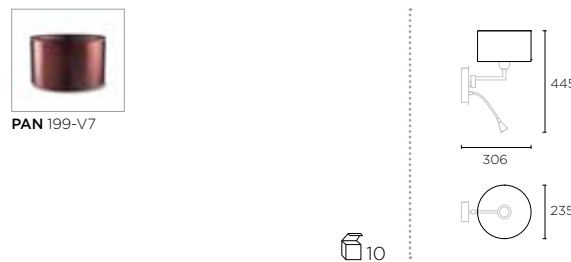
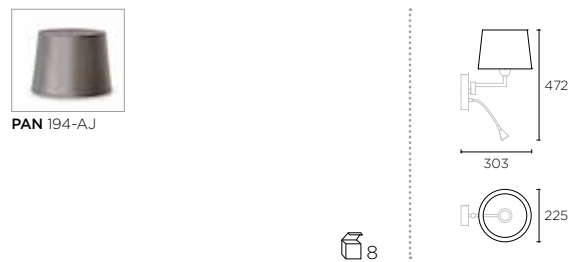
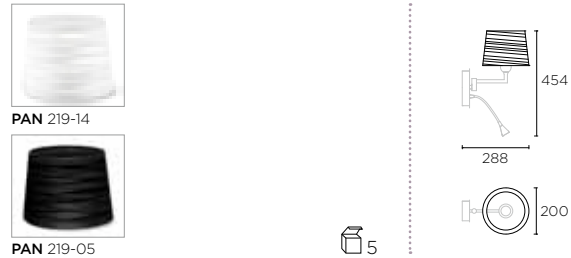
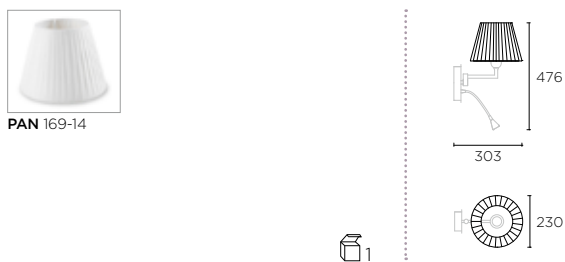

DOVER



172-NS + PAN 178-BY

172-NS + PAN
1 X E-27 MAX. 60W
HALOGEN - FLUORESCENT - LED

DRESS UP!



PAN 175-14



PAN 175-BY

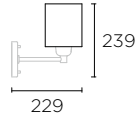

PAN 157-14



PAN 158-J6



PAN 157-BY

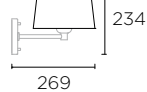

PAN 169-14

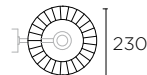
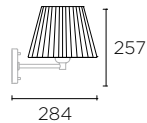

PAN 178-14



PAN 186-20



PAN 178-BY

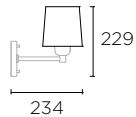

PAN 176-14



PAN 176-BY

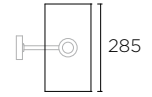
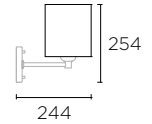

PAN 177-14



PAN 177-BY

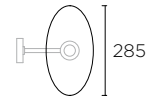
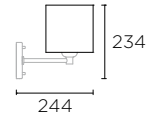

PAN 219-14



PAN 219-05

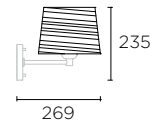

PAN 194-AJ

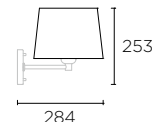

PAN 198-V7

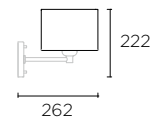

PAN 199-V7

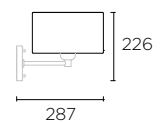

DECORATIVE | DRESS UP

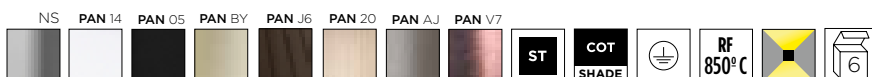

DOVER



171-NS + PAN 179-14



171-NS + PAN

1 X E-27 MAX. 60W
 HALOGEN - FLUORESCENT - LED

NS	PAN 14	PAN 05	PAN BY	PAN J6	PAN 20	PAN AJ	PAN V7	ST	COT SHADE	⊕	RF 850°C	⚡	⚡	6
----	--------	--------	--------	--------	--------	--------	--------	----	-----------	---	----------	---	---	---

DRESS UP!



PAN 175-14

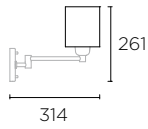

PAN 175-BY



PAN 177-14

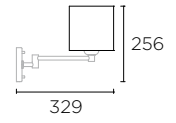

PAN 177-BY

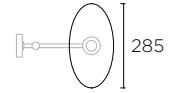

PAN 157-14



PAN 158-J6

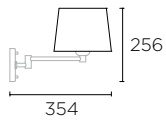

PAN 157-BY

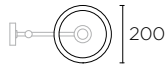

PAN 219-14

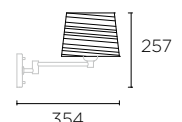

PAN 219-05



PAN 169-14

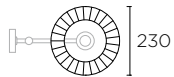
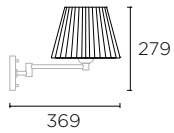

PAN 194-AJ

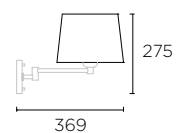

PAN 178-14



PAN 186-20

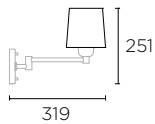

PAN 178-BY

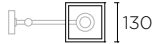

PAN 198-V7

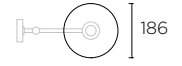
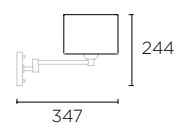

PAN 179-14



PAN 187-20

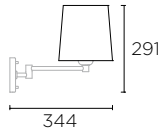

PAN 179-BY

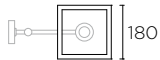

PAN 199-V7

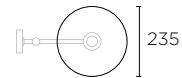
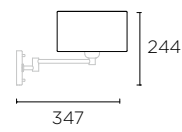

PAN 176-14

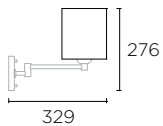

PAN 176-BY

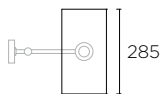

DOVER



170-NS + PAN 179-14



170-NS + PAN

1 X E-27 MAX. 60W
 HALOGEN - FLUORESCENT - LED

NS	PAN 14	PAN 05	PAN BY	PAN J6	PAN 20	PAN AJ	PAN V7	ST	COT SHADE	⊕	RF 850°C	⚡	⚡	6
----	--------	--------	--------	--------	--------	--------	--------	----	-----------	---	----------	---	---	---

DRESS UP!



PAN 175-14

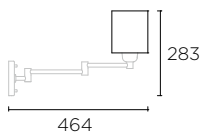

PAN 175-BY



PAN 157-14



PAN 158-J6

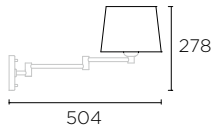

PAN 157-BY

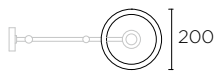

PAN 169-14

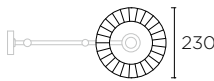
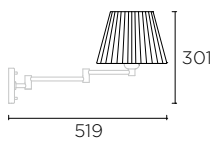

PAN 178-14



PAN 186-20

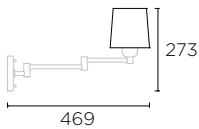

PAN 178-BY

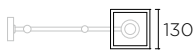

PAN 179-14



PAN 187-20

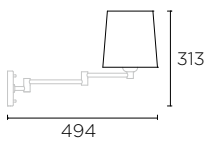

PAN 179-BY

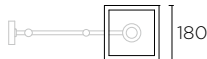

PAN 176-14

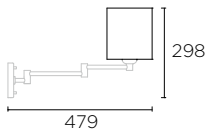

PAN 176-BY

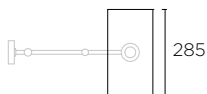

PAN 177-14

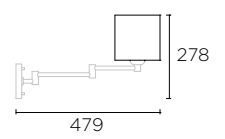

PAN 177-BY

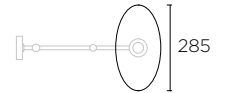

PAN 219-14

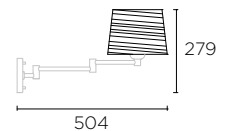

PAN 219-05

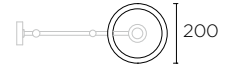

PAN 194-AJ

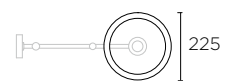
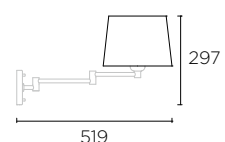

PAN 198-V7

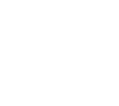
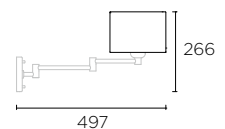

PAN 199-V7

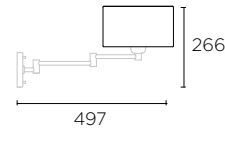

DOVER



174-NS + PAN 157-14



174-NS + PAN

1 X E-27 MAX. 100W
 HALOGEN - FLUORESCENT - LED

NS	PAN 14	PAN 05	PAN BY	PAN J6	PAN 20	PAN AJ	PAN V7	ST	COT SHADE	RF 850° C	Power icon	Atom icon	Box 4 icon	Yellow triangle icon
----	--------	--------	--------	--------	--------	--------	--------	----	-----------	-----------	------------	-----------	------------	----------------------

DRESS UP!



PAN 157-14



5



PAN 158-J6



8

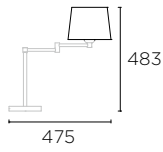

PAN 157-BY



5



PAN 169-14

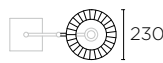
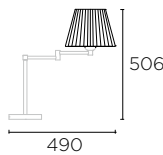

1



PAN 161-14



5



PAN 162-J6



8

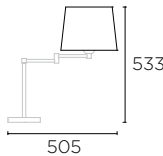

PAN 161-BY



5



PAN 179-14



PAN 187-20

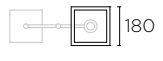
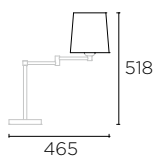

PAN 179-BY



10



PAN 180-14



PAN 188-20

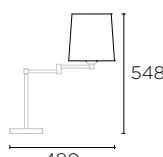

PAN 180-BY



5



PAN 176-14

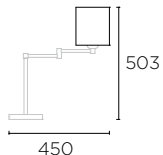

PAN 176-BY



6



PAN 177-14

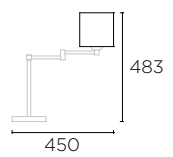

PAN 177-BY



6

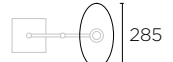

PAN 219-14

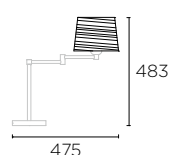

PAN 219-05



5

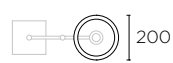

PAN 194-AJ

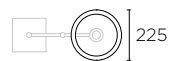
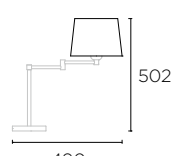

8



PAN 198-V7

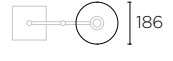
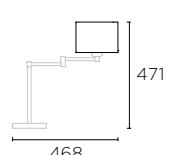

8



PAN 199-V7

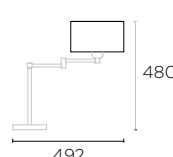

10



DOVER



176-NS + PAN 184-14

DRESS UP!



PAN 184-14



PAN 185-J6

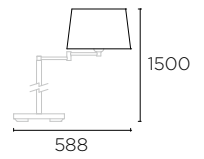

PAN 184-BY



PAN 220-V7

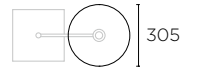
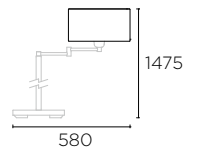

PAN 181-14



PAN 189-20

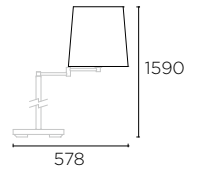

PAN 181-BY

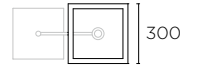

PAN 182-14

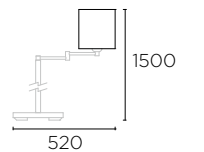

PAN 182-BY



PAN 183-14



PAN 183-T001

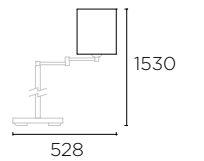

PAN 183-BY



176-NS + PAN

1 X E-27 MAX. 100W
HALOGEN - FLUORESCENT - LED



DEVON



05-2825-21-82 + PAN 176-14



05-2825-21-82 + PAN

1 X E-27 MAX. 60W
HALOGEN - FLUORESCENT - LED

DRESS UP!



PAN 169-14

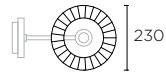
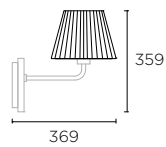

PAN 161-14



PAN 162-J6



PAN 161-BY

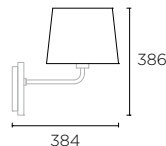

PAN 176-14



PAN 176-BY

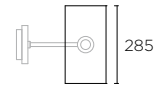
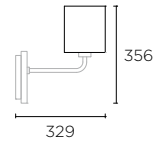

PAN 179-14



PAN 187-20



PAN 179-BY

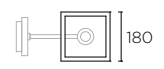
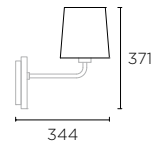

PAN 180-14



PAN 188-BY



PAN 180-BY

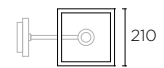
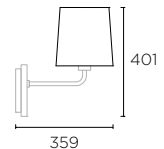

PAN 194-AJ

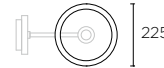
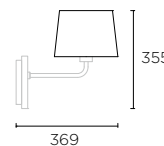

PAN 199-V7

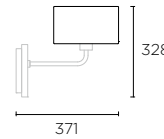

PAN 220-V7

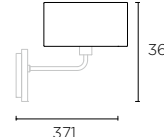

DECORATIVE | DRESS UP



DEVON



10-2825-21-82 + PAN 182-14



10-2825-21-82 + PAN

1 X E-27 MAX. 60W
HALOGEN - FLUORESCENT - LED

DRESS UP!



PAN 161-14



5



PAN 162-J6



8



PAN 161-BY



5

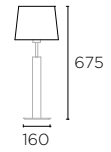

PAN 180-14



PAN 188-20



PAN 180-BY



5

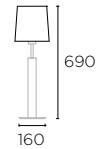

PAN 181-14



PAN 189-20



PAN 181-BY



5

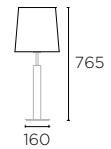

PAN 182-14



PAN 182-T001



PAN 182-BY



10

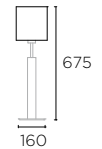

PAN 184-14



5



PAN 185-J6



4



PAN 184-BY



5

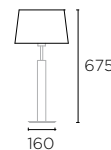

PAN 220-V7

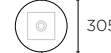
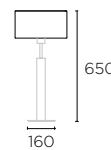

4



DEVON



25-2825-21-14 + PAN 183-14



25-2825-21-82 + PAN 183-T001



25-2825-21-82 + PAN

1 X E-27 MAX. 100W
HALOGEN - FLUORESCENT - LED

DRESS UP!



PAN 181-14



PAN 189-20

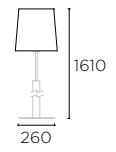

PAN 181-BY



PAN 182-14



PAN 182-T001

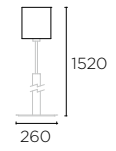

PAN 182-BY



PAN 183-14



PAN 183-T001

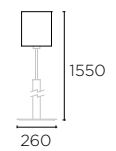

PAN 183-BY



PAN 220-V7

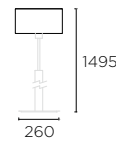

PAN 221-V7

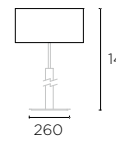

DECORATIVE | DRESS UP

MICHIGAN

NEW

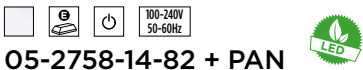

05-2758-14-82 + PAN

1 X E-27 MAX. 60W
 HALOGEN - FLUORESCENT - LED
 1 LED X 1W
 107 lm⁽⁹⁾



05-2757-14-82 + PAN

1 X E-27 MAX. 60W
 HALOGEN - FLUORESCENT - LED



DRESS UP!



PAN 175-14



PAN 175-BY

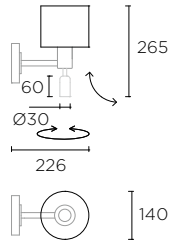

PAN 177-14



PAN 177-BY

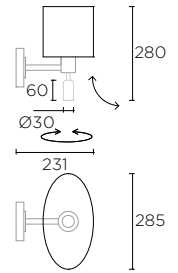

PAN 157-14



PAN 158-J6



PAN 157-BY

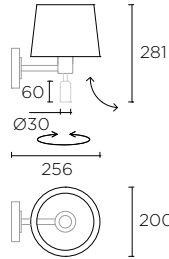

PAN 219-05



PAN 219-14

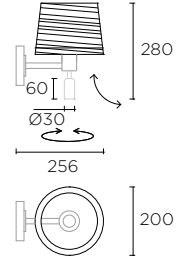

PAN 169-14

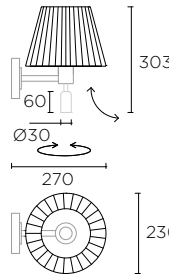

PAN 194-AJ

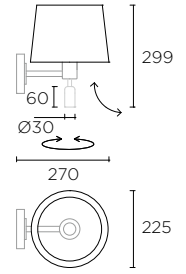

PAN 178-14



PAN 186-20



PAN 178-BY

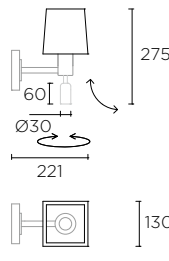

PAN 198-V7

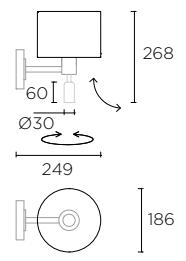

PAN 179-14



PAN 187-20



PAN 179-BY

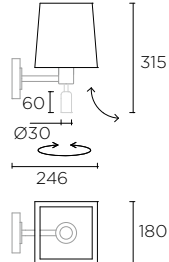

PAN 199-V7

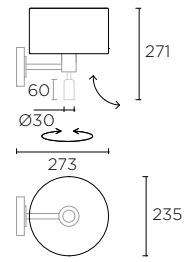

PAN 176-14



PAN 176-BY

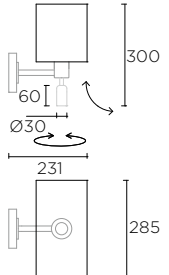

DECORATIVE | DRESS UP

MICHIGAN

NEW



10-2757-14-82 + PAN

1 X E-27 MAX. 60W
HALOGEN - FLUORESCENT - LED



DRESS UP!





		 <p>501</p> <p>Ø150</p> <p>20</p>
		

	 <p>523</p> <p>Ø150</p> <p>23</p>
	

		 <p>551</p> <p>Ø150</p> <p>26</p>
		

		 <p>535</p> <p>Ø150</p> <p>180</p>
		

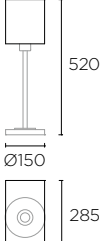

		 <p>565</p> <p>Ø150</p> <p>210</p>
		



	 <p>520</p> <p>Ø150</p> <p>285</p>
	

	 <p>500</p> <p>Ø150</p> <p>285</p>
	

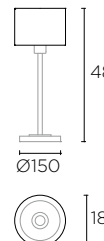
	 <p>500</p> <p>Ø150</p> <p>200</p>
	

	 <p>519</p> <p>Ø150</p> <p>225</p>
	

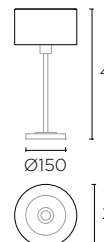
	 <p>488</p> <p>Ø150</p> <p>186</p>
	

	 <p>492</p> <p>Ø150</p> <p>235</p>
	



MICHIGAN

NEW



25-2557-81-82 + PAN 159-14

DRESS UP!



PAN 159-14



PAN 160-J6



PAN 159-BY

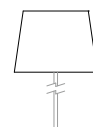

1644

Ø300



420



PAN 181-14



PAN 189-20



PAN 181-BY

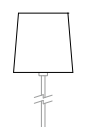

1679

Ø300



300



PAN 182-14



PAN 182-T001



PAN 182-BY

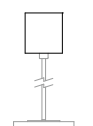

1590

Ø300



360



PAN 183-14



PAN 183-T001



PAN 183-BY

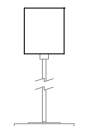

1620

Ø300



400



PAN 220-V7

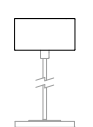

1565

Ø300



305



25-2757-14-82 + PAN

1 X E-27 MAX. 100W
HALOGEN - FLUORESCENT - LED





DECORATIVE | DRESS UP

LYON



05-1567-81-82 + PAN 175-14



DRESS UP!



PAN 175-14



PAN 175-BY

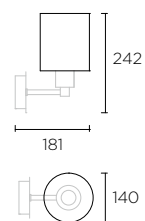

PAN 178-14



PAN 186-20



PAN 178-BY

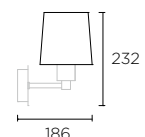

PAN 179-14



PAN 187-20



PAN 179-BY

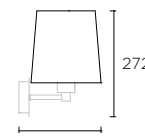

PAN 176-14



PAN 176-BY

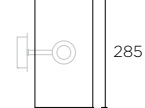
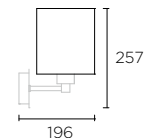

PAN 177-14



PAN 177-BY

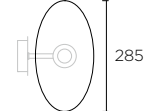
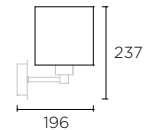

05-1567-81-82 + PAN

1 X E-27 MAX. 60W
HALOGEN - FLUORESCENT - LED





DECORATIVE | DRESS UP

LYON



10-1567-81-82 + PAN 161-BY



10-1567-81-82 + PAN

1 X E-27 MAX. 60W
HALOGEN - FLUORESCENT - LED

10-1567-81-82 + PAN 162-J6

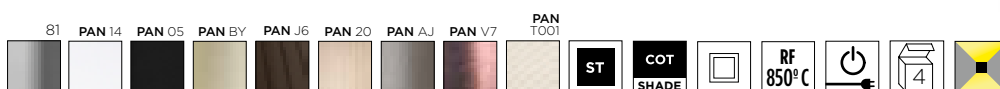

DRESS UP!



		
PAN 157-14 	PAN 158-J6 	
		
PAN 157-BY 		

		
PAN 161-14 	PAN 162-J6 	
		
PAN 161-BY 		

		
PAN 169-14		
		
		

		
PAN 176-14		
		
PAN 176-BY 		

		
PAN 177-14		
		
PAN 177-BY 		

		
PAN 179-14	PAN 187-20	
		
PAN 179-BY 		







		
PAN 180-14	PAN 188-20	
		
PAN 180-BY 		

		
PAN 181-14	PAN 189-20	
		
PAN 181-BY 		

		
PAN 182-14	PAN 182-T001	
		
PAN 182-BY 		

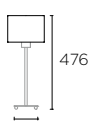
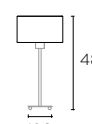
		
PAN 219-05		
		
PAN 219-14 		

		
PAN 194-AJ		
		
		

			
PAN 198-V7 	PAN 199-V7 		
			



LYON



■
25-1567-81-82 + PAN
1 X E-27 MAX. 100W
HALOGEN - FLUORESCENT - LED

81	PAN 14	PAN BY	PAN J6	PAN 20	PAN V7	PAN T001	ST	COT SHADE	RF 850°C	4	⚡



25-1567-81-82 + PAN 159-BY

DRESS UP!



PAN 159-14



5



PAN 160-J6



4



PAN 159-BY



5

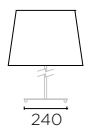

1605

240



420



PAN 181-14



PAN 189-20



PAN 181-BY



5



1640

240



300



PAN 182-14



PAN 182-T001



PAN 182-BY



4

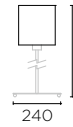

1550

240



360



PAN 183-14



PAN 183-T001



PAN 183-BY



4

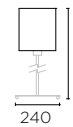

1580

240



400



PAN 184-14



5



PAN 185-J6



4



PAN 184-BY



5



1550

240



320



PAN 220-V7



4

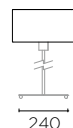

1525

240



305



PAN 221-V7



1



1515

240



440



FEI



05-1136-16-82 + PAN 166-20



05-1136-16-82 + PAN 157-BY



05-1136-16-82 + PAN

1 X E-27 MAX. 60W
HALOGEN - FLUORESCENT - LED



DRESS UP!





 PAN 157-14	 PAN 158-J6	 345 226
 PAN 157-BY	 200	



 PAN 169-14	 368 241
 230	

 PAN 175-14	 350 186
 PAN 175-BY	

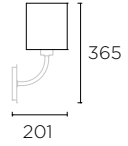
 PAN 179-14	 PAN 187-20	 380 216
 PAN 179-BY	 180	

 PAN 180-14	 PAN 188-20	 410 231
 PAN 180-BY	 210	

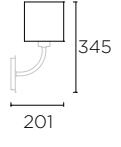
 PAN 176-14	 365 201
 PAN 176-BY	

 PAN 177-14	 345 201
 PAN 177-BY	

 PAN 178-14	 PAN 186-20	 340 191
 PAN 178-BY	 140	

 PAN 166-20	 380 201
 150	

 PAN 219-05	 346 226
 PAN 219-14	

 PAN 194-AJ	 364 241
 225	

 PAN 198-V7	 333 220
 186	



FEI



10-4368-16-82 + PAN 161-BY



10-4368-16-82 + PAN



1 X E-27 MAX. 75W
HALOGEN - FLUORESCENT - LED



DRESS UP!

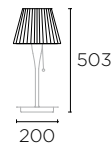

 PAN 157-14	 PAN 158-J6	 480  200
 PAN 157-BY	 PAN 158-J6	

 PAN 169-14	 503  230
 PAN 169-14	

 PAN 161-14	 PAN 162-J6	 530  260
 PAN 161-BY	 PAN 162-J6	



 PAN 179-14	 PAN 187-20	 515  180
 PAN 179-BY	 PAN 187-20	

 PAN 180-14	 PAN 188-20	 545  210
 PAN 180-BY	 PAN 188-20	



 PAN 176-14	 500  285
 PAN 176-BY	

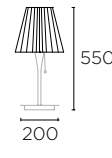
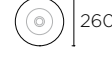



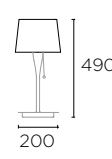

 PAN 177-14	 480  285
 PAN 177-BY	

 PAN 182-14	 PAN 182-T001	 530  360
 PAN 182-BY	 PAN 182-T001	

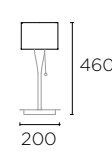
 PAN 153-20	 550  260
 PAN 153-20	

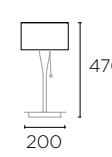
 PAN 219-05	 480  200
 PAN 219-14	

 PAN 194-AJ	 490  220
 PAN 194-AJ	

 PAN 198-V7	 460  200	 PAN 199-V7	 470  235
 PAN 198-BY		 PAN 199-BY	



FEI



10-4367-16-82 + PAN
 1 X E-27 MAX. 60W
 HALOGEN - FLUORESCENT - LED

DRESS UP!

 PAN 157-14	 PAN 158-J6	
 PAN 157-BY		
		

 PAN 169-14	
	



 PAN 179-14	 PAN 187-20	
 PAN 179-BY		
		

 PAN 176-14	
 PAN 176-BY	

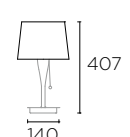

 PAN 177-14	
 PAN 177-BY	
	

 PAN 151-20	
	

 PAN 219-05	
 PAN 219-14	
	

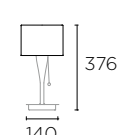
 PAN 194-AJ	
	

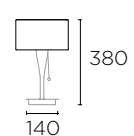
 PAN 198-V7	
	

 PAN 199-V7	
	

16	PAN 14	PAN 20	PAN BY	PAN J6	PAN AJ	PAN V7	ST	COT SHADE		RF 850°C					
----	--------	--------	--------	--------	--------	--------	----	-----------	--	----------	--	--	--	--	--

FEI



25-4367-16-82 + PAN 159-BY

25-4367-16-82 + PAN

1 X E-27 MAX. 150W
HALOGEN - FLUORESCENT - LED

DRESS UP!

													
---	---	---	---	---	---	---	---	---	---	---	---	---	---

DECORATIVE | DRESS UP

MILAN

10-1568-81-82 + PAN 157-14



10-1568-81-82 + PAN

1 X E-27 MAX. 60W
HALOGEN - FLUORESCENT - LED

DRESS UP!



PAN 157-14



PAN 158-J6



PAN 157-BY



Min. 480
/ Max. 600

Min. 210 / Max. 440



200



PAN 161-14



PAN 162-J6



PAN 161-BY



Min. 530
/ Max. 650

Min. 240 / Max. 470



260



PAN 169-14



Min. 500
/ Max. 620

Min. 220 / Max. 450



230



PAN 179-14



PAN 187-20



Min. 515
/ Max. 635

Min. 200 / Max. 430



PAN 179-BY



191



PAN 180-14



PAN 188-20



Min. 545
/ Max. 665

Min. 210 / Max. 440



PAN 180-BY



210



PAN 219-05



Min. 480
/ Max. 600

Min. 210 / Max. 440



PAN 219-14



200



PAN 194-AJ



Min. 500
/ Max. 620

Min. 225 / Max. 455



225



PAN 198-V7



Min. 470
/ Max. 590

Min. 195 / Max. 435



190



PAN 199-V7



Min. 475
/ Max. 595

Min. 220 / Max. 460



235

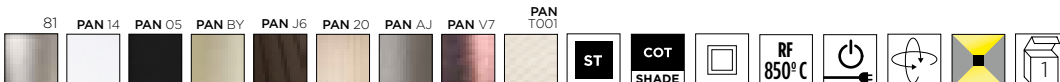

MILAN



25-1568-81-82 + PAN 161-14



25-1568-81-82 + PAN

1 X E-27 MAX. 100W
HALOGEN - FLUORESCENT - LED

DRESS UP!



PAN 161-14



PAN 162-J6



PAN 161-BY

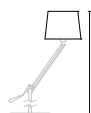

Min. 1380
/Max. 1590
Min. 520 / Max. 660



280



PAN 180-14



PAN 188-20



PAN 180-BY

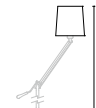

Min. 1395
/Max. 1605
Min. 500 / Max. 640



280



PAN 181-14



PAN 189-20



PAN 181-BY



Min. 1480
/Max. 1690
Min. 540 / Max. 680



300



PAN 182-14



PAN 182-T001



PAN 182-BY

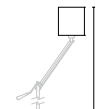

Min. 1380
/Max. 1590
Min. 500 / Max. 640



360



PAN 184-14



PAN 185-J6



PAN 184-BY



Min. 1380
/Max. 1590
Min. 530 / Max. 670



320



PAN 220-V7

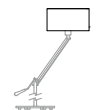

Min. 1355
/Max. 1565
Min. 540 / Max. 680



305



PAN 221-V7

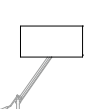

Min. 1340
/Max. 1550
Min. 610 / Max. 750



440



DECORATIVE | DRESS UP

DENVER



05-1566-81-82 + PAN 175-14

05-1566-81-82 + PAN
 1 X E-27 MAX. 60W
 HALOGEN - FLUORESCENT - LED

DRESS UP!



PAN 175-14



PAN 175-BY

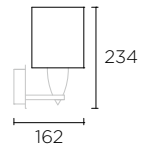

PAN 178-14



PAN 186-20

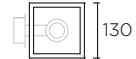
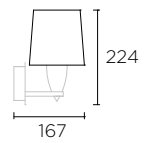

PAN 178-BY



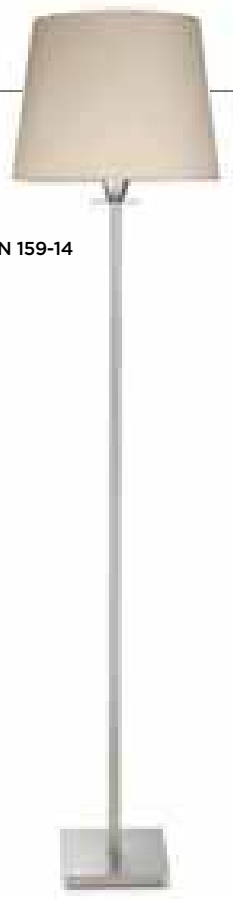

25-1566-81-82 + PAN 159-14

25-1566-81-82 + PAN
 1 X E-27 MAX. 100W
 HALOGEN - FLUORESCENT - LED

DRESS UP!



PAN 159-14



PAN 160-J6

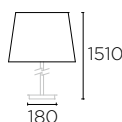

PAN 159-BY



PAN 161-14



PAN 162-J6

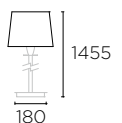

PAN 161-BY

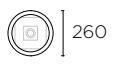

PAN 180-14



PAN 188-20

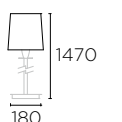

PAN 180-BY



PAN 181-14



PAN 189-20

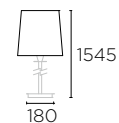

PAN 181-BY



PAN 182-14



PAN 182-T001

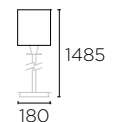

PAN 182-BY



PAN 183-14



PAN 183-T001

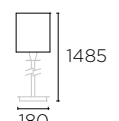

PAN 183-BY



PAN 184-14



PAN 185-J6

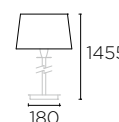

PAN 184-BY



PAN 220-V7

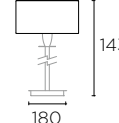

PAN 221-V7



PAN 221-V7

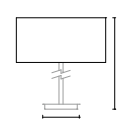

PAN 221-V7

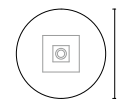

DECORATIVE | DRESS UP

DENVER



10-1566-81-82 + PAN 161-14



10-1566-81-82 + PAN

1 X E-27 MAX. 60W
HALOGEN - FLUORESCENT - LED



DRESS UP!



		 376 120
		
		 200

		 399 120
		23

		 426 120
		
		 260

		 396 120
		
		 285

		 371 120
		
		 130



		 376 120
		
		 285

		 411 120
		
		 180

		 441 120
		
		 210

		 375 120
		
		 200

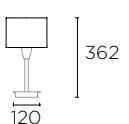
		 393 120
		 225

		 362 120
		 186

		 366 120
		 235



SPICA



05-2510-Z6-82 + PAN 198-V7



05-2510-Z6-82 + PAN

1 X E-27 MAX 60W

HALOGEN - FLUORESCENT - LED

RECOMMENDED MINI CANDLE 9W

DRESS UP!



PAN 157-14



PAN 158-J6



PAN 157-BY



PAN 219-14

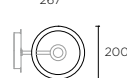
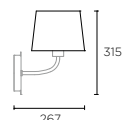

PAN 169-14

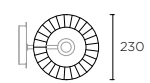
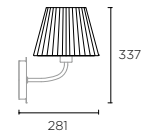

PAN 175-14



PAN 175-BY

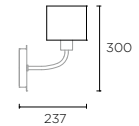

PAN 176-14



PAN 176-BY

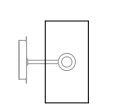
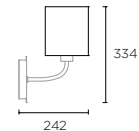

PAN 177-14



PAN 177-BY

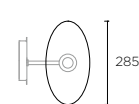
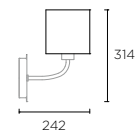

PAN 178-14



PAN 186-20



PAN 178-BY

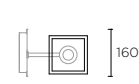
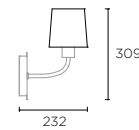

PAN 198-V7

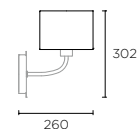

SPICA



10-4369-Z6-82 + PAN

1 X E-27 MAX. 100W
HALOGEN - FLUORESCENT - LED

DRESS UP!



PAN 161-14



PAN 162-J6



PAN 161-BY



PAN 219-14

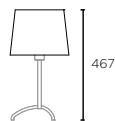

467



260



PAN 169-14



467



250



PAN 176-14



PAN 176-BY

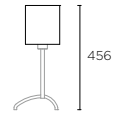

456

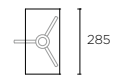

285



PAN 177-14



PAN 177-BY

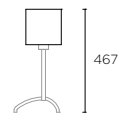

467



285



PAN 180-14



PAN 188-20



PAN 180-BY

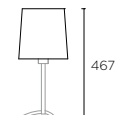

467

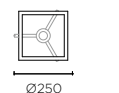

Ø250



PAN 184-14



PAN 185-J6



PAN 184-BY

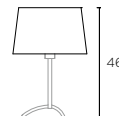

467



320



PAN 220-V7

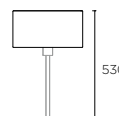

530



305



DECORATIVE | DRESS UP

SPICA

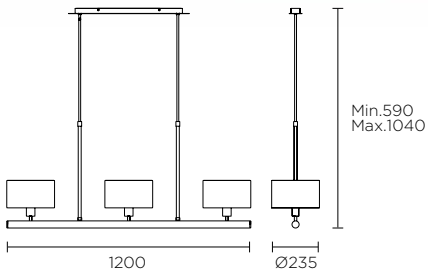

20-2510-Z6-82 + PAN

3 X E-27 MAX. 60W

HALOGEN - FLUORESCENT - LED

RECOMMENDED MINI CANDLE 9W

DRESS UP!



PAN 157-14



PAN 158-J6



PAN 157-BY



PAN 219-14

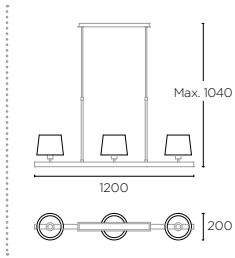

PAN 161-14



PAN 162-J6



PAN 161-BY

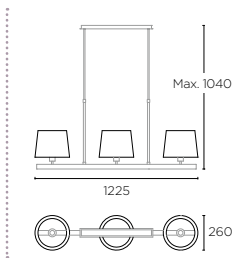

PAN 169-14

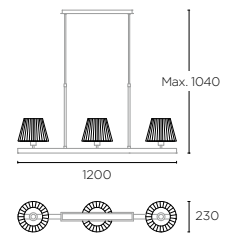

PAN 175-14



PAN 175-BY

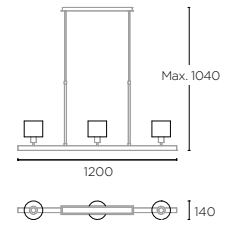

PAN 178-14



PAN 186-20



PAN 178-BY

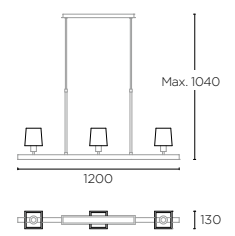

PAN 179-14



PAN 187-20



PAN 179-BY

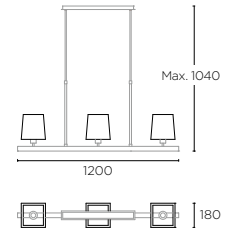

PAN 180-14



PAN 188-20



PAN 180-BY

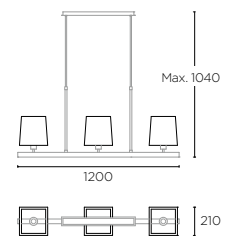

PAN 199-V7

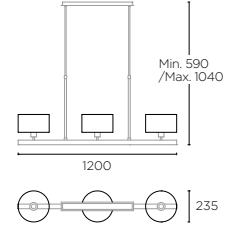



DECORATIVE | DRESS UP

SPICA

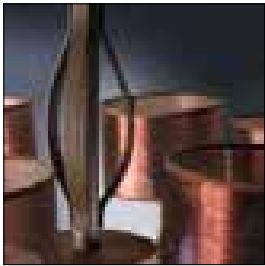

DRESS UP!



PAN 157-14



PAN 158-J6



PAN 157-BY



PAN 219-14

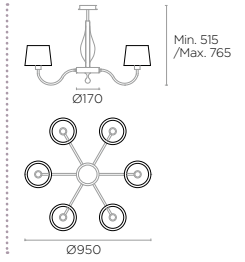

PAN 169-14

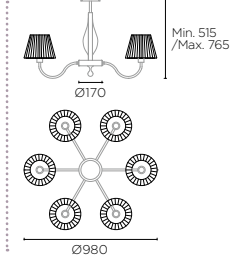

PAN 175-14



PAN 175-BY

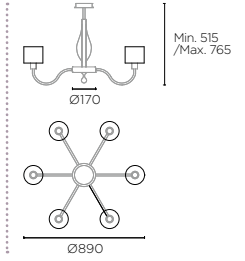

PAN 178-14



PAN 186-20



PAN 178-BY

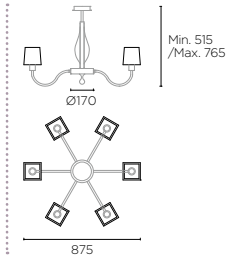

PAN 179-14



PAN 187-20



PAN 179-BY

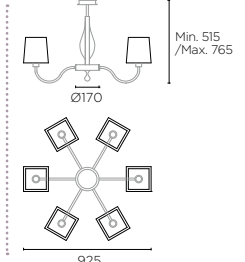

PAN 199-V7

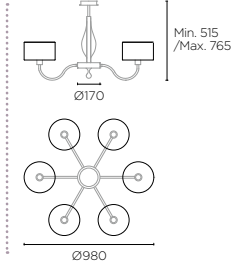

20-2013-Z6-82 + PAN

6 X E-27 MAX 60W

HALOGEN - FLUORESCENT - LED

RECOMMENDED MINI CANDLE 9W





SPICA



DRESS UP!



PAN 175-14



PAN 175-BY

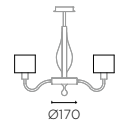

Min. 500
/Max. 750

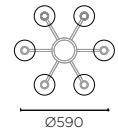

Ø590



PAN 157-14



PAN 158-J6



PAN 157-BY



PAN 219-14



Min. 720
/Max. 950

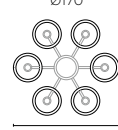

Ø737



PAN 178-14



PAN 186-20



PAN 178-BY

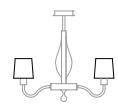

Min. 720
/Max. 950

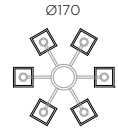

667



PAN 179-14



PAN 187-20



PAN 179-BY

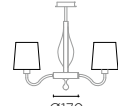

Min. 720
/Max. 950

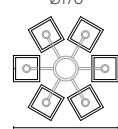

717



PAN 198-V7

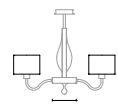

Min. 500
/Max. 750

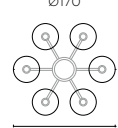

Ø720

20-2012-Z6-82 + PAN

6 X E-27 MAX 60W

HALOGEN - FLUORESCENT - LED

RECOMMENDED MINI CANDLE 9W



SPICA



25-2510-Z6-82 + PAN
 1 X E-27 MAX. 100W
 HALOGEN - FLUORESCENT - LED

DRESS UP!



PAN 159-14



PAN 160-J6



PAN 159-BY



863



440



PAN 181-14



PAN 189-20



PAN 181-BY

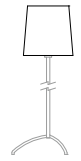

1800



440



PAN 182-14



PAN 182-T001



PAN 182-BY

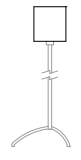

1710



440



PAN 183-14



PAN 183-T001



PAN 183-BY

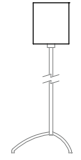

1740



440



PAN 184-14



PAN 185-J6



PAN 184-BY

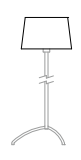

1710



440



PAN 220-V7

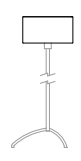

1680



440



PAN 221-V7

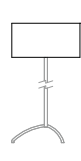

1670



440



DECORATIVE | DRESS UP



BALMORAL

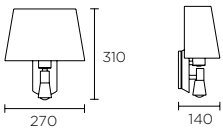

05-2814-81-05
05-2814-81-14
05-2814-81-20
 1 X E-27 MAX. 60W | L= 150 MM
 HALOGEN - FLUORESCENT - LED
 LED **CREE** 3W
 182 lm⁽⁹⁰⁾ | 2800K



TYRA

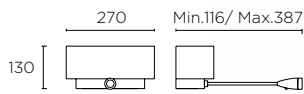

81 **05-4363-81-20** 
 1 X G24Q2 MAX. 18W
 LED CREE 3W
 182 lm⁽ⁿ⁾ | 3000K
W WHITE



BROOKLYN

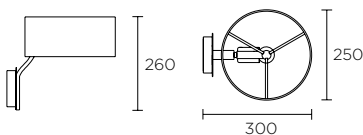

21 **05-2775-21-14 (S)**
 1 X E-27 MAX. 60W | Ø= 50MM L= 150 MM
 HALOGEN - FLUORESCENT - LED



DIDO



05-2015-14-14 | 05-2015-34-34

LED CREE 1 X 9W 560 lm⁽ⁿ⁾ | 3000K

LED CREE 1 X 1W 107 lm⁽ⁿ⁾ | 3000K

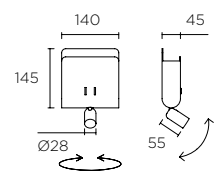

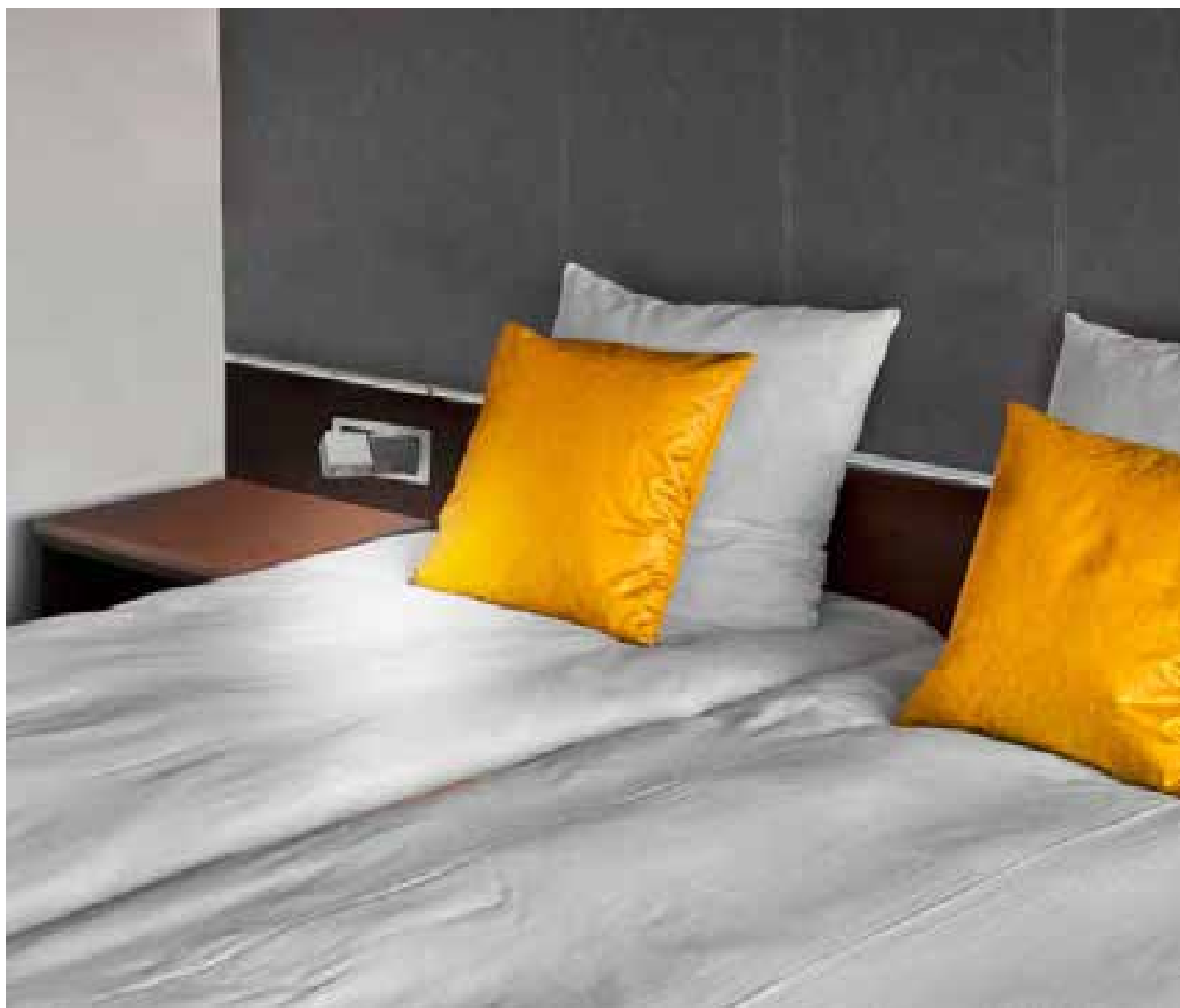

14	34	AL	RF 850°C	E	100-240V 50-60Hz	2x	⚡	⚡	⚡	Ⓜ	W WHITE
----	----	----	----------	---	------------------	----	---	---	---	---	---------

ESTAK

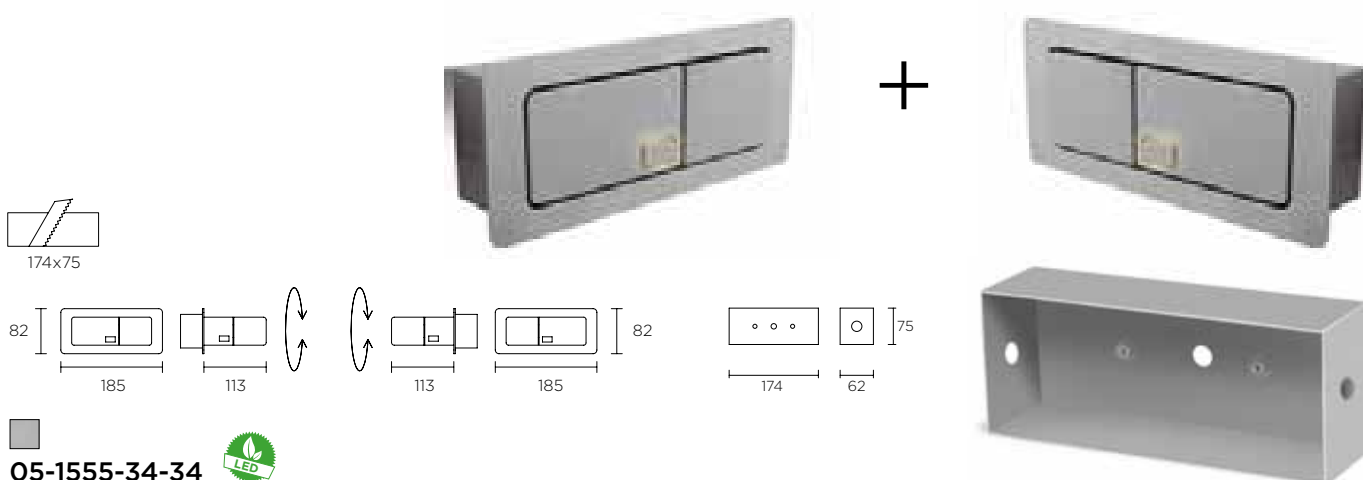

DECORATIVE | WALL & CEILING



05-1555-34-34 

LED CREE 3W
182 lm⁽ⁿ⁾ | 3000K



71-1653-34-34

Kit para empotrar en pared de obra
Recessing kit for brick wall
Kit pour encastrer au mur
Kit zum Einbauen im Mauerwerk
Kit per incasso a parete
Kit para encastrar em parede de obra
Набор для встроенного монтажа
Zestaw do montażu w ścianach z cegły

ON-OFF

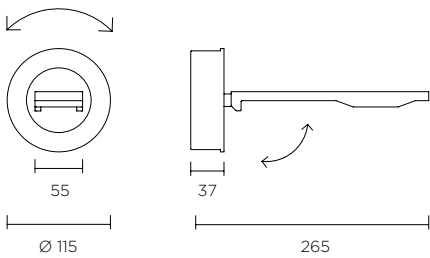

ON



OFF

05-0072-34-34

LED CREE 3W
182 lm⁽⁹⁾ | 2900K



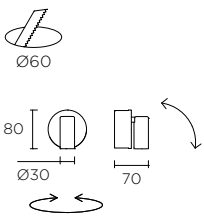

05-2706-81-81 | 05-2706-21-21 | 05-2706-E4-E4





LED CREE X 1W
107 lm⁽ⁿ⁾ | 3000K

81	21	E4	ST	AL		100-240V 50-60Hz							®		W WHITE
----	----	----	----	----	--	---------------------	--	--	--	--	--	--	---	--	------------

DRACO

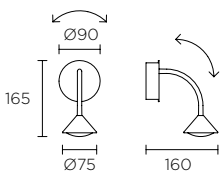
NEW



05-0486-14-M1 
LED CREE 3W
182 lm⁶⁰ | 3000K



BED



Min. 150/ Max. 530

Min. 35
Max. 450

Min. 170/ Max. 565

Min. 35
Max. 450



05-2830-34-34

LED CREE 3W
182 lm⁽ⁿ⁾ | 3000K



05-2831-34-34

LED CREE 3W
182 lm⁽ⁿ⁾ | 3000K



34

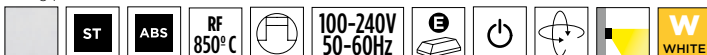

DECORATIVE | WALL & CEILING

BOOK

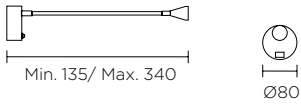

05-2838-21-21
 LED CREE 1W
 107 lm⁽ⁿ⁾ | 3000K

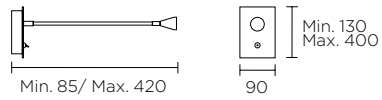

05-2837-21-21
 LED CREE 1W
 107 lm⁽ⁿ⁾ | 3000K

WALL

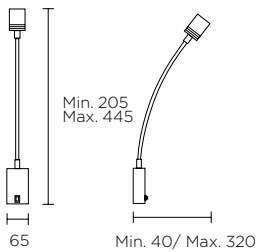

05-2845-21-21
 LED CREE 3W
 182 lm⁽ⁿ⁾ | 3000K

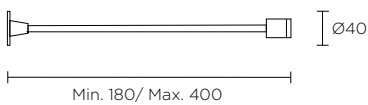

05-2835-54-54
 LED CREE 1,2W
 107 lm⁽ⁿ⁾ | 3000K



LLIT



DECORATIVE | WALL & CEILING

Ø 90

515

Min. 30
Max. 415

485

Ø 120

Max. 360

446-NS
30 LEDs X 0.073W = 2.2W
242 lm⁽ⁿ⁾ | 6000K

10-1788-81-81
30 LEDs X 0.073W = 2.2W
242 lm⁽ⁿ⁾ | 6000K

NS

ST

RF
850°C

E

100-240V
50-60Hz

⏻

⚡

2

C
WHITE

ROOMIE

NEW

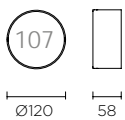

05-2753-14-M2
LED CREE 1W
107 lm⁽ⁿ⁾

FILTROS INCLUIDOS | SIGNAL FILTERS INCLUDED | FILTRES DE SIGNALISATION FOURNIS
FILTER FÜR SIGNALISIERUNG INKLUSIVE | FILTRI DI SEGNALAZIONE INCLUSI | SINALIZAÇÃO, INCLUINDO FILTROS
ФИЛЬТРЫ С ОБОЗНАЧЕНИЯМИ В КОМПЛЕКТЕ | FILTRY SYGNAŁÓW W KOMPLECIE





SIENA LED

NEW

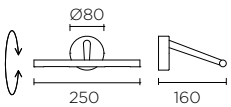

05-1577-E4-M2 | 05-1577-21-M2 | 05-1577-81-M2

LED 12 X 0,2W = 2,4W
265 lm⁽ⁿ⁾ | 3000 K

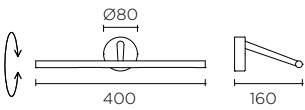

05-1611-E4-M2 | 05-1611-21-M2 | 05-1611-81-M2

LED 18 X 0,2W = 3,6W
400 lm⁽ⁿ⁾ | 3000 K

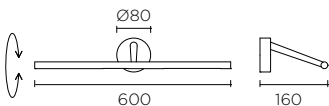

05-2897-E4-M2 | 05-2897-21-M2 | 05-2897-81-M2

LED 30 X 0,23W = 7W
700 lm⁽ⁿ⁾ | 3000 K

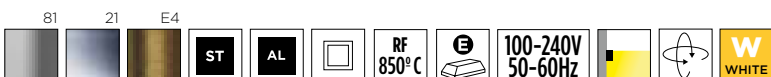

SIENA



DECORATIVE | WALL & CEILING

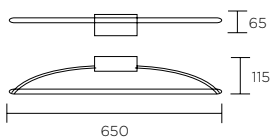

280-NS

1 X T5 13W

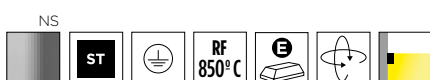

LIA LED

NEW

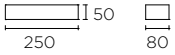
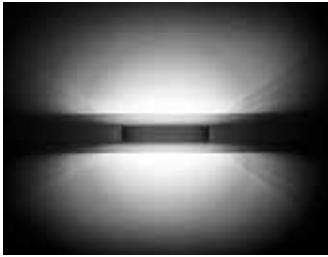

05-2703-81-81 | 05-2703-21-21 | 05-2703-14-14

LED 12 X 0,3W = 3,5W 356 lm^(N)
3000K

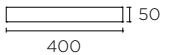

05-2704-81-81 | 05-2704-21-21 | 05-2704-14-14

LED 24 X 0,3W = 7W 713 lm^(N)
3000K

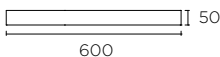

05-2705-81-81 | 05-2705-21-21 | 05-2705-14-14

LED 36 X 0,3W = 10,5W 1070 lm^(N)
3000K



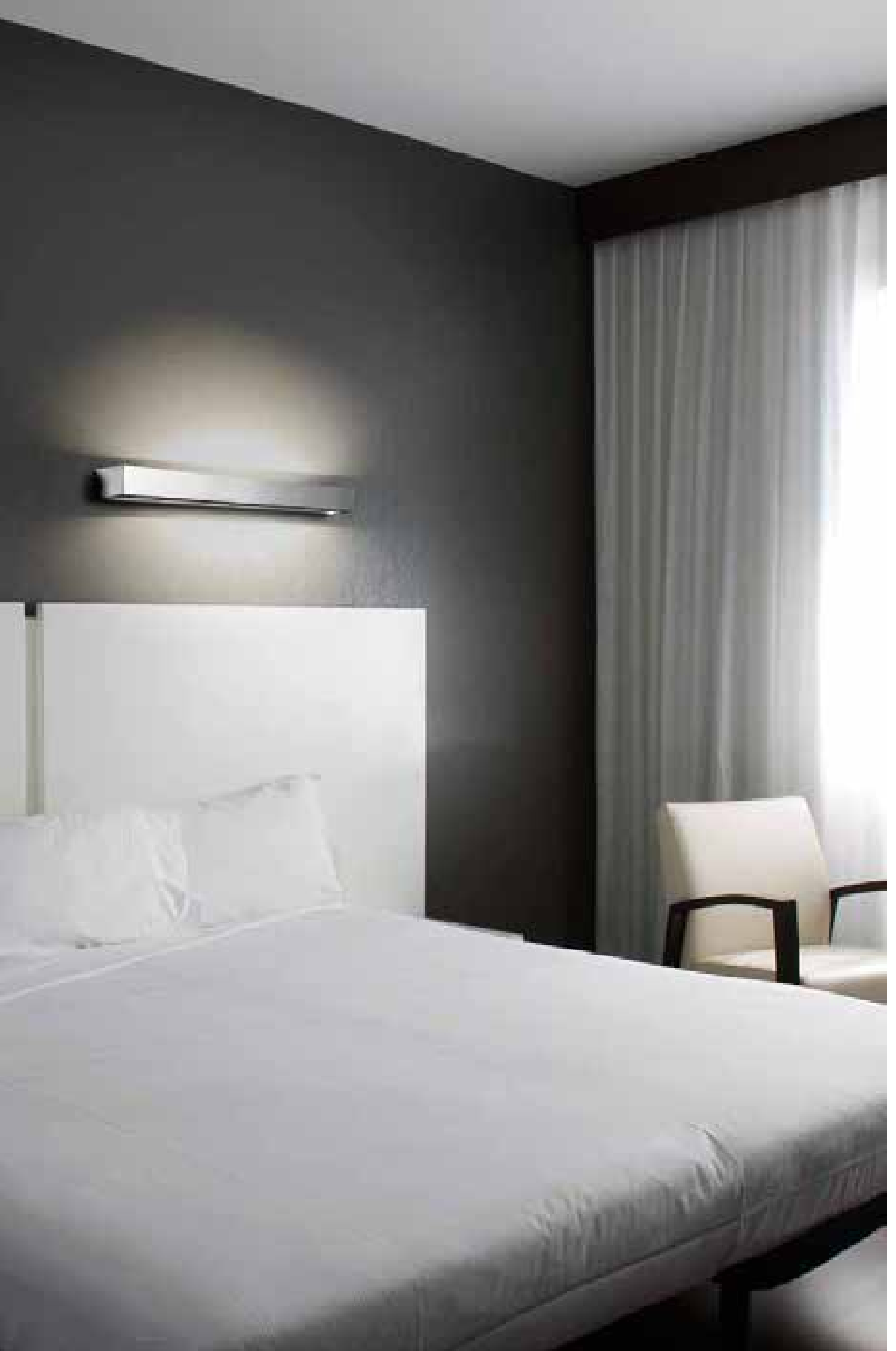

SATURN

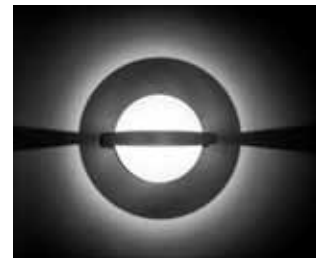

NEW

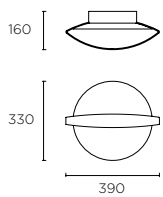

15-2021-14-14
LED SHARP 18W
1800 lm^(N) | 3000K

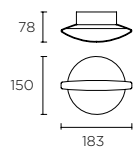

05-2233-14-14
LED CITIZEN 4W
380 lm^(N) | 3000K

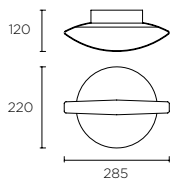

15-2020-14-14
LED SHARP 9W
855 lm^(N) | 3000K



14





DECORATIVE | WALL & CEILING

KUB

NEW

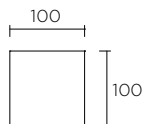

05-3220-14-14

LED CREE 4 X 1,025W = 4,1W
428 lm^(ND) | 3000K

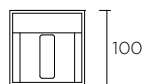
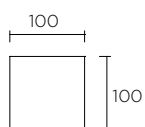
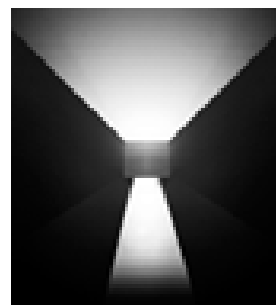
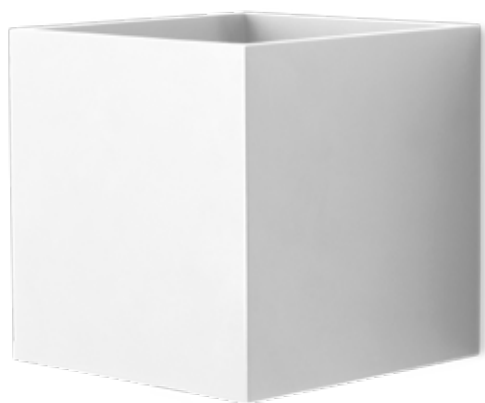

05-3220-25-25

LED CREE 4 X 1,025W = 4,1W
428 lm^(ND) | 3000K

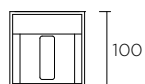
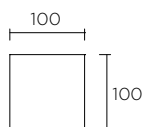
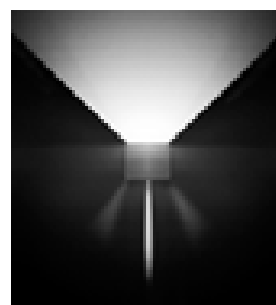

05-3220-34-34

LED CREE 4 X 1,025W = 4,1W
428 lm^(ND) | 3000K

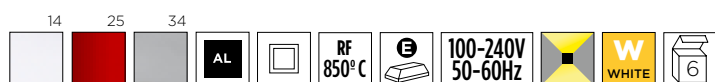

JET

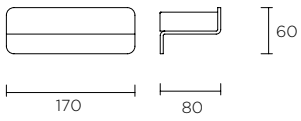

05-0069-14-14
 LED **CITIZEN** X 4W
 488 lm^(N) | 3000K



05-0533-14-14
 1 X G9 MAX. 40W
 HALOGEN - FLUORESCENT - LED

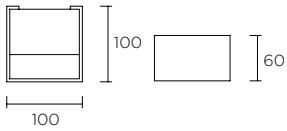

05-0071-14-14
 LED **CREE** X 3W
 182 lm^(N) | 3000K

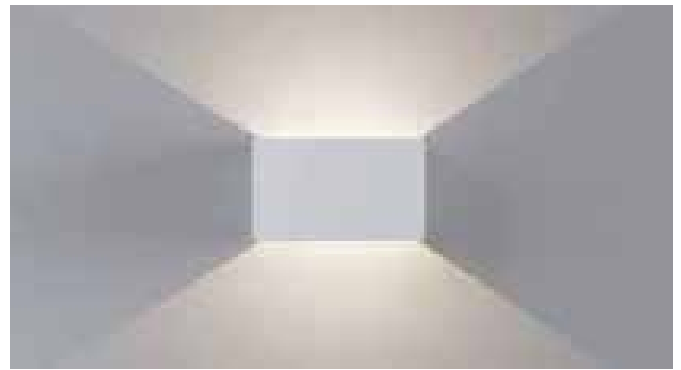

14

BRICK

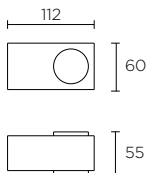

05-4427-S2-M1
 LED **CREE** 2 X 3W = 6W
 364 lm^(N) | 3000k



S2



OVAL

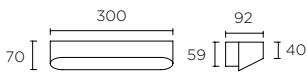
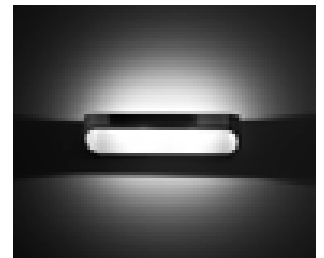

05-2019-S2-14 | 05-2019-14-14

LED **CITIZEN** 2 X 4W = 8W
820 lm⁽ⁿ⁾ | 3000K

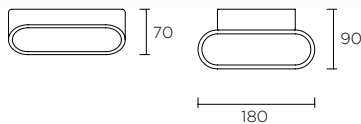

05-0070-S2-14 | 05-0070-14-14

LED **CITIZEN** 1 LED X 4W
488 lm⁽ⁿ⁾ | 3000K

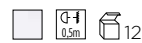
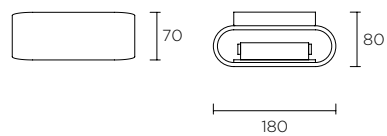

05-0534-14-14

1 X R7S MAX. 100W





SPOT



Ø105 30

05-0487-14-54

LED CREE 3W
 182 lm⁽ⁿ⁾ | 3000K



Ø105 30



05-0487-05-54

LED CREE 3W
 182 lm⁽ⁿ⁾ | 3000K



GES

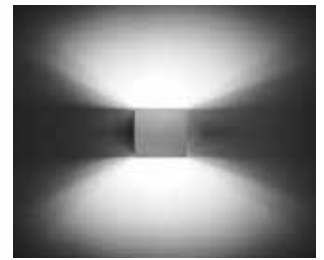
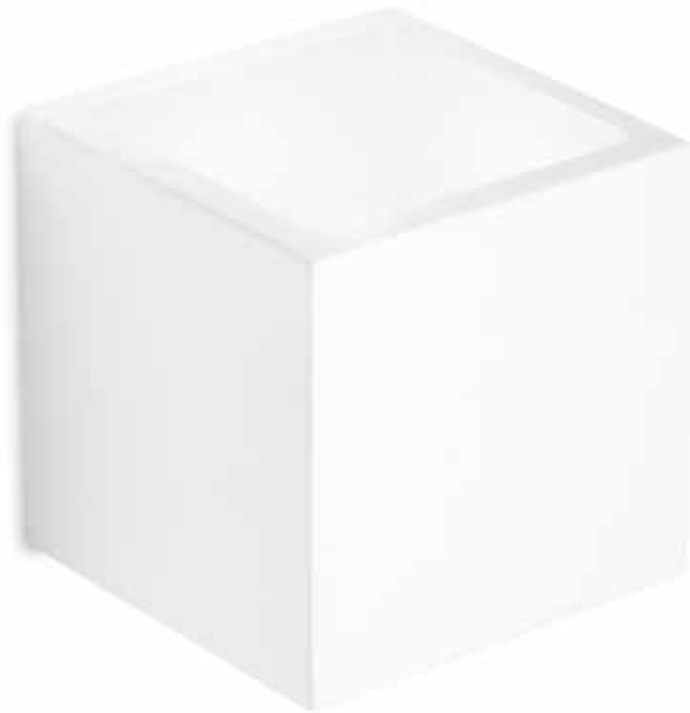





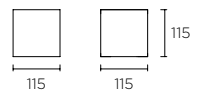

05-1794-14-14
 1 X G9 MAX. 40W

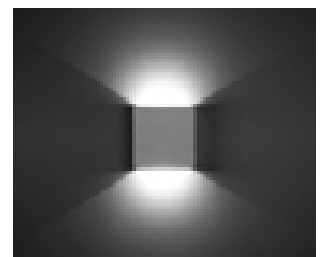

DECORATIVE | WALL & CEILING









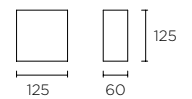

05-1798-14-14 | 05-1798-D9-D9 | 05-1798-D8-D8

LED CREE 2 X 2W = 4W
 330 lm⁽ⁿ⁾ | 3000 K

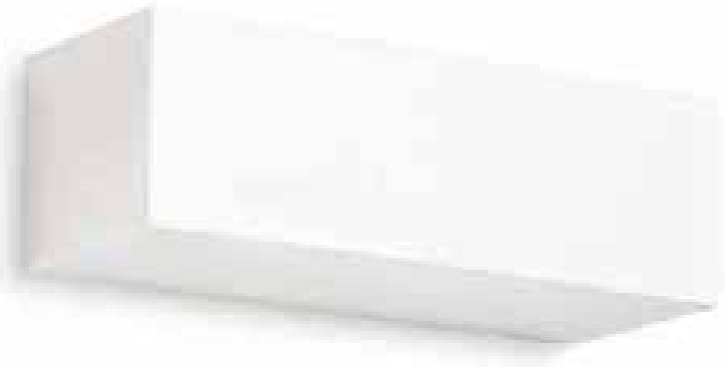

GES



05-1793-14-14

1 X E-14 MAX. 40W | L= 129 MM Ø= 45 MM
HALOGEN - FLUORESCENT - LED

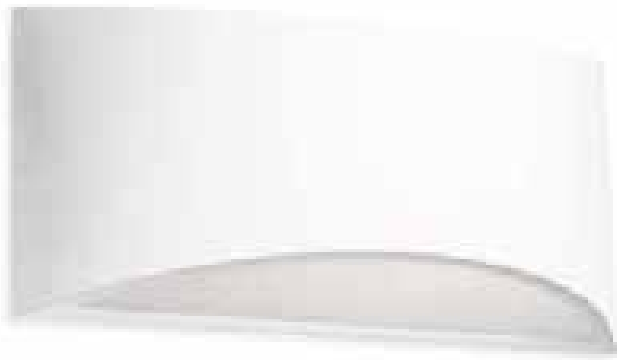
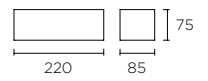

05-1796-14-14

1 X E-14 MAX. 40W | L= 129 MM Ø= 45 MM
HALOGEN - FLUORESCENT - LED

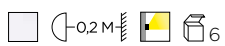
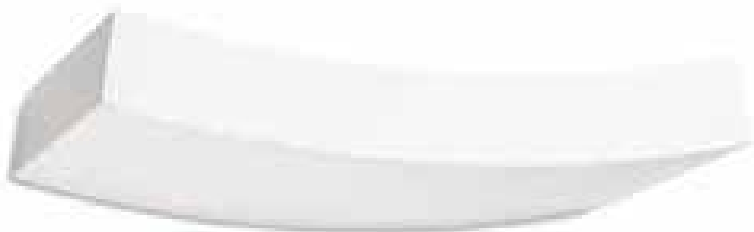
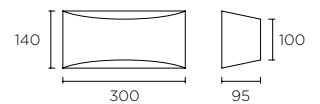

05-1795-14-14

1 X R7S MAX. 100W L = 78 MM

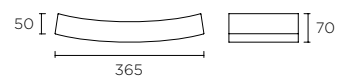



LIA



□ IP 44

05-4401-14-B8
 1 X E-27 MAX. 60W | Ø= 70 MM L= 160 MM
 HALOGEN - FLUORESCENT - LED

□ IP 20

05-4401-BX-B8
 1 X E-27 MAX. 60W | Ø= 70 MM L= 160 MM
 HALOGEN - FLUORESCENT - LED



NEMESIS



DECORATIVE | WALL & CEILING

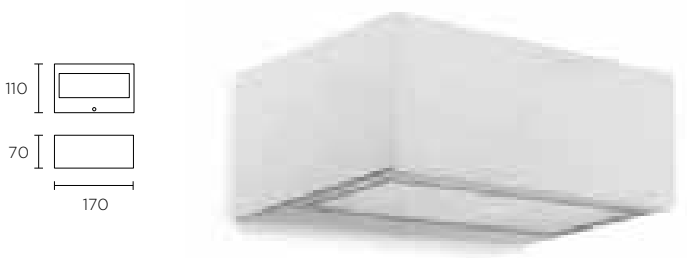

05-9177-14-B8

1 X R7S L = 78 MAX. 100W



05-4402-BX-B8

1 X R7S L = 78 MAX. 100W

71-8969-00-00

Reactancia para:

Ballast for:

Ballast pour:

Blindwiderstand für:

Reattanza per :

Reactància para :

активное сопротивление для :

Reaktancja dla :

PL-G24d-113W 230V



BREMEN

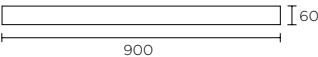

284-CR
2 X T5 21W



HALF



DECORATIVE | WALL & CEILING

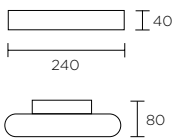

492-CR

1 X R7S L = 118 MAX. 150W
OSRAM INCLUDED

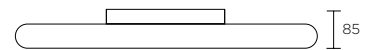
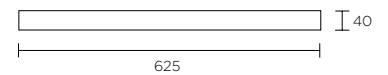
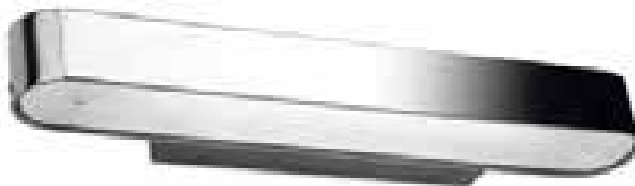

493-CR

1 X T5 14W



PRACTIC

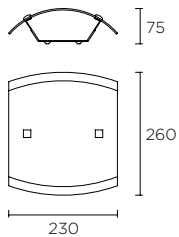

05-0517-21-E9

1 X E-27 MAX. 100W | Ø= 60 MM L= 200 MM
HALOGEN - FLOURESCENT - LED

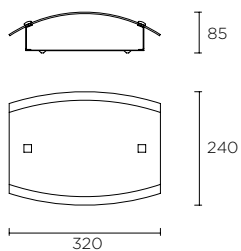

05-0518-21-E9

2 X E-27 MAX. 60W | Ø= 60 MM L= 200 MM
HALOGEN - FLUORESCENT - LED

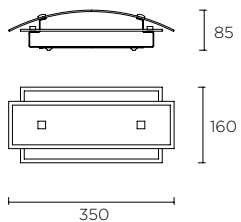

05-0519-21-E9

1 X E-27 MAX. 100W | Ø= 60 MM L= 190 MM
HALOGEN - FLUORESCENT - LED

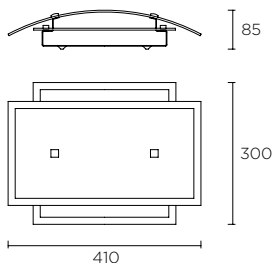

05-0530-21-E9

2 X E-27 MAX. 60W | Ø= 60 MM L= 190 MM
HALOGEN - FLUORESCENT - LED



21



NIZA

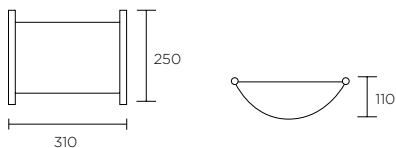

274-NS

2 X E-27 MAX. 60W | Ø= 60 MM L= 160 MM
HALOGEN - FLUORESCENT - LED

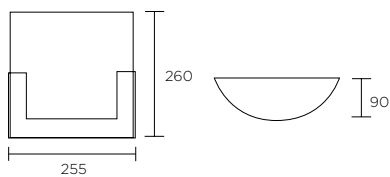

505-NS

2 X E-27 MAX. 60W | Ø= 60 MM L= 190 MM
HALOGEN - FLUORESCENT - LED

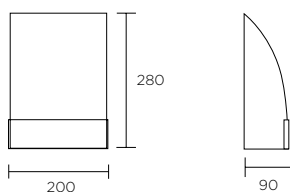

506-CR

1 X E-27 MAX. 60W | Ø= 60 MM L= 120 MM
HALOGEN - FLUORESCENT - LED



LUGO

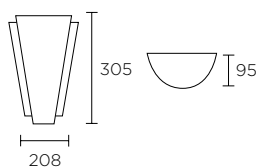

482-CR

1 X E-27 MAX. 100W | Ø= 80 MM L= 130 MM
HALOGEN - FLUORESCENT - LED

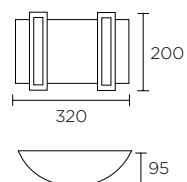

479-CR

2 X E-27 MAX. 60W | Ø= 60 MM L= 130 MM
HALOGEN - FLUORESCENT - LED

CR - Y2



GLASS



DECORATIVE | WALL & CEILING

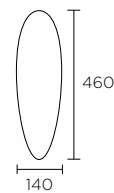
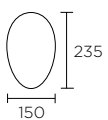

444-BL

1 X E-27 MAX. 60W | Ø= 70 MM L= 130 MM
HALOGEN - FLUORESCENT - LED



445-BL

1 X E-27 MAX. 60W | Ø= 70 MM L= 130 MM
HALOGEN - FLOURESCENT - LED

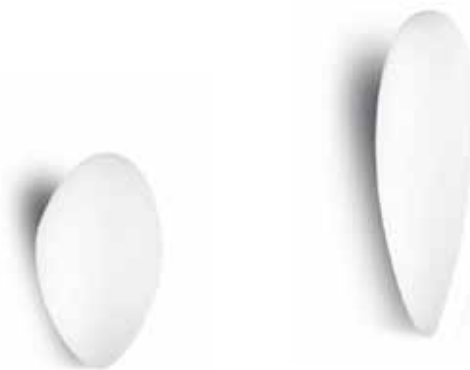

SUNNY

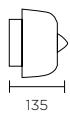
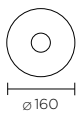

510-CR

1 X E-14 MAX. 40W DECOR SILVER 2700K WARM WHITE **OSRAM INCLUDED**
HALOGEN - FLUORESCENT - LED



ALU



DECORATIVE | WALL & CEILING

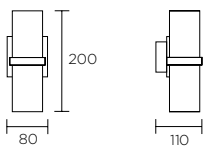







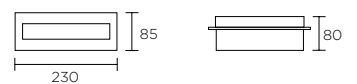
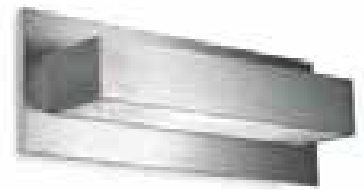
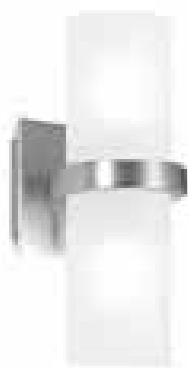

456-AL
 2 X G9 MAX. 60W
 OSRAM INCLUDED





443-AL
 1 X R7S L = 118 MAX. 150W OSRAM INCLUDED



VESPA

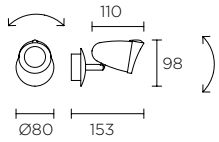

05-0848-16-21

1 X GU10 LED 6W

RECOMMENDED ACT-FLL-025

LED

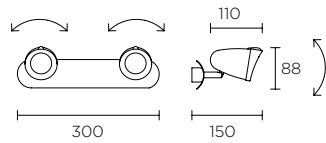

05-0849-16-21

2 X GU10 LED 6W

RECOMMENDED ACT-FLL-025

LED

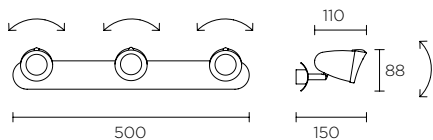

05-0850-16-21

3 X GU10 LED 6W

RECOMMENDED ACT-FLL-025

LED



21-16

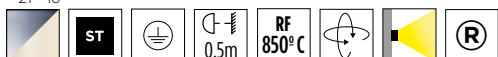

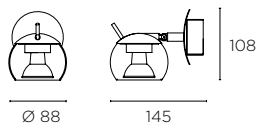

05-4351-21-37

1 X GU10 MAX. 50W
HALOGEN - LED

RECOMMENDED ACT-FLL-025

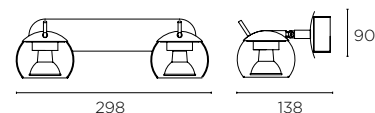

05-4352-21-37

2 X GU10 MAX. 50W
HALOGEN - LED

RECOMMENDED ACT-FLL-025

21



TRINITY

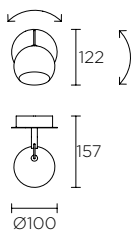

05-1513-21-21

1 X GU10 LED 6W

LED

RECOMMENDED ACT-FLL-025

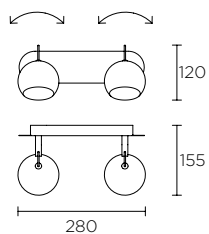

05-1514-21-21

2 X GU10 LED 6W

LED

RECOMMENDED ACT-FLL-025





WOOD

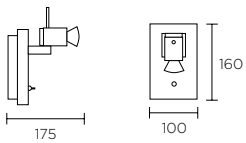

410-CR

1 X GU10 MAX. 50W OSRAM INCLUDED
 HALOGEN - LED
 RECOMMENDED ACT-FLL-025

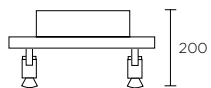
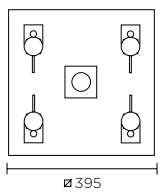

415-CR

5 X GU10 MAX. 50W OSRAM INCLUDED
 HALOGEN - FLOURESCENT -LED
 RECOMMENDED ACT-FLL-025

CR - J6



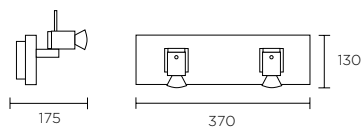

411-CR

2 X GU10 MAX. 50W OSRAM INCLUDED

HALOGEN - LED

RECOMMENDED ACT-FLL-025

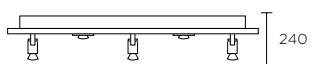
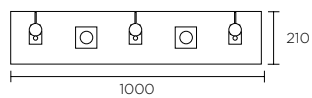

416-CR



5 X GU10 MAX. 50W OSRAM INCLUDED

HALOGEN - LED

RECOMMENDED ACT-FLL-025

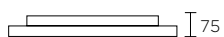
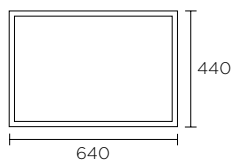

TOLEDO





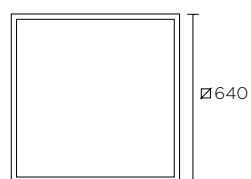



15-2906-S2-M1
 2 X G11 55W



15-2907-S2-M1
 3 X G11 55W







15-2938-S2-M1
 LED 324 X 0,18W = 58W
 5180 lm⁽ⁿ⁾ | 3000K







434-AL
 2 X 2G11 40W



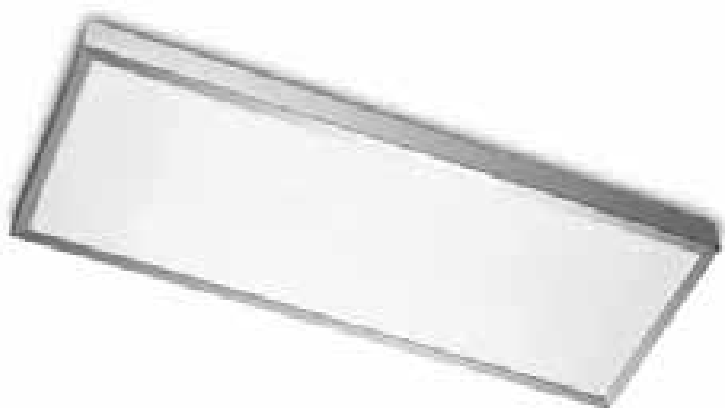





15-2939-S2-M1
 LED 162 X 0,18W = 29W
 2565 lm⁽ⁿ⁾ | 3000K

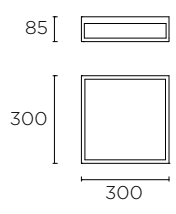

NEW



η
HIGH





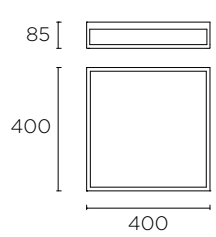





15-2936-S2-M1
 LED 108 X 0,18W = 19W
 1710 lm⁽ⁿ⁾ | 3000K

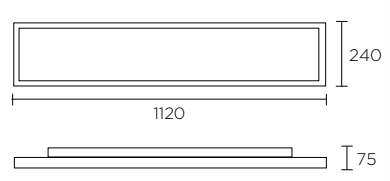

15-2937-S2-M1
 LED 162 X 0,18W = 29W
 2590 lm⁽ⁿ⁾ | 3000K



15-2940-S2-M1
 LED 216 X 0,18W = 38W
 3420 lm⁽ⁿ⁾ | 3000K

S2

									
---	---	---	---	---	---	---	---	---	---



DECORATIVE | WALL & CEILING

PRISMA



15-4689-14-B4 | 15-4689-S2-B4
 2 X E-27 PL ELEC. MAX. 18W
 FLUORESCENT - LED



⊞ **15-4690-14-B4 | 15-4690-S2-B4**
 3 X E-27 PL ELEC. MAX. 18W
 FLUORESCENT - LED

⊞
S2
AL
GLA DIF
⏚
IP 23
RF 850°C
⚡
®

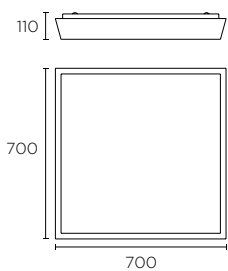

15-4692-14-M1 | 15-4692-S2-M1

3 X 2G11 55W

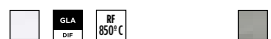
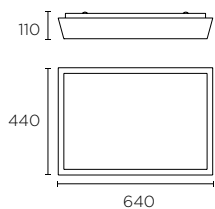

15-4691-14-B4 | 15-4691-S2-B4

2 X 2G11 55W



RAS

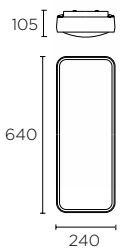

15-4686-14-M1 | 15-4686-S2-M1

1 X 2G11 55W

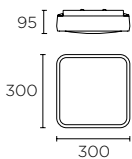

15-4685-14-M1 | 15-4685-S2-M1

2 X E-27 PL ELEC. MAX. 18W



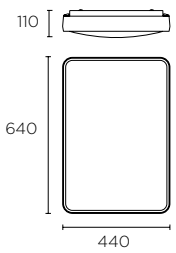

15-4687-14-M1 | 15-4687-S2-M1
2 X 2G11 55W



DECORATIVE | WALL & CEILING

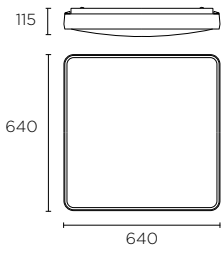

15-4688-14-M1 | 15-4688-S2-M1
3 X 2G11 55W

14 S2

--	--	--	--	--	--	--	--	--	--

ALPEN

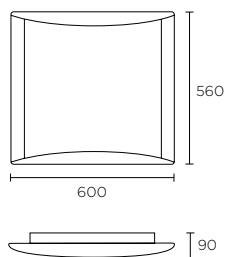

15-2905-34-M1
4 X 2G11 24W

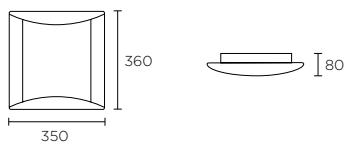

332-GR
2 X G24q3 26W







331-GR
 2 X 2G11 40W

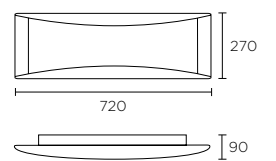

CLIP

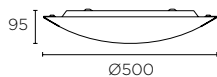

15-1522-21-E9
LED 91 X 0,2W = 18W
1800 Lm | 3000K



15-4684-21-E9
3 X E-27 MAX. 40W
HALOGEN - FLUORESCENT - LED

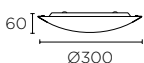

15-1521-21-E9
LED 70 X 0,2W = 14W
1400 Lm | 3000K



15-4682-21-E9
2 X E-27 MAX. 25W
HALOGEN - FLUORESCENT - LED

21



ROUND



DECORATIVE | WALL & CEILING

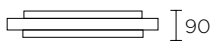
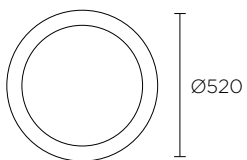

514-GR

1 x T5 TUBULAR 22W
1 x T5 TUBULAR 55W
FLUORESCENT - LED



GR

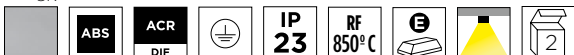

AUDREY

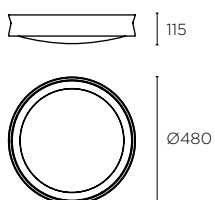

15-4336-14-M1
3 X E-27 MAX. 25W
HALOGEN - FLUORESCENT - LED



OSLO



DECORATIVE | WALL & CEILING

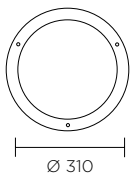

271-NS

1 X R7S L = 78 MAX. 100W OSRAM INCLUDED



FLEX

NEW

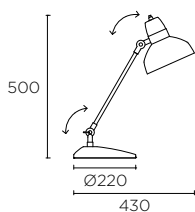

10-1530-21-14 | 10-1530-21-05

1 X E-27 MAX. 60W | Ø= 70 MM L= 130 MM

HALOGEN - FLUORESCENT - LED

RECOMMENDED MINI GLOBE 11W

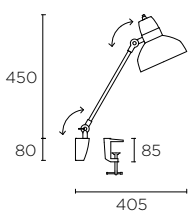

05-1530-21-14 | 05-1530-21-05

1 X E-27 MAX. 60W | Ø= 70 MM L= 130 MM

HALOGEN - FLUORESCENT - LED

RECOMMENDED MINI GLOBE 11W

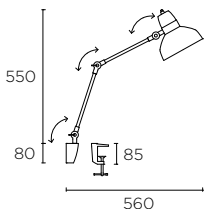

05-1531-21-14 | 05-1531-21-05

1 X E-27 MAX. 60W | Ø= 70 MM L= 130 MM

HALOGEN - FLUORESCENT - LED

RECOMMENDED MINI GLOBE 11W

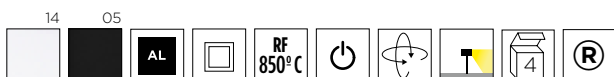

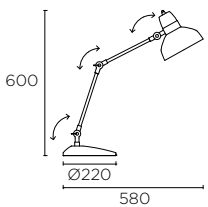
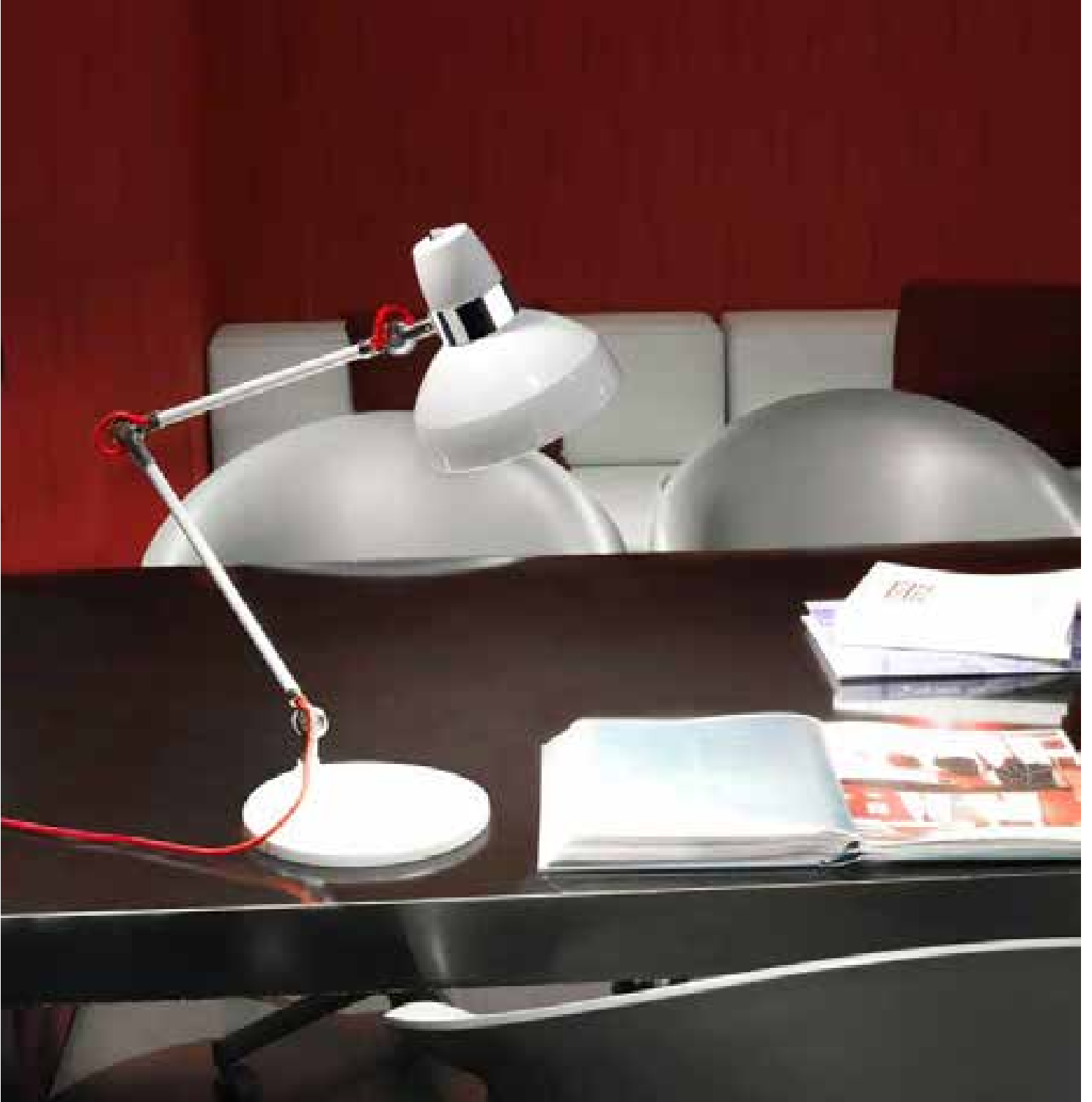

10-1531-21-14 | 10-1531-21-05
 1 X E-27 MAX. 60W | Ø= 70 MM L= 130 MM
 HALOGEN - FLUORESCENT - LED
 RECOMMENDED MINI GLOBE 11W



WAVE



10-0392-21-14 | 10-0392-21-25
 1 X E-27 PL ELEC. MAX. 18W | Ø= 60 MM L= 120 MM
 FLUORESCENT - LED
RECOMMENDED MINI GLOBE 11W

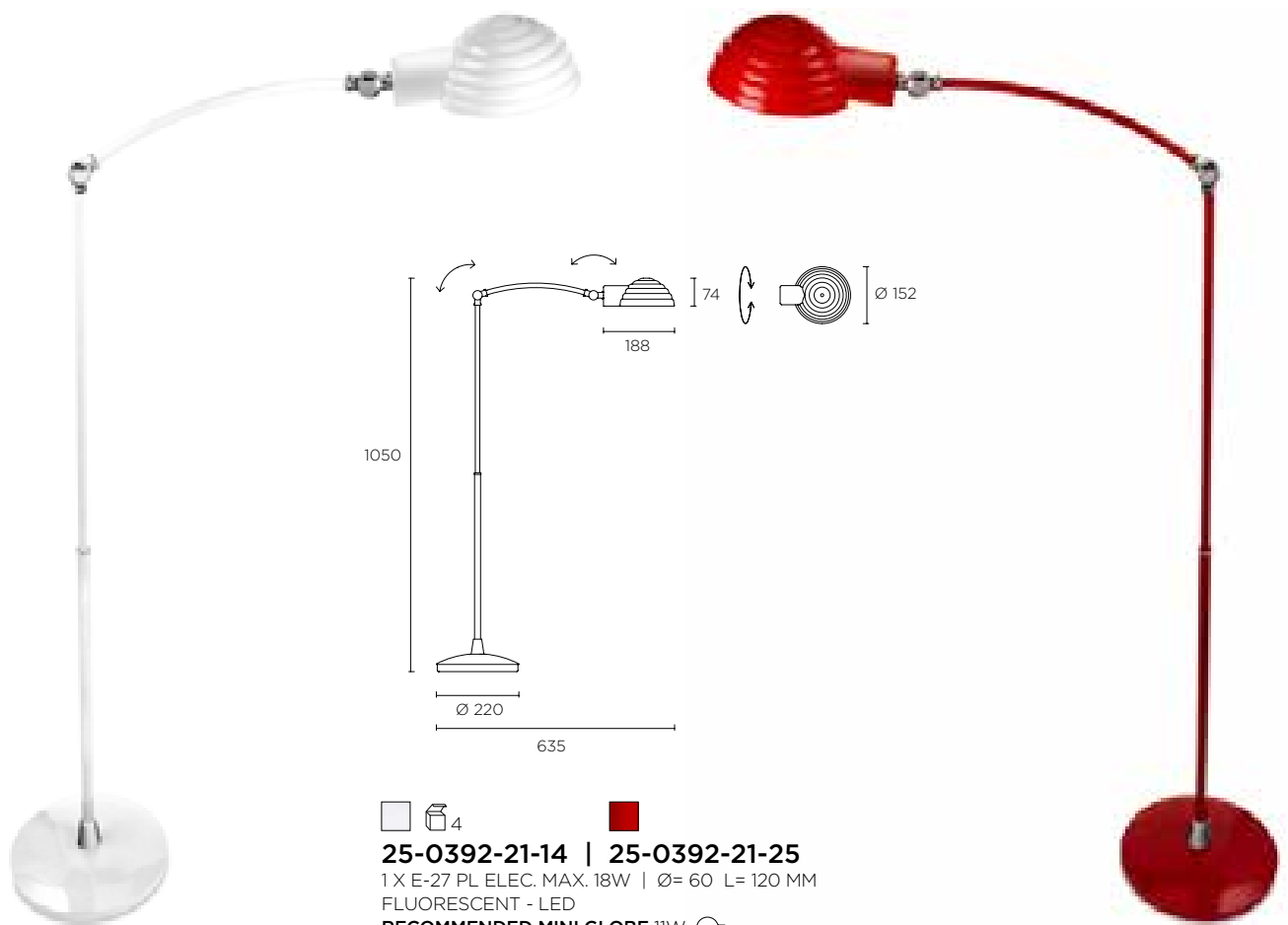

25-0392-21-14 | 25-0392-21-25
 1 X E-27 PL ELEC. MAX. 18W | Ø= 60 L= 120 MM
 FLUORESCENT - LED
RECOMMENDED MINI GLOBE 11W



WAVE

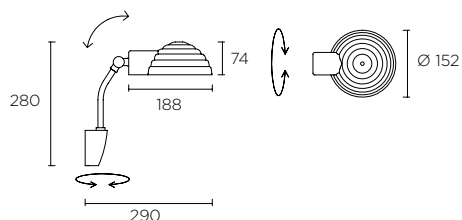

05-0392-21-14 | 05-0392-21-25
 1 X E-27 PL ELEC. MAX. 18W | Ø= 60 L= 120 MM
 FLUORESCENT - LED
RECOMMENDED MINI GLOBE 11W



HOLMES

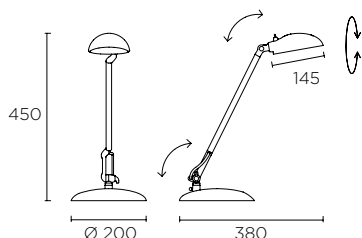

10-0231-34-05
 LED 50 X 0,1W = 5W
 350 lm⁽ⁿ⁾ | 2900K



QUEEN

NEW

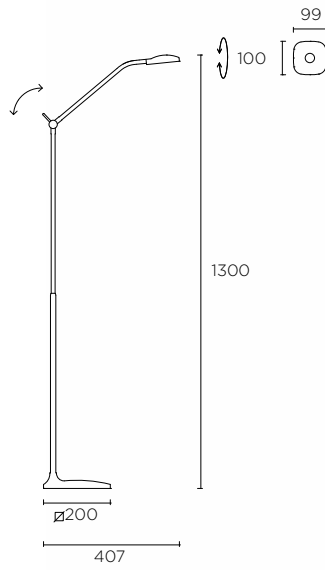

25-3273-21-05 | 25-3273-E4-Y2
 LED CITIZEN 6,9W
 434 lm^(N) | 3000K

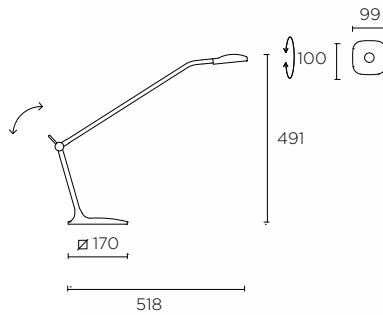

10-3273-21-05 | 10-3273-E4-Y2
 LED CITIZEN 6,9W
 434 lm^(N) | 3000K



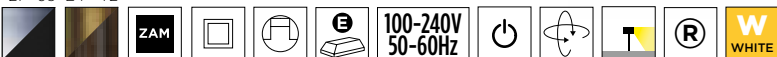

21 - 05 E4 - Y2



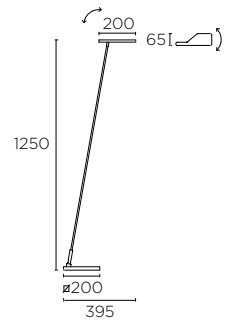
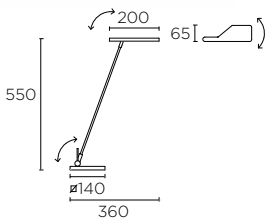

ELVA



10-1523-21-21
 LED **CITIZEN** 6W
 434 lm⁽ⁿ⁾ | 3000K

25-1523-21-21
 LED **CITIZEN** 6W
 434 lm⁽ⁿ⁾ | 3000K







DECORATIVE | DESK & FLOOR

JAZZ

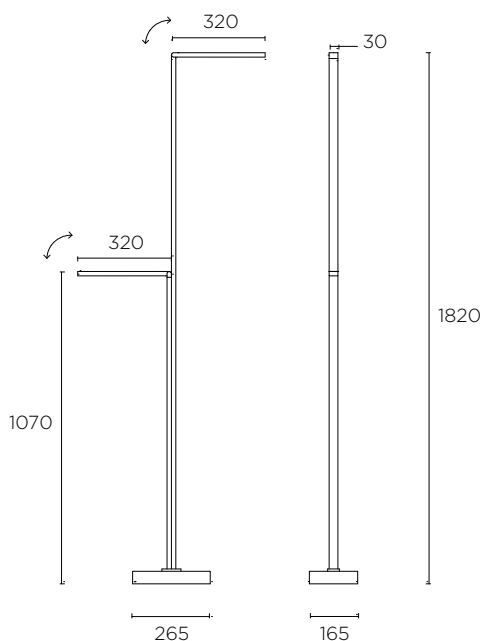
NEW





25-3216-14-M3
LED **CREE** 9 X 2,2 = 20W
1540 lm⁽ⁿ⁾ | 3000K
LED **CREE** 2,2W
170 lm⁽ⁿ⁾ | 3000K



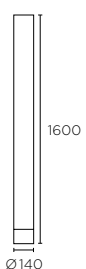

DECORATIVE | DESK & FLOOR

ABERDEEN



Ø140

337-AL

1 X E-27 PAR 30 MAX. 75W
HALOGEN - FLUORESCENT - LED



EXTEND



ON / OFF DIMMER



DECORATIVE | DESK & FLOOR

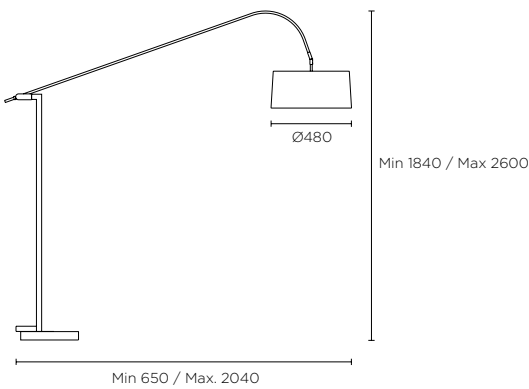

25-2860-Y2-05 | 25-2860-Y2-14

3 X E-27 MAX. 60W
HALOGEN - FLUORESCENT - LED



PING

NEW

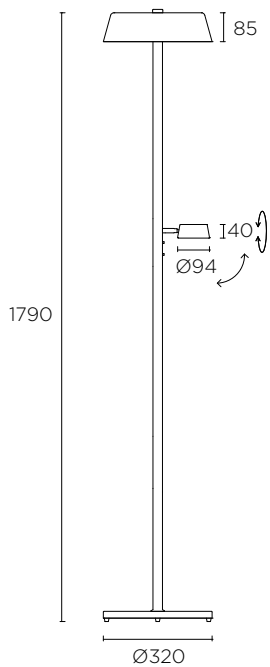

25-3215-14-M1

2 X E-27 PL ELEC. MAX. 18W | Ø= 60 MM L= 130 MM

FLUORESCENT - LED

LED **CREE** 2,2W | 3000K

182 lm^(N)

14

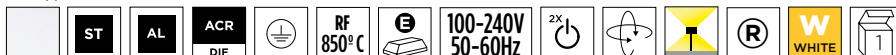

CRETA

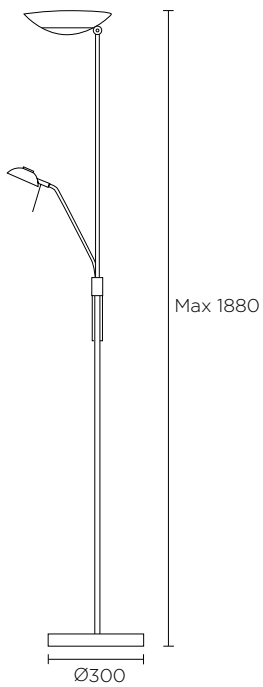

127-NS

1 X R7S L = 118 MAX. 300W

1 X GY 6,35 50W 12V

INCLUDED



DECORATIVE | DESK & FLOOR

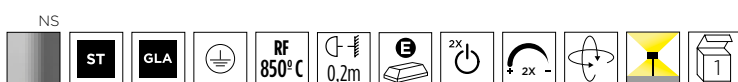

MEMPHIS

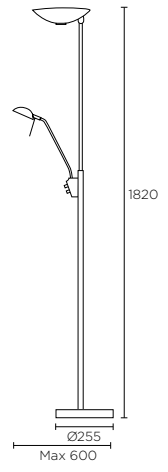
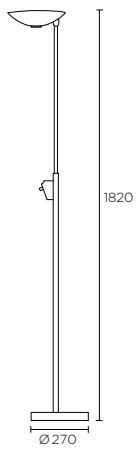

247-NS
1 X R7S L = 118 MAX. 300W
INCLUDED

248-NS
1 X R7S L = 118 MAX. 300W
1 X GY 6,35 50W 12V
INCLUDED

NS

--	--	--	--	--	--	--	--	--	--





BATHROOM LIGHTING

LA ILUMINACIÓN EN LA ZONA DE BAÑO | BATHROOM LIGHTING | L'ÉCLAIRAGE DANS LA SALLE DE BAINS | BELEUCHTUNG IM BAD | L'ILLUMINAZIONE NELL'AREA DEL BAGNO | ILUMINAÇÃO DA CASA DE BANHO | ОСВЕЩЕНИЕ В ВАННОЙ ОБЛАСТЬ | OŚWIETLENIE ŁAZIENKOWE



DECORATIVE | BATH

ZONA 1 Protección contra posibles penetraciones de agua. Se requiere IP45 (IPX5) o superior.

ZONA 2 Protección contra posibles proyecciones de agua. Se requiere IP44 (IPX4) o superior.

ZONA 3 Sin restricciones en esta zona.

ZONE 1 Protection against direct water jets. IP45 (IPX5) or above required.

ZONE 2 Protection from water splashing. IP44 (IPX4) or above required.

ZONE 3 No-restriction zone.

ZONE 1 Protection contre le risque de pénétration d'eau. Indice IP45 (IPX5) ou supérieur exigé.

ZONE 2 Protection contre le risque de projection d'eau. Indice IP44 (IPX4) ou supérieur exigé.

ZONE 3 Aucune restriction dans cette zone.

ZONE 1 Schutz gegen Wassereintritt. Schutzklasse IP45 (IPX5) oder höher erforderlich.

ZONE 2 Schutz gegen Wasserspritzer. Schutzklasse IP44 (IPX4) oder höher erforderlich.

ZONE 3 Zone ohne Beschränkungen

ZONA 1 Protezione da possibili infiltrazioni d'acqua. Necessario IP45 (IPX5) o superiore.

ZONA 2 Protezione da possibili schizzi d'acqua. Necessario IP44 (IPX4) o superiore.

ZONA 3 Nessuna limitazione in questa zona.

ZONA 1 Proteção contra possíveis penetrações de água. Requer IP45 (IPX5) ou superior.

ZONA 2 Proteção contra possíveis projeções de água. Requer IP44 (IPX4) ou superior.

ZONA 3 Sem restrições nesta zona.

ЗОНА 1 Защита от возможного попадания воды. Обладает IP45 (IPX5) или выше.

ЗОНА 2 Защита от возможного попадания воды. Обладает IP44 (IPX4) или выше.

ЗОНА 3 Без ограничения на данной территории.

STREFA 1 Ochrona przed penetracją wody. Wymagane IP45 (IPX5) lub wyższe.

STREFA 2 Ochrona przed rozpryskiem wody. Wymagane IP44 (IPX4) lub wyższe.

STREFA 3 Brak wymagań IP.

CONCEPT

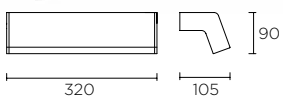

O5-4698-21-M1
2 x T5 8W

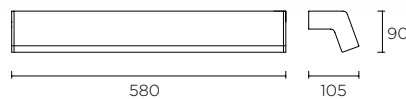

O5-4699-21-M1
2 x T5 14W

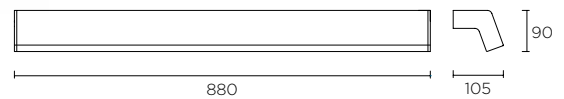

O5-4700-21-M1
2 x T5 21W

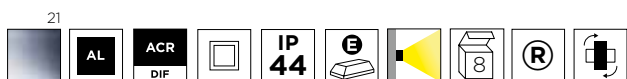

BELYSA



DECORATIVE | BATH

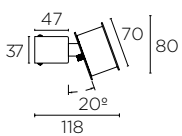

IP44

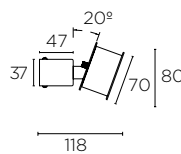

IP20

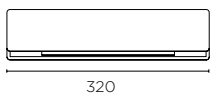

05-4361-21-05
1 x 2G11 18W

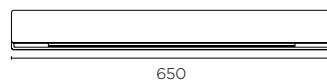

05-4362-21-05
1 x 2G11 40W

21

MAKE UP



■  4
489-AL
 5 x G9 MAX. 60W
 40W OSRAM INCLUDED

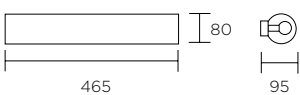

■  6
488-AL
 3 x G9 MAX. 60W
 40W OSRAM INCLUDED



SKARA



DECORATIVE | BATH

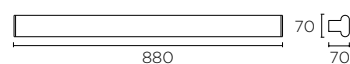

O5-4358-21-M1
1 x T5 21W

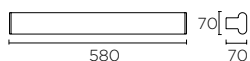

O5-4357-21-M1
1 x T5 14W

21

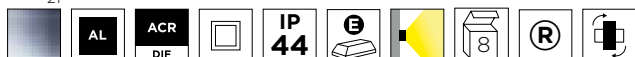

TOILET



457-CR
1 x 2G11 24W
2700k WARM WHITE INCLUDED

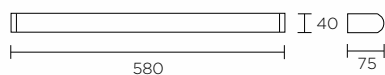
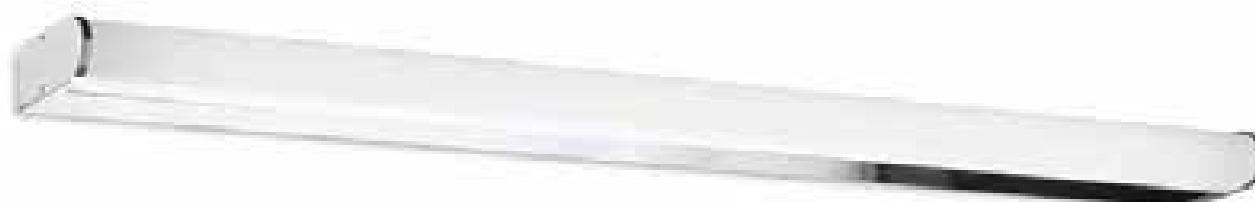
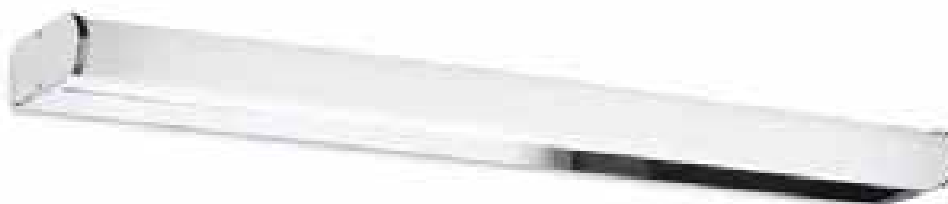

05-2325-21-M1
1 x T5 HO 24W

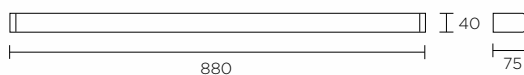

05-2326-21-M1
1 x T5 HO 39W



05-4376-21-M1
1 x T5 8W

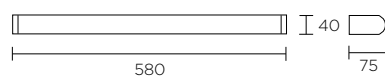

05-4375-21-M1
1 x T5 14W

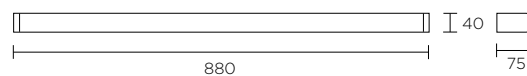

05-4374-21-M1
1 x T5 21W

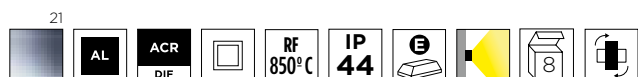



TOILET Q

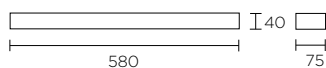

05-2327-21-M1
1 x T5 HO 24W

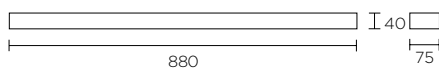

05-2328-21-M1
1 x T5 HO 39W

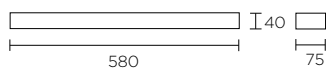

05-4377-21-M1
1 x T5 14W

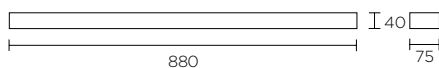

05-4378-21-M1
1 x T5 21W

05-1507-21-M1
LED 10W 910 lm^(N)

100-240V 50-60Hz

LED

W WHITE

05-1508-21-M1
LED 16W 1405 lm^(N)

LED

W WHITE

21





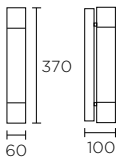

DECORATIVE | BATH

DRESDE



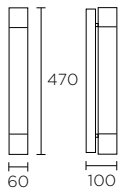

05-4385-21-M1
 1 x 2G11 18W

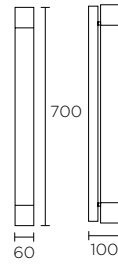
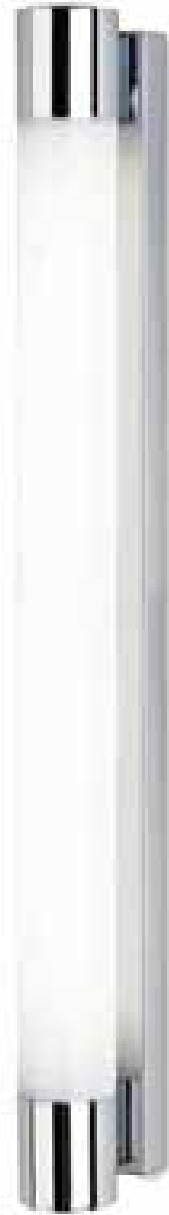

05-4386-21-M1
 1 x 2G11 24W



05-4387-21-M1
 1 x 2G11 40W

21





DECORATIVE | BATH

DRESDE EVO

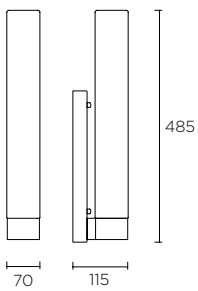



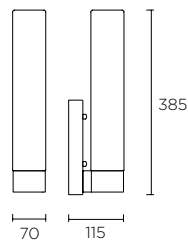

05-0028-21-F9
 1 x 2G11 36W



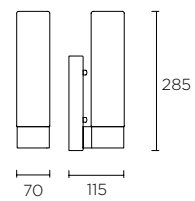

05-0027-21-F9
 1 x 2G11 24W





05-0026-21-F9
 1 x 2G11 18W





DRESDE ON

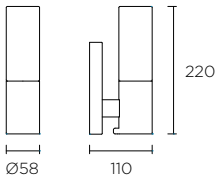

05-1411-21-F9

1 X E-14 MAX. 40W | Ø= 50 MM L= 110 MM
HALOGEN - FLOURESCENT -LED

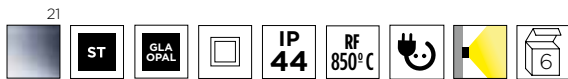

BATH

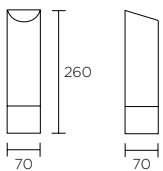



05-4379-81-F9

1 X E-27 PL ELEC. MAX. 20W | Ø= 60 MM L= 170 MM
HALOGEN - FLUORESCENT - LED



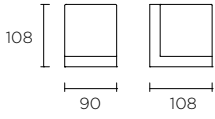

ORION





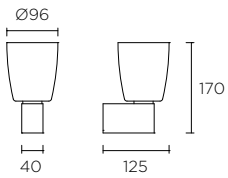

05-1389-21-F9
 1 X G9 MAX. 40W



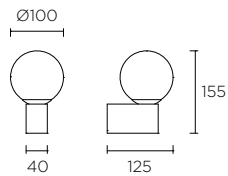

05-1383-21-F9
 1 X E-14 MAX 40W MAX. | L=50 MM Ø= 110 MM
 HALOGEN - FLUORESCENT - LED





05-1410-21-F9
 LED EDISON 4W
 300 lm^(N)

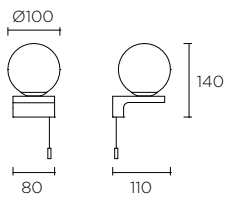

 WHITE





05-1380-21-F9
 1X G9 40W



 21







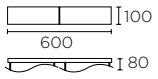
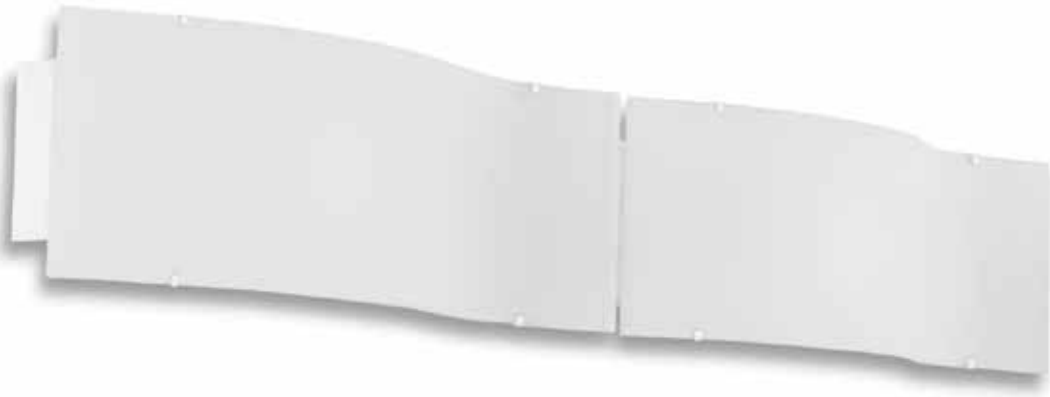

DECORATIVE | BATH

ONDA

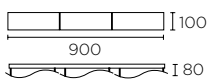
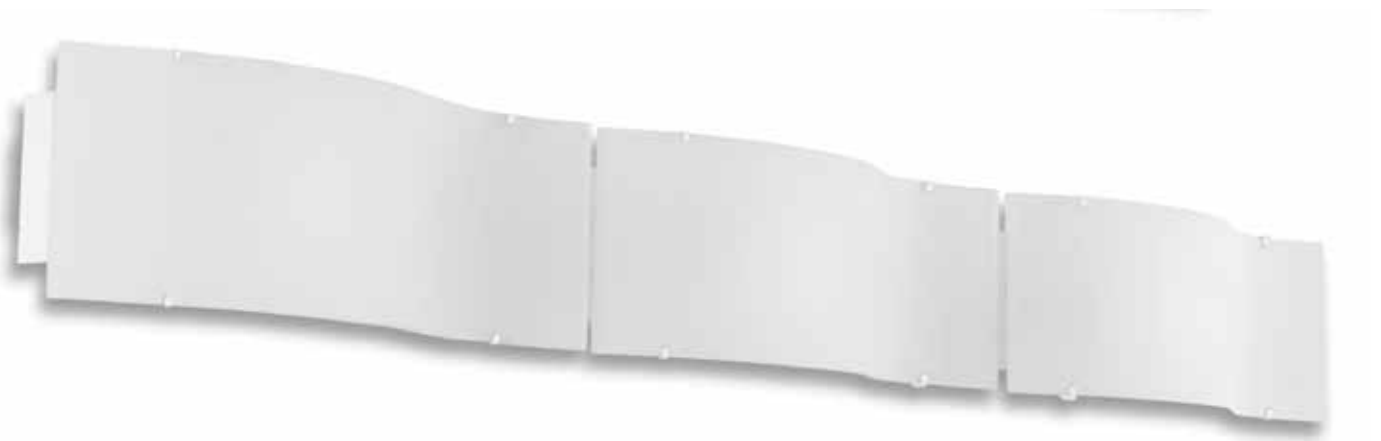

486-BL

2 X G9 MAX. 75W OSRAM INCLUDED



487-BL

3 X G9 MAX. 75W OSRAM INCLUDED





DECORATIVE | BATH

LORIENT

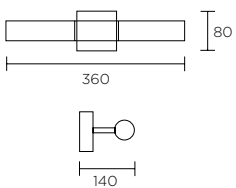
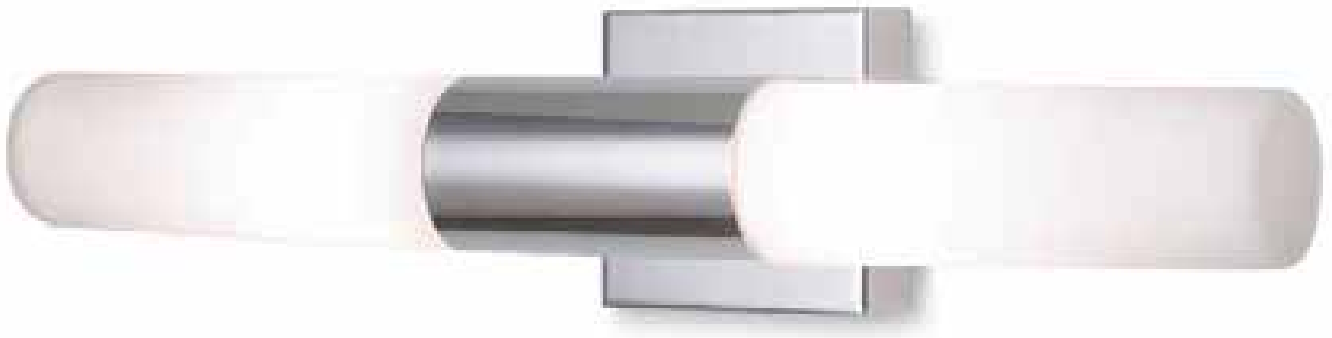

05-4373-21-F9

2 X G9 MAX. 40W OSRAM INCLUDED

21

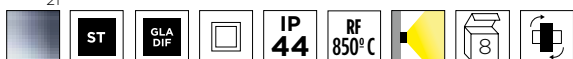



DECORATIVE | BATH

FLOW

NEW

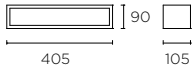

05-3213-21-B4

2 X E-27 MAX. 46W | L= 130 MM Ø= 85 MM
HALOGEN - FLUORESCENT - LED

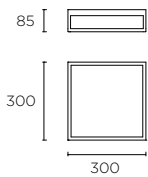

15-3213-21-B4

3 X E-27 MAX. 46W | L= 110 MM Ø= 60 MM
HALOGEN - FLUORESCENT - LED

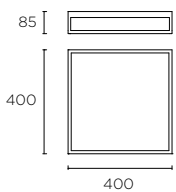

15-3214-21-B4

3 X E-27 MAX. 46W | L= 150 MM Ø= 60 MM
HALOGEN - FLUORESCENT - LED





DEC

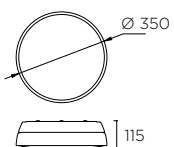

15-4370-21-F9

2 X E-27 PL ELEC. MAX. 40W | Ø= 60 MM L= 160 MM
HALOGEN - FLUORESCENT - LED





PARMA



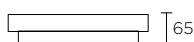
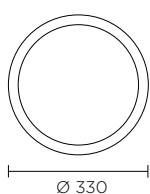



DECORATIVE | BATH

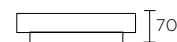
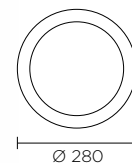

15-1733-81-f9
 2 X G24D3 26W







366-NS
 1 X R7S L = 78 MAX. 100W
OSRAM INCLUDED

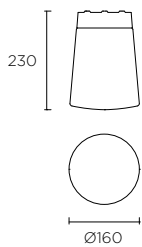

BOB

NEW



15-2514-21-F9

1 X E-27 MAX. 60W | L= 170 MM Ø= 130 MM
HALOGEN - FLUORESCENT - LED

21





EIS

71-4396-00-00
(Kit GU10)

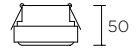

90-1689-21-37

1 X GU5.3 MAX. 50W
HALOGEN - LED

RECOMMENDED ACT-FLL-021

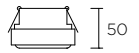

90-1690-21-37

1 X GU5.3 MAX. 50W
HALOGEN - LED

RECOMMENDED ACT-FLL-021

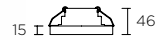
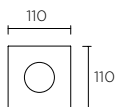

90-1792-21-37

1 X GU5.3 MAX. 50W
HALOGEN - LED

RECOMMENDED ACT-FLL-021



90-1789-21-37

1 X GU5.3 MAX. 50W
HALOGEN - LED

RECOMMENDED ACT-FLL-021

21



P. 873



DECORATIVE | BATH

FÓRMULA

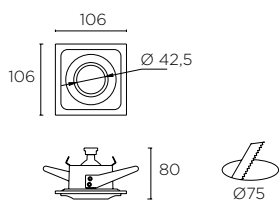

□
90-4349-14-B9
1 X GU-5.3 MAX. 50W 12V
HALOGEN - LED

71-4396-00-00
(Kit GU10)

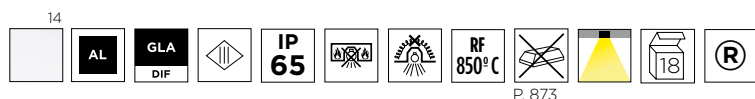

P. 873



DECORATIVE | BATH

SPLIT

71-4396-00-00
(Kit GU10)

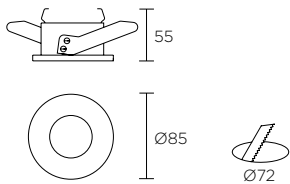

320-BL

1 X GU-5.3 MAX. 50W 12V
HALOGEN - LED

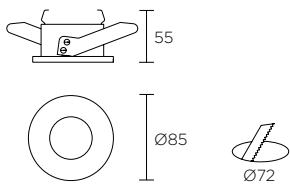

320-CR

1 X GU-5.3 MAX. 50W 12V
HALOGEN - LED

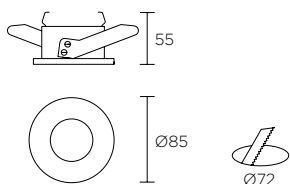

320-NS

1 X GU-5.3 MAX. 50W 12V
HALOGEN - LED



P. 873



DECORATIVE | BATH

GLANZ

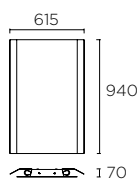

75-4371-K3-M1
2 x T5 39W





DECORATIVE | BATH

REFLEX

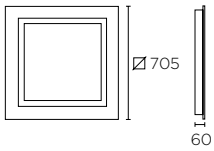

427-ES
4 X 2G11 40W

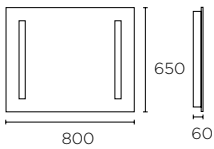

426-ES
2 X 2G11 55W

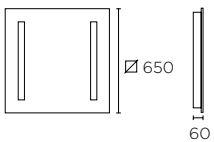

425-ES
2 X 2G11 55W

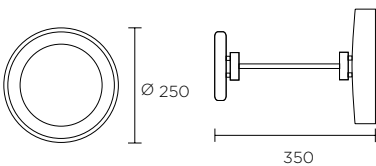

476-CR
1 x T5 22W
4000K NEUTRAL WHITE INCLUDED



VANITY 1



DECORATIVE | BATH

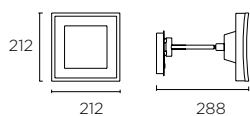
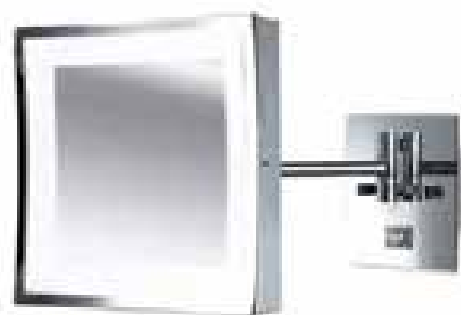

75-4366-21-K3

1 X GX 53 MAX. 9W

RECOMMENDED MEGAMAN 9W



CHOOSE YOUR FAN

CÓMO ELEGIR SU VENTILADOR | HOW TO CHOOSE YOUR FAN | COMMENT CHOISIR VOTRE VENTILATEUR | AUSWAHL DES GEEIGNETEN VENTILATORS | COME SCEGLIERE IL SUO/LA SUA VENTILATORE DA SOFFITTO | COMO ESCOLHER O SEU VENTILADOR | КАК ВЫБРАТЬ ВЕНТИЛЯТОР | JAK WYBRAĆ WENTYLATOR

1

LUZ | LIGHT | LUMIÈRE | LICHT | LUCE | LUZ | CBET | ŚWIATŁO



CON LUZ
WITH LIGHT
AVEC LUMIÈRE
MIT LICHT
CON LUCE
COM LUZ
CO CBETOM
ZE ŚWIATŁEM

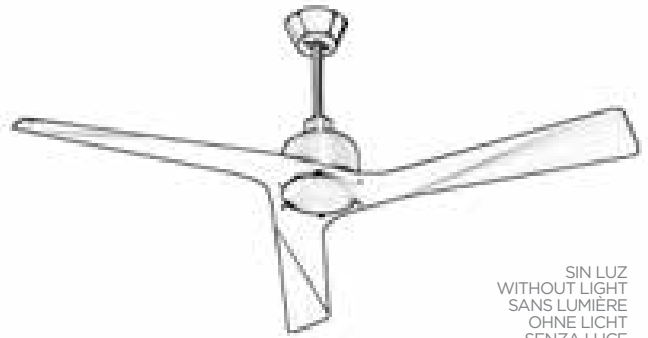

SIN LUZ
WITHOUT LIGHT
SANS LUMIÈRE
OHNE LICHT
SENZA LUCE
SEM LUZ
БЕЗ CBETA
BEZ ŚWIATŁA



2

MEDIDA | SIZE | DIMENSION | GRÖSSE | DIMENSIONE | DIMENSÃO | РАЗМЕРЫ | ROZMIAR



< 15 M²

S



< 1000 mm



15 M² - 20 M²

M



> 1000 mm
< 1320 mm



> 20 M²

L



> 1320 mm

3

DISEÑO | DESIGN | DESIGN | DESIGN | DESENHO | DESIGN | ДИЗАЙН | WZÓR

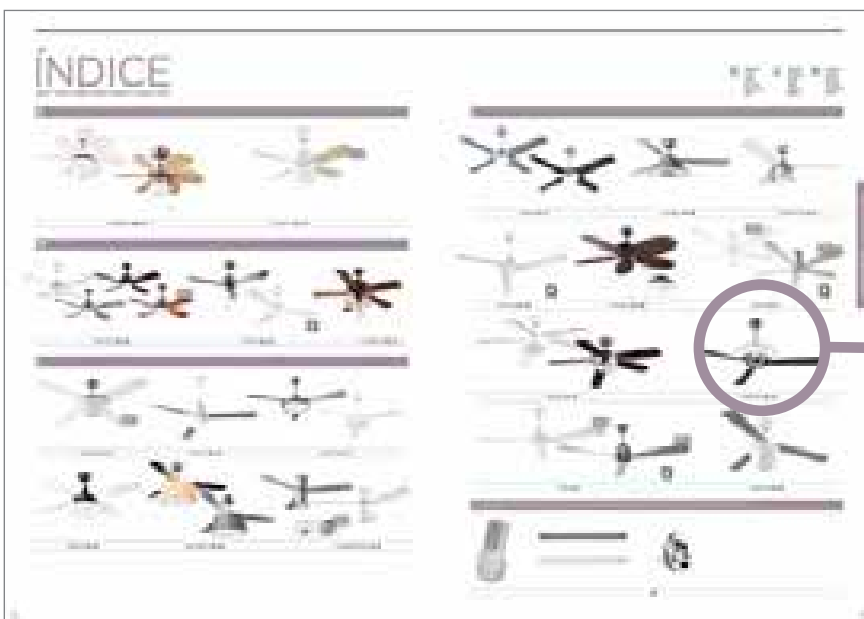

- ELIJA ENTRE LAS DIFERENTES OPCIONES
- CHOOSE AMONGST THE DIFFERENT DESIGNS
- CHOISISSEZ PARMIL LES DIFFÉRENTES OPTIONS
- WÄHLEN SIE ZWISCHEN DEN VERSCHIEDENEN OPTIONEN
- SCEGLIERE TRA LE DIVERSE OPZIONI
- ESCOLHA ENTRE AS DIFERENTES OPÇÕES
- ВЫБЕРИТЕ ОДНУ ИЗ ОПЦИЙ
- PROSZE WYBRAĆ POMIĘDZY RÓŻNYMI OPCJAMI

VENTAJAS | ADVANTAGES | AVANTAGES | VORTEILE | VANTAGGI VANTAGENS | ПРЕИМУЩЕСТВА | ZALETY

FUNCIÓN INVERSA | REVERSE FUNCTION | FONCTION INVERSE | INVERSE-FUNKTION | FUNZIONE INVERSA |
FUNÇÃO INVERSA | ОБРАТНАЯ ФУНКЦИЯ | ODWROTNA FUNKCJA

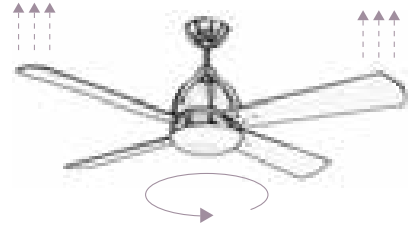
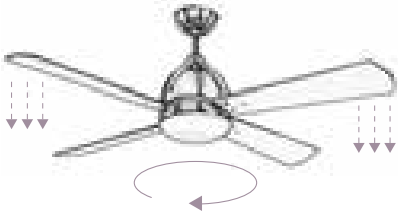

Úsalo todo el año
Use it all year round
Utilisez-le toute l'année
Sommer - und winterbetrieb
Usalo tutto l'anno
Utilize-o todo o ano
Пользуйтесь им круглый год
Proszę używać go przez cały rok



DECORATIVE | CEILING FANS

AHORRA Y PROTEGE | SAVE AND PROTECT | ÉCONOMISE ET PROTÈGE | SPAREN UND SCHÜTZEN | RISPARMIA E PROTEGGE
ECONOMIZA E PROTEGE | ЭКОНОМИТ И ЗАЩИЩАЕТ | OSZCZĘDZA I ZABEZPIECZA



SILENCIOSO | SILENT | SILENCIEUX | GERÄUSCHARM | SILENZIOSO
SILENCIOSO | БЕСШУМНЫЙ | CICHY

GARANTÍA | GUARANTEE | GARANTIE | GARANTIE
GARANZIA | GARANTIA | ГАРАНТИЯ | GWARANCJA



CONSEJOS | ADVICES | CONSEILS | TIPPS
CONSIGLI | CONSELHOS | COBETЫ | PORADY

ALTURA | HEIGHT | HAUTEUR | HÖHE | ALTEZZA | ALTURA
ВЫСОТА | WYSOKOŚĆ

INSTALACIÓN | INSTALLATION | INSTALLATION | INSTALLATION
INSTALLAZIONE | INSTALAÇÃO | УСТАНОВКА | INSTALACJA

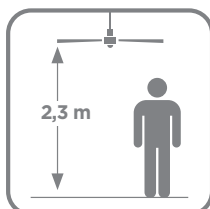
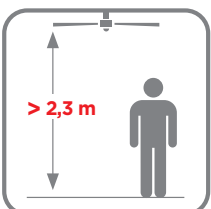
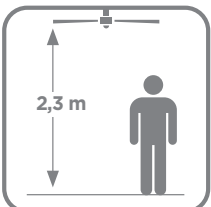

P. 881

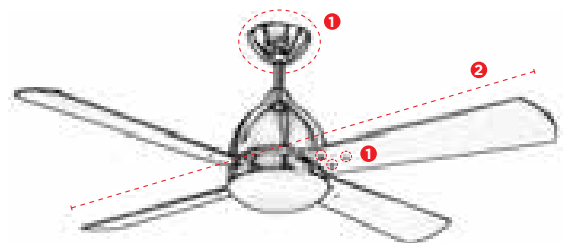

1 Fije correctamente el soporte y las palas
Fix the support and the blades correctly
2 Utilice los contrapesos en caso de balanceo
If it is unstable, please use the counterweights

3 Finalmente, tenga en cuenta que es necesario un período de 24h de asentamiento
Finally, please be aware that it is necessary to allow a 24-hour settling period

TIGA

BY ESTUDI RIBAUDÍ

NEW



CF



30-3249-CF-M1



HALO DE LUZ
HALO LIGHT
FAISCEAU LUMINEUX
LICHTBÜNDEL
FASCIO DI LUCE
FEIXE DE LUZ
ОРЕОЛ СΒΕΤΑ
ODBLASK ŚWIATŁA

LED 91 X 0,2W = 18W | 1800 Lm^(ND) | 3000K

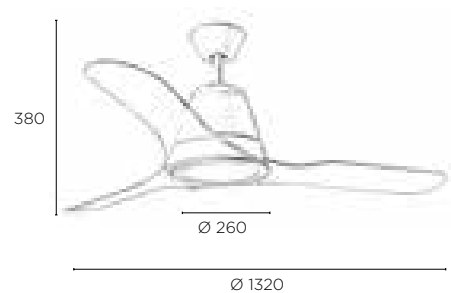
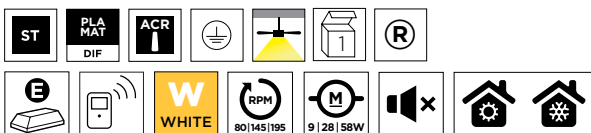



DECORATIVE | CEILING FANS

VINTAGE

BY MANEL LLUSCÀ

NEW



Z6

30-3248-CG-E9

REVERSIBLE



16

30-3248-16-E9

REVERSIBLE



2 X E-27 MAX. 60W | L=140 MM Ø=60 MM
HALOGEN - FLUORESCENT - LED

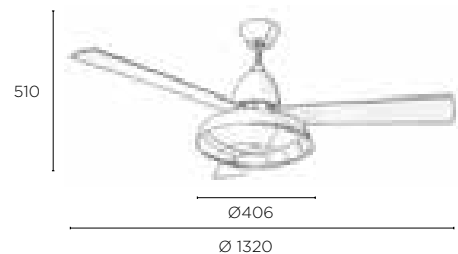
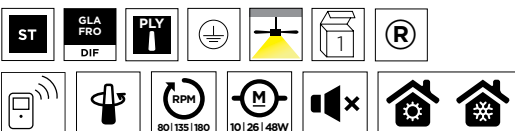



CEOS

BY BENEDITO DESIGN

NEW



CF



30-3250-CF-M1



LED 70 X 0,2W = 14W | 1400Lm^(ND) | 3000K

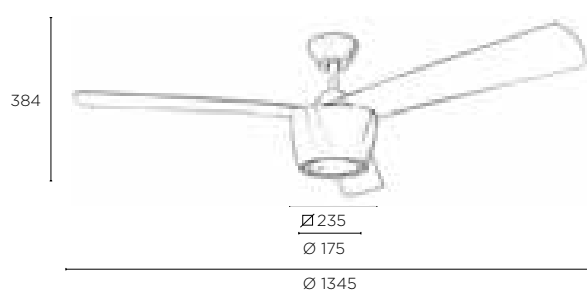
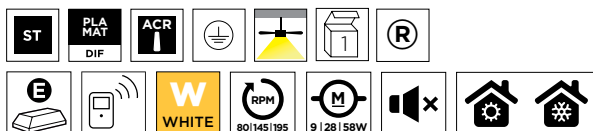



DECORATIVE | CEILING FANS

TUPAI

BY BENEDITO DESIGN



REVERSIBLE 



CF



30-1961-CF-CF



REVERSIBLE 

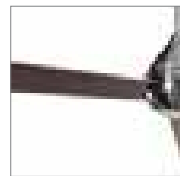

81



30-1961-81-81

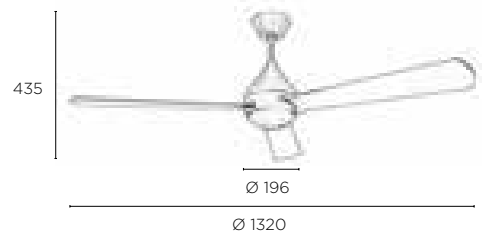
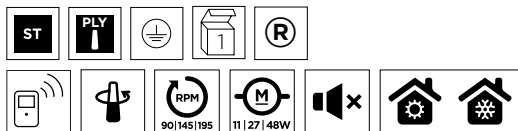



DECORATIVE | CEILING FANS

RODAS

BY ESTUDI RIBAUDÍ



N3

30-1964-N3-N3

REVERSIBLE



CF

30-1964-CF-CF

REVERSIBLE



Discos de color incluidos
 Colour disks included
 Disques de couleur fournis
 Farbfilter mitgeliefert
 Dischi colorati inclusi
 Discos de cor incluidos
 Цветные диски включены
 Zawarte kolorowe dyski

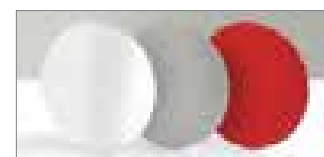

Opcional
 Optional
 En option
 Zubehör
 Opzionale
 Opcional
 Дополнительно
 Do wyboru

71-1964-N3-N3 | 71-1964-CF-CF

N3 CF

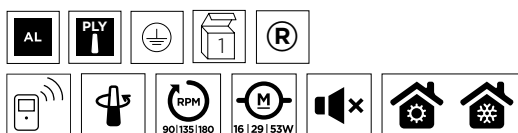

290

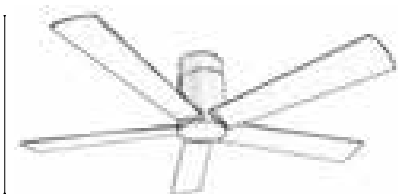

Ø 170

Ø 1320



DECORATIVE | CEILING FANS

AUKENA

BY ESTUDI RIBAUDÍ



81



30-1965-81-E9

REVERSIBLE



2 X E-27 MAX. 60W | L=140 MM Ø=60 MM
HALOGEN - FLUORESCENT - LED

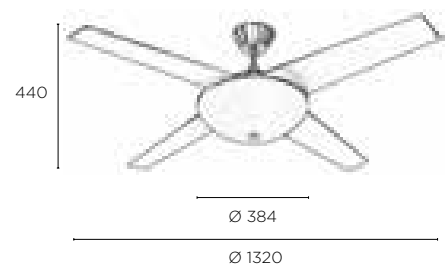
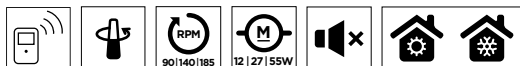
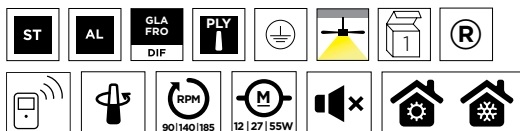



DECORATIVE | CEILING FANS

FORMENTERA

BY ESTUDI RIBAUDÍ



CF

30-4393-CF-M1

REVERSIBLE



N3

N3

127V
60Hz

30-4393-N3-M1 | 30-1966-N3-M1

REVERSIBLE



Kit de luz opcional
Optional lighting kit
Kit d'éclairage en option
Licht-Kit als Zubehör
Kit di luce opzionale
Kit de iluminação opcional
Дополнительный световой набор
Zestaw światła do wyboru

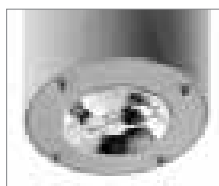

71-4393-CF-CF | 71-4393-N3-N3

CF

N3



1 X AR-111 GU10 | L= Max. 104 MM Ø=111 MM | LED

1 X E27 MAX. 23W | L=140 MM Ø=56 MM
FLUORESCENT - LED

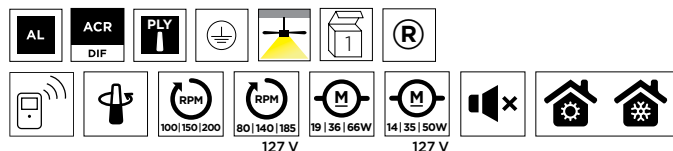

390

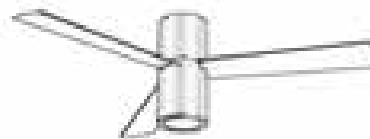

Ø 170

Ø 1320



DECORATIVE | CEILING FANS

HAWAI



81

30-2854-81-F9

REVERSIBLE 



1 X R7S MAX. 100W | L=74,9 MM | HALOGEN INCLUDED

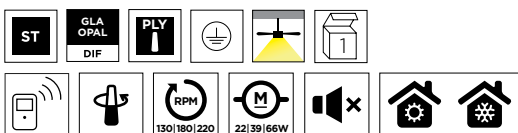

MIN 360/
MAX 515

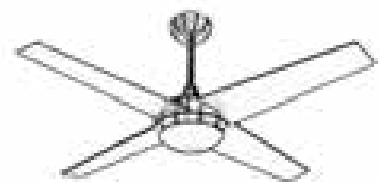

Ø 250

Ø 1320



DECORATIVE | CEILING FANS

SAMAL



14

30-0068-14-F9

REVERSIBLE



81

30-0068-81-F9

REVERSIBLE



2 X E-27 MAX. 40W | L=115 MM Ø=56 MM
HALOGEN - FLUORESCENT - LED

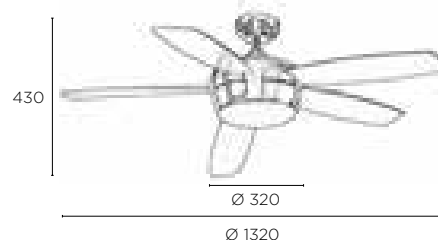
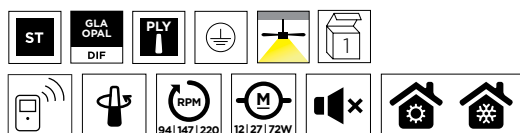



DECORATIVE | CEILING FANS

BAHIA

BY BENEDITO DESIGN



CF

30-4355-CF-M1

REVERSIBLE



81

30-4355-81-M1

REVERSIBLE



1 X 2GX13 55W | FLUORESCENT

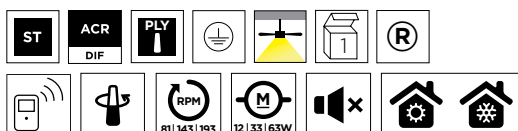

MIN 336/
MAX 491



Ø 420

Ø 1320



DECORATIVE | CEILING FANS

TWENTY

BY ESTUDI RIBAUDÍ



14 14 127V 60Hz
30-0013-14-M1 | 30-2009-14-M1

REVERSIBLE



2 X E-27 MAX. 23W | L=176 MM Ø=56 MM
 FLUORESCENT - LED

		127 V	127 V		127 V			

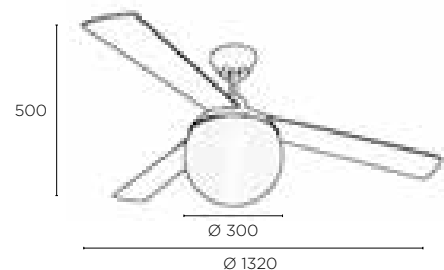



DECORATIVE | CEILING FANS

BAGUR

BY ESTUDI RIBAUDÍ



















CF CF 127V 60Hz
30-4394-CF-F9 | 30-1975-CF-F9

REVERSIBLE 



2 X E-27 MAX. 40W | L=140 MM Ø=56 MM
 HALOGEN - FLUORESCENT - LED

								
								
		127 V	127 V	127 V	127 V			

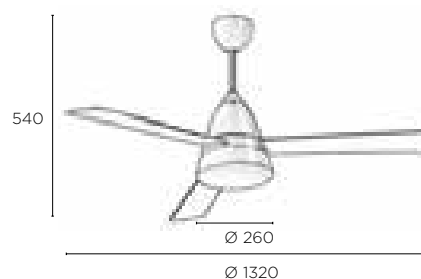



DECORATIVE | CEILING FANS

BANUS

BY FRANCESC VILARÓ



30-4395-J7-M1 | 30-1976-J7-M1

REVERSIBLE



2 X E27 MAX. 23W | L=176 MM Ø=56 MM
FLUORESCENT - LED

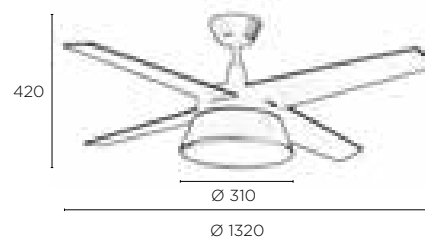
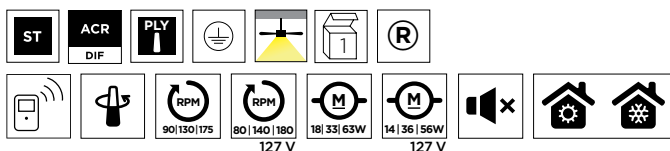



DECORATIVE | CEILING FANS

TORONTO

BY BENEDITO DESIGN



30-4354-81-M1

REVERSIBLE 



1 X 2GX13 55W | FLUORESCENT

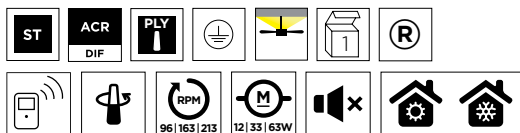

MIN 325/
MAX 480

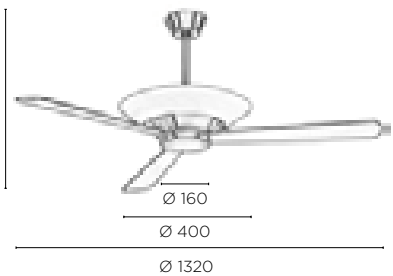



DECORATIVE | CEILING FANS

BELMONT

BY YAGO SARRI



















81 81 127V 60Hz
30-4357-81-82 | 30-1971-81-82

+
 20 AJ
PAN-146-20 | PAN-146-AJ

REVERSIBLE 



3 X E-27 MAX. 60W | L=176 MM Ø=56 MM
 HALOGEN - FLUORESCENT - LED

							
							
		80 140 190	85 145 195	19 35 50W	14 36 56W		
		127 V		127 V			

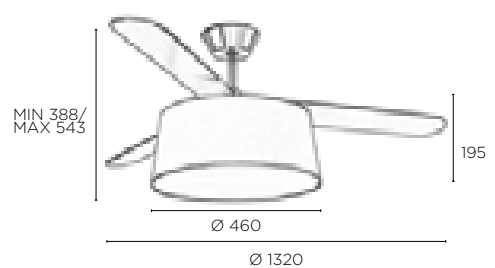



PHUKET



J7

30-4398-J7-J7

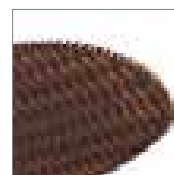

Simil ratán
 Similar to rattan
 Imitation rotin
 Rattan-Nachahmung
 Simil rattan
 Semelhante a rotim
 Под ратан
 Podobny do ratanu

Kit de luz opcional
 Optional lighting kit
 Kit d'éclairage en option
 Licht-Kit als Zubehör
 Kit di luce opzionale
 Kit de iluminação opcional
 Дополнительный световой набор
 Zestaw świateł do wyboru

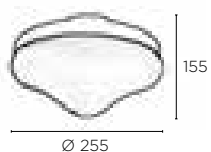

71-4398-J7-F9

2 X E-27 MAX. 60W | L=140 MM Ø=60 MM
 HALOGEN - FLUORESCENT - LED

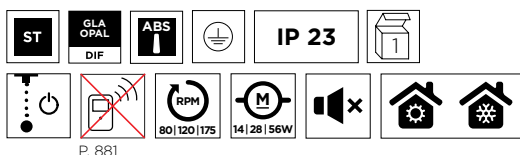

P. 881

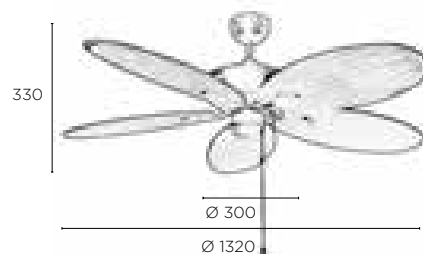



MOGAN

BY YAGO SARRI



CF



30-4356-CF-CF

REVERSIBLE

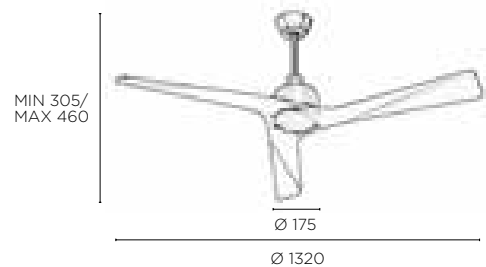
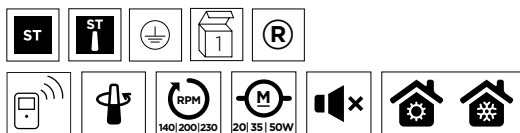
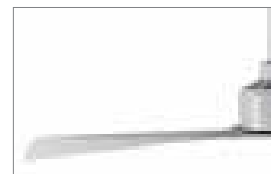



DECORATIVE | CEILING FANS

BORNEO



14
30-4399-14-F9

REVERSIBLE 



81
30-4399-81-F9

REVERSIBLE 



E4
30-4399-E4-F9

REVERSIBLE 

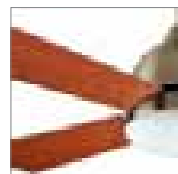

2 X E-27 MAX. 60W | L=140 MM Ø=45 MM
HALOGEN - FLUORESCENT - LED

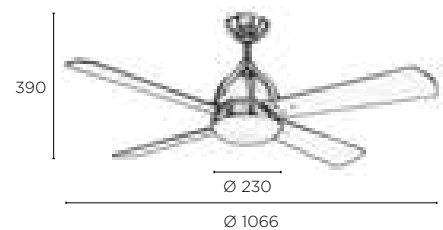
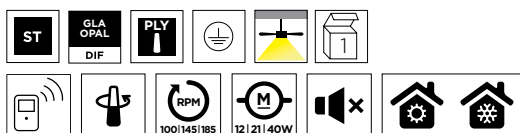



DECORATIVE | CEILING FANS

REVERSIBLE



J7



30-4399-J7-F9

DOMINICA



J7



30-4405-J7-E7

REVERSIBLE



3 X E-27 MAX. 60W | L=140 MM Ø=56 MM
HALOGEN - FLUORESCENT - LED

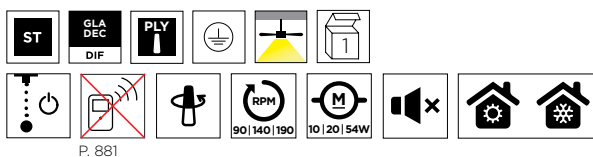

P. 881

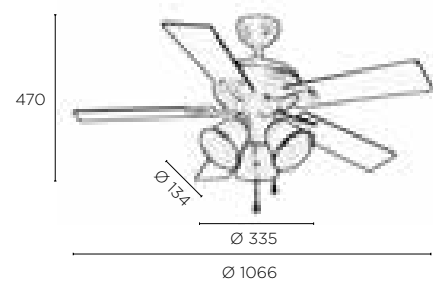



DECORATIVE | CEILING FANS

BOUVET



CF



30-1854-CF-F9

REVERSIBLE



2 X E-27 MAX. 20W | L=115 MM Ø=56 MM
FLUORESCENT - LED

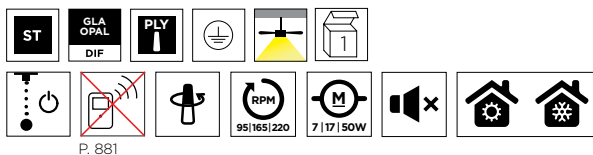

P. 881

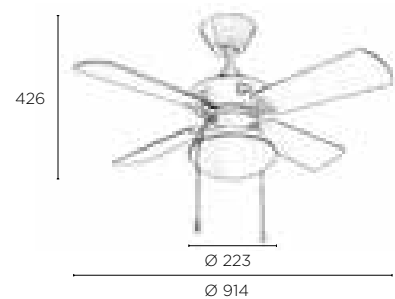



DECORATIVE | CEILING FANS

JUNCAL

BY STIMULO



N3 N3
127V
60Hz
30-4392-N3-M1 | 30-1978-N3-M1

REVERSIBLE 



1 X 2GX13 55W | FLUORESCENT

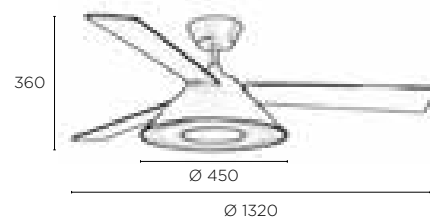
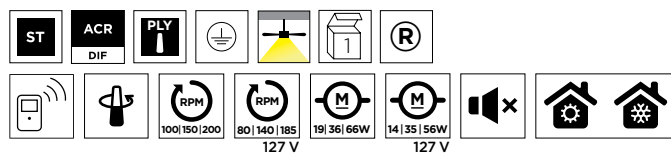

MAURITIUS

BY BENEDITO DESIGN



N3

30-0009-N3-B8

REVERSIBLE



2 X E-27 MAX. 60W | L=140 MM Ø=56 MM
HALOGEN - FLUORESCENT - LED

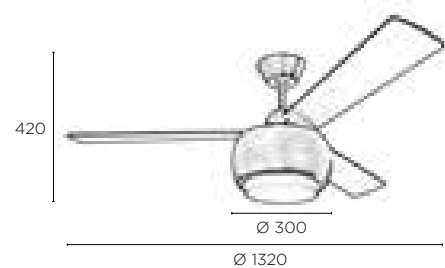
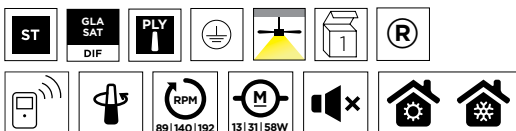

DECORATIVE | CEILING FANS

CORON



14

30-0067-14-14



81

30-0067-81-81

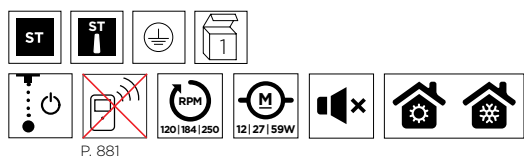

P. 881

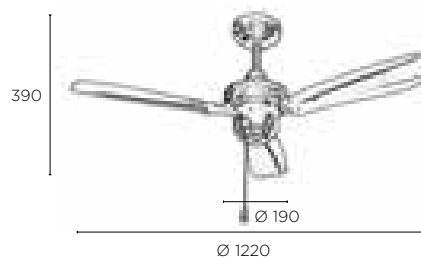

BORACAY



CF
30-4404-CF-F9

REVERSIBLE 

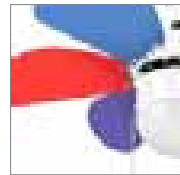















81
30-4404-81-F9

REVERSIBLE 



1 X G9 MAX. 60W | L=75 MM Ø=37 MM
 HALOGEN - FLUORESCENT

					
					
P. 881		100 145 200		9 20 48W	
					

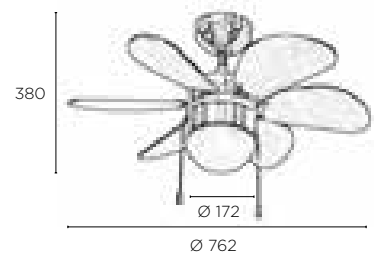



OUTDOOR

 494-523
**WALL WASHERS
 & SPOTLIGHTS**
 BAÑADORES DE PARED
 Y PROYECTORES
 LÈCHE-MURS ET
 PROJECTEURS ET SPOTS
 WALL WASHER
 UND STRAHLER
 WALL WASHERS E PROIETTORI
 WALL WASHERS E PROJECTORES
 СВЕТОВАЯ ЗАЛИВКА СТЕН
 И ПРОЖЕКТОРЫ
 REFLEKTORY OPRAWY TYPU WALL
 WASHERS

 524-593
WALL FIXTURES
 APLIQUES
 APPLIQUES
 WANDLEUCHTEN
 APPLIQUE
 APLIQUES
 НАСТЕННЫЕ
 KINKIETY

 594-613
CEILING
 TECHO
 PLAFONNIERS
 DECKENLEUCHTEN
 PLAFONIERE
 TECTO
 ПОТОЛОЧНЫЕ
 SUFITOWE

 614-655
RECESSED
 EMPOTRADOS
 ENCASTRES
 EINBAULEUCHTEN
 INCASSI
 ENCASTRÁVEIS
 ВСТРАИВАЕМЫЕ
 WPUSZCZANE

 656-661
SUBMERSIBLE
 SUMERGIBLES
 SUBMERSIBLES
 VERSENKBARE LEUCHTEN
 LUCI SOMMERGIBILI
 SUBMERSIVEIS
 ПОГРУЖАЕМЫЕ В ВОДУ
 ZANURZALNE

 662-673
CHILL-OUT
 CHILLOUT
 CHILLOUT
 CHILLOUT-BELEUCHTUNG
 CHILLOUT
 CHILLOUT
 ДЛЯ ЗОНЫ ОТДЫХА
 CHILLOUT

 674-683
LANTERNS
 SOBREMUIROS
 BORNES
 SOCKELLEUCHTEN
 LANTERNE DA GIARDINO
 SOBREMUIROS
 ПАРКОВЫЕ СТОЛБЫ
 LATARNIE

 684-719
BOLLARDS
 BALIZAS
 BALISES
 POLLERLEUCHTEN
 FARI
 PIMENTEIROS
 НАЗЕМНЫЕ СТОЛБЫ
 SŁUPKI

 720-729
STREET LIGHTS
 FAROLAS
 RÉVERBÈRES
 MASTLEUCHTEN
 LAMPIONI
 POSTES DE ILUMINAÇÃO
 ФОНАРИ
 LAMPY ULICZNE

 730-807
**URBAN
 LIGHTING**
 ILUMINACIÓN URBANA
 ÉCLAIRAGE URBAIN
 STRASSENLEUCHTEN
 ILLUMINAZIONE URBANA
 ILUMINAÇÃO PÚBLICA
 ГОРОДСКОЕ ОСВЕЩЕНИЕ
 OŚWIETLENIE MIEJSKIE





CONVERT NEW

05-9749-54-37

6 LED CREE 110-230V 13W 1122lm^(N)
Neutral white 4000K



MEAN WELL

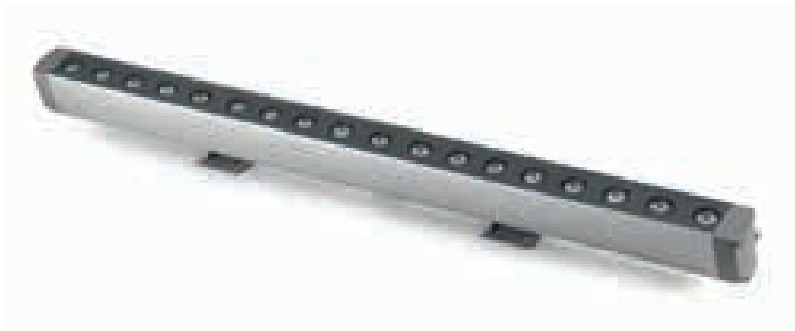
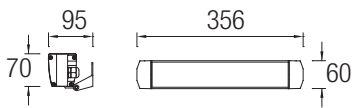

CONVERT NEW

05-9750-54-37

18 LED CREE 110-230V 40W 3366lm^(N)
Neutral white 4000K



MEAN WELL

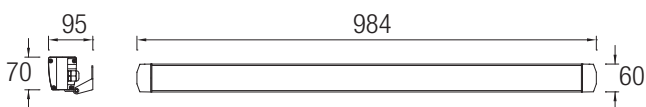



ARENAS SHOPPING CENTER. BARCELONA, SPAIN.

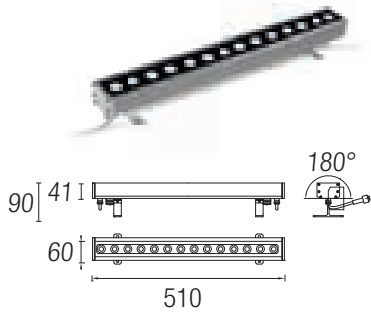

TRON NEW

05-1546-54-H6

14 LED CREE 24 VDC 14W 2380 lm^(N)
Neutral white 4000K

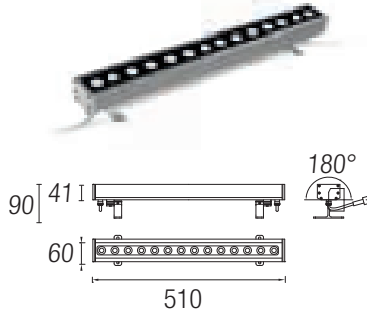
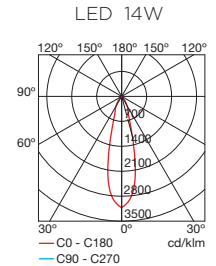
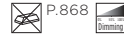

TRON NEW

05-1547-54-H6

14 LED CREE 24 VDC 14W 2023 lm^(N)
Warm white 3000K

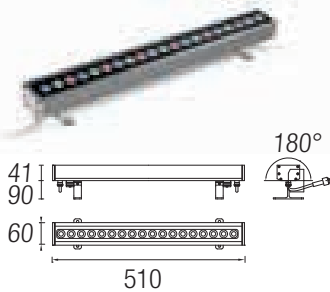
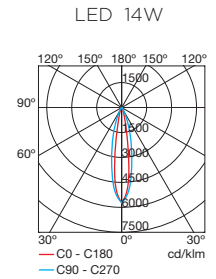
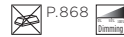

TRON NEW

05-1544-54-H6

18 LED CREE 24 VDC 30W 1465 lm^(N) **RGB**

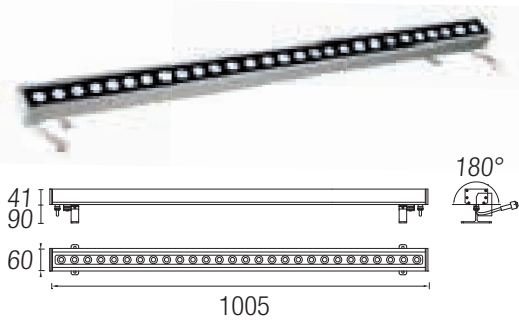
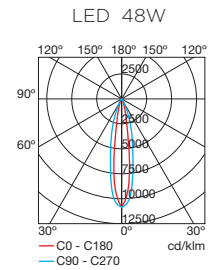
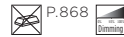

TRON NEW

05-1549-54-H6

28 LED CREE 24 VDC 48W 4760 lm^(N)
Neutral white 4000K

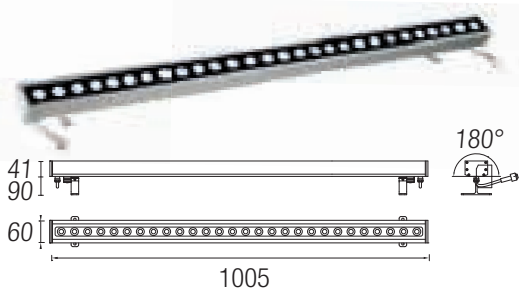
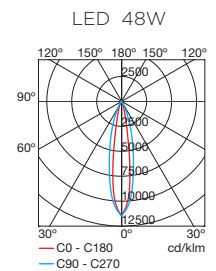

TRON NEW

05-1552-54-H6

28 LED CREE 24 VDC 48W 4046 lm^(N)
Warm white 3000K

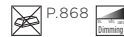

TRON NEW

05-1548-54-H6

36 LED CREE 24 VDC 60W 3768 lm^(N) **RGB**

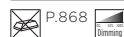



FRONDA GARDEN CENTER. MADRID, SPAIN.

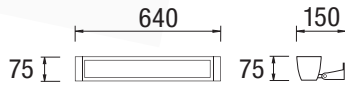

HECATE

05-9264-Z5-37

T5 24W Fluorescent 230V



BAG



T5 24W

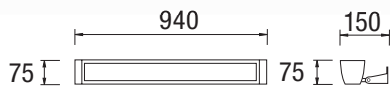
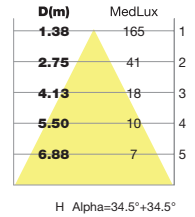
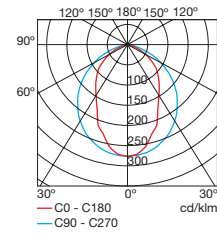

HECATE

05-9265-Z5-37

T5 39W Fluorescent 230V



BAG



T5 39W

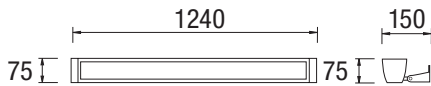
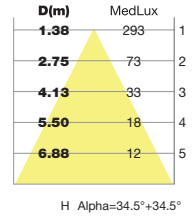
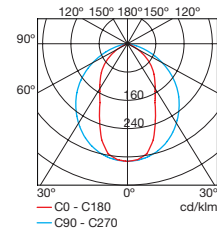

HECATE

05-9266-Z5-37

T5 54W Fluorescent 230V



BAG



T5 54W

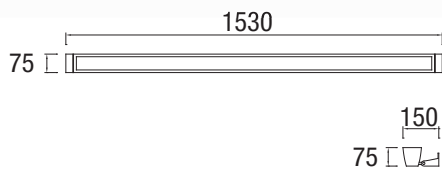
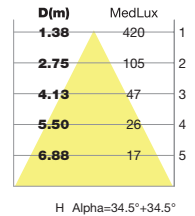
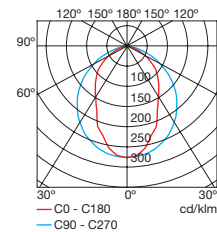

HECATE

05-9439-Z5-37

T5 80W Fluorescent 230V



BAG



T5 80W

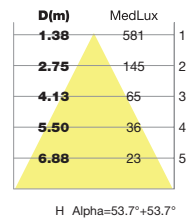
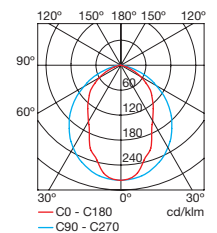

Accesorios para fijación en pared o techo incluidos.
 Accessoires for wall or ceiling fitting included.
 Accessoires de fixation murale ou au plafond inclus.
 Zubehöre zur Befestigung an Wänden und Decken inklusive.
 Accessori per fissaggio nella parete o tetto inclusi.
 Acessórios para a fixação em parede ou tecto incluídos.
 Настенный или потолочный крепеж в комплекте.
 Akcesoria do montażu na ścianie/suficie w komplecie



OUTDOOR | WALL WASHERS



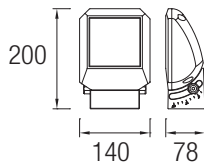

POMPEYA NEW

05-9751-34-37 ■

LED SEOUL 220-240V 16W 1200lm^(nd)
Neutral white 4000K

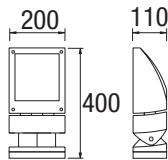
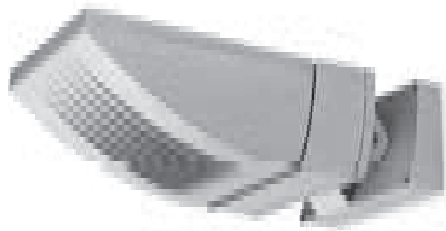

POMPEYA

05-9537-34-37 ■ 35W

05-9538-34-37 ■ 70W

05-9539-34-37 ■ 150W

G12 HID 230V

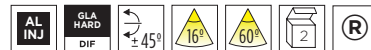

Reflector B Reflector A

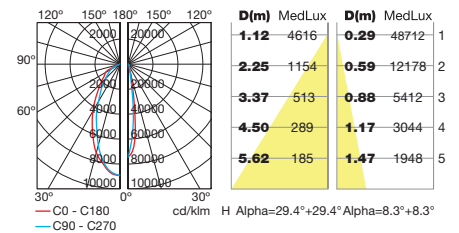

2 reflectores incluidos.
2 reflectors included.
2 réflecteurs inclus.
2 Reflektore inklusive.
2 riflettori inclusi.
2 reflectores incluidos
Прилагаются 2 отражателя.
2 odbłyśniki w komplecie

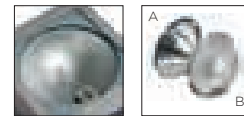

POMPEYA

05-9254-34-37 ■

2 x GX24q-3 26W Fluorescent 230V

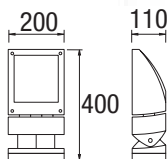
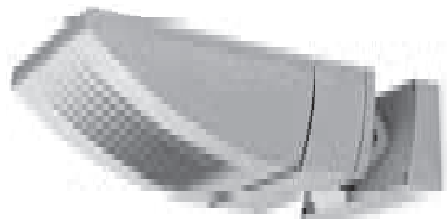
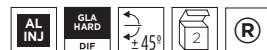

2 x GX24q-3 26W

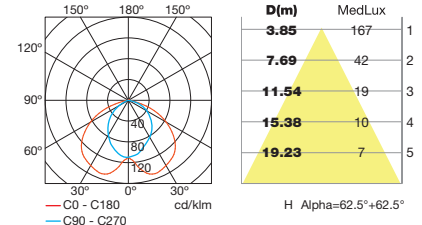

POMPEYA

05-9251-34-37 ■

R7s L=118 max. 300W Halogen

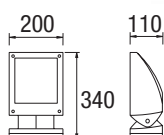
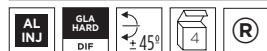

R7s 300W

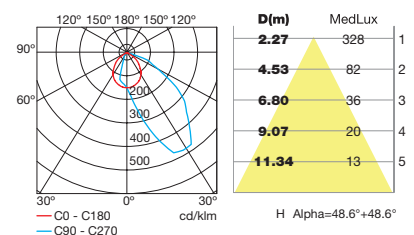



METROPOL PARASOL SPACE. SEVILLA, SPAIN.

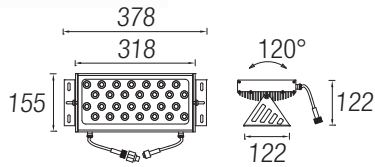

RAY **NEW**

05-2494-54-H6

28 LED CREE 24 VDC 48W 4760 lm^(N)
Neutral white 5500K

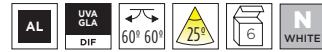
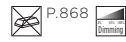

LED 48W

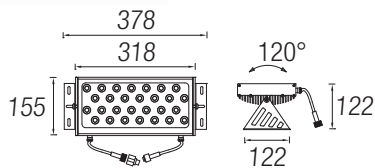
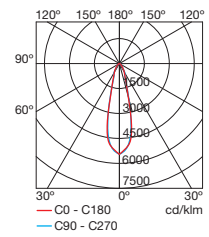

RAY **NEW**

05-2499-54-H6

28 LED CREE 24 VDC 48W 4046 lm^(N)
Warm white 2900K

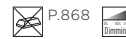

LED 48W

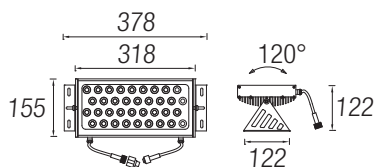
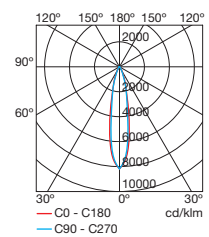

RAY **NEW**

05-2498-54-H6

36 LED CREE 24 VDC 60W 3768 lm^(N)
RGB

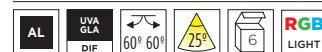



CROWNE PLAZA HOTEL. LIÈGE, BELGIUM

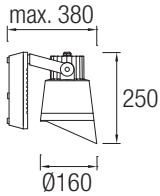

HUBBLE

05-9626-34-37 ■

9 LED PHILIPS 100-240V 19W 1305lm^(N)
Warm white 3000K

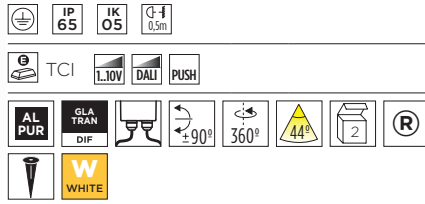

Ópticas de 8° y 28° disponibles bajo pedido. / Lenses of 8° and 28° available upon request / Lentilles de 8° et 28° disponibles sur commande. / 8°- und 28°-Linsen auf Anfrage. / Lenti di 8° e 28° disponibili su richiesta. / Elementos ópticos de 8° e 28° disponíveis sob pedido. / Оптика 8° и 28° может быть установлена по заказу клиента. / Układy optyczne 8° i 28° dostępne na zamówienie.

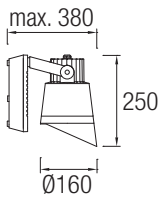
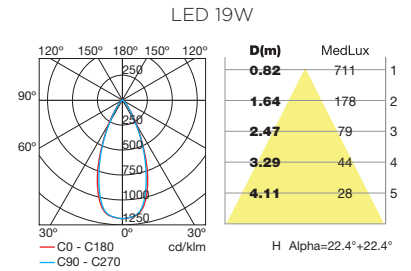

HUBBLE

05-9627-34-37 ■

9 LED PHILIPS 100-240V 19W 1845lm^(N)
Neutral white 4000K

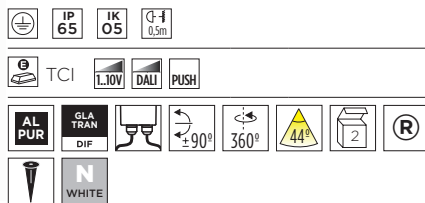

Ópticas de 8° y 28° disponibles bajo pedido. / Lenses of 8° and 28° available upon request / Lentilles de 8° et 28° disponibles sur commande. / 8°- und 28°-Linsen auf Anfrage. / Lenti di 8° e 28° disponibili su richiesta. / Elementos ópticos de 8° e 28° disponíveis sob pedido. / Оптика 8° и 28° может быть установлена по заказу клиента. / Układy optyczne 8° i 28° dostępne na zamówienie.

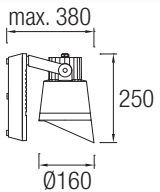

HUBBLE

05-9628-34-37 ■

9 LED PHILIPS 100-240V 19W
RGB

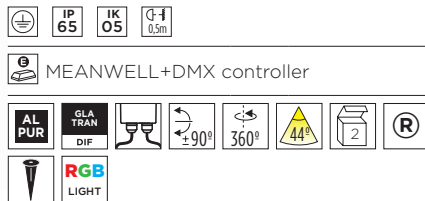

Ópticas de 8° y 28° disponibles bajo pedido. / Lenses of 8° and 28° available upon request / Lentilles de 8° et 28° disponibles sur commande. / 8°- und 28°-Linsen auf Anfrage. / Lenti di 8° e 28° disponibili su richiesta. / Elementos ópticos de 8° e 28° disponíveis sob pedido. / Оптика 8° и 28° может быть установлена по заказу клиента. / Układy optyczne 8° i 28° dostępne na zamówienie.

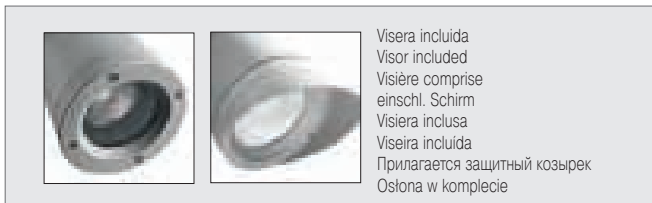

Visera incluida
Visor included
Visière comprise
einschl. Schirm
Visiera inclusa
Visiera incluida
Прилагается защитный козырек
Osłona w komplecie





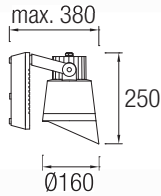

HUBBLE

05-9501-34-37

G8,5 35W HID 230V



OSRAM

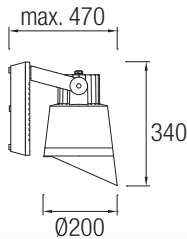
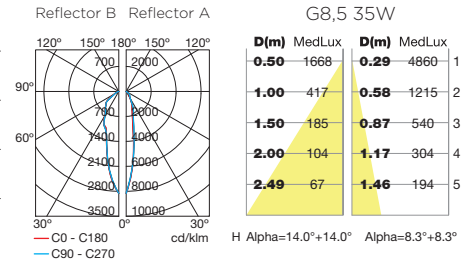
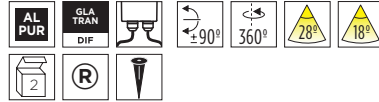

HUBBLE

05-9474-34-37

G12 70W HID 230V



OSRAM

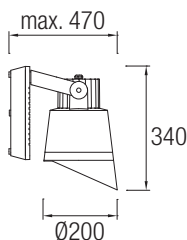
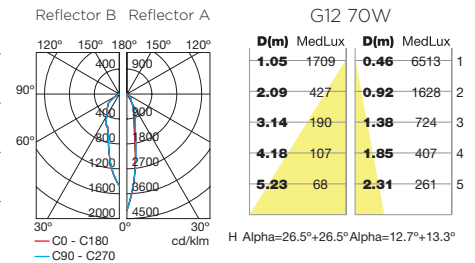
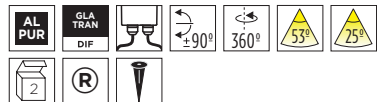

HUBBLE

05-9502-34-37

G12 150W HID 230V



OSRAM

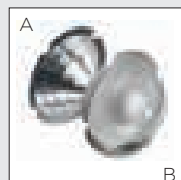
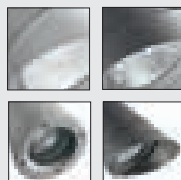
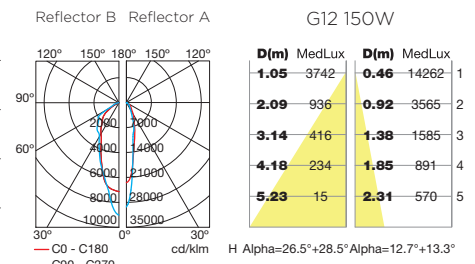

Visera incluida + 2 reflectores incluidos
 Visor included + 2 reflectors included
 Visiere comprise + 2 réflecteurs compris
 einsch. Schirm + 2 Reflektoren
 Visiera inclusa + 2 riflettori inclusi
 Visiera incluida + 2 reflectores incluidos
 Прилагается защитный козырек + 2 отражателя
 Ostona + 2 odbłyśniki w komplecie



PANS & COMPANY SABADELL, BARCELONA, SPAIN.

HUBBLE

05-9647-34-37 ■

05-9647-Z5-37 ■

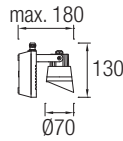

3 LED CREE 100-240V 6,5W 564lm⁽ⁿ⁾
Neutral white 4000K



EAGLE RISE



HUBBLE

05-9416-34-37 ■

05-9416-Z5-37 ■

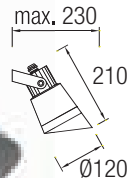

GU-10 max. 50W / max. L= 80mm
Halogen - Fluorescent - LED



OSRAM 50W

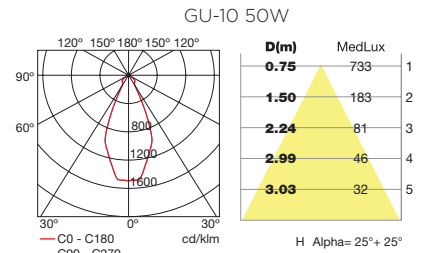

HUBBLE NEW

05-9722-05-37 ■



GU-10/MR-16 max. 50W / max. L= 80mm
Halogen - Fluorescent - LED

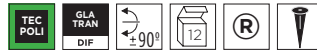

Incluye 2 portalámparas: GU10 y GU5.3 (MR16). / Includes 2 lampholders: GU10 and GU5.3 (MR16). / 2 douilles fournies: GU10 et GU5.3 (MR16). / Einschließlich 2 Fassungen: GU10 und GU5.3 (MR16). / Comprende 2 portalampade: GU10 e GU5.3 (MR16). / Inclui 2 suportes de casquilho: GU10 e GU5.3 (MR16). / В набор включены 2 патрона GU10 и GU5.3 (MR16). / Zawiera 2 oprawki: GU10 i GU5.3 (MR16).

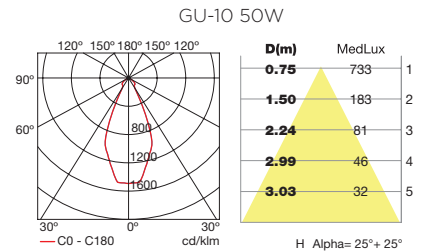

HUBBLE

05-9553-34-37 ■

05-9553-Z5-37 ■

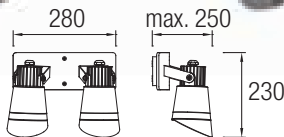

2 x GU-10 max. 50W / max. L= 80mm
Halogen - Fluorescent - LED

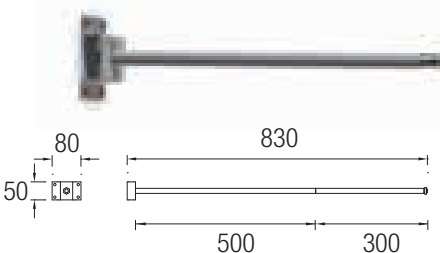
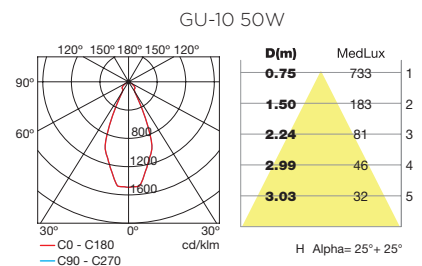

71-9487-34-34 ■

71-9487-Z5-Z5 ■

Accesorio para / Accessory for / Accessoire pour / Zubehör für / Acessório per / Acessório para / Принадлежность для / Akcesorium do 05-9416, 05-9722

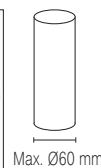

71-9746-05-05 NEW

Accesorio para / Accessory for / Accessoire pour / Zubehör für / Acessório per / Acessório para / Принадлежность для / Akcesorium do 05-9416, 05-9722



Visera incluida
Visor included
Visiere comprise
einschl. Schirm
Visiera inclusa
Visiera inclusa
Прилагается защитный козырек
Ostona w komplecie



La inducción es la fuente de luz idónea para la iluminación de grandes áreas.

- Encendido inmediato y compatible con sensores crepusculares o de presencia.
- Alta eficiencia luminosa (>80 lm/W).
- Lámpara de larga vida útil (>100.000h), permitiendo reducir los costes de mantenimiento frente a las lámparas de descarga.
- Precio competitivo frente a la iluminación LED.
- Numerosas aplicaciones: instalaciones deportivas, parkings, muelles de carga, túneles, iluminación arquitectónica y comercial.

Induction is a suitable light source for the illumination of large areas.

- Immediate turn on and compatible with twilight or presence sensors.
- High luminous efficiency (>80 lm/W).
- Long lamp service life (>100.000 h), enabling you to reduce maintenance costs when comparing this lighting to discharge lamps.
- Competitive price compared to that of LED lighting.
- Numerous applications: sports facilities, parking garages, loading docks, tunnels, architectural and commercial lighting.

L'induction est la source de lumière idéale pour éclairer de vastes surfaces.

- Allumage immédiat et compatible avec capteurs crépusculaires ou de présence.
- Efficacité lumineuse élevée (>80 lm/W).
- Lampe à longue durée de vie utile (>100 000 h), ce qui permet de réduire les coûts d'entretien face aux lampes à décharge.
- Prix compétitif par rapport à l'éclairage LED.
- Nombreuses applications : installations sportives, parkings, quais de chargement, tunnels, éclairage architectural et commercial.

Induktion ist die geeignete Lichtquelle zur Beleuchtung großer Zonen.

- unmittelbares Einschalten und Kompatibilität mit Dämmerungssensoren und Bewegungsmeldern
- hohe Leuchtleistung (>80 lm/W)
- Lampe mit langer Lebensdauer (>100.000 Std.) und dadurch geringere Instandhaltungskosten im Vergleich zu Gasentladungslampen
- Preisvorteil gegenüber LED-Beleuchtung
- Vielfältig einsetzbar: Sportanlagen, Parkplätze, Laderampen, Tunnel, architektonische Beleuchtung und Einzelhandel

L'induzione è la fonte di luce adatta all'illuminazione di grandi aree.

- Accensione immediata e compatibile con sensori crepuscolari o di presenza.
- Alta efficienza luminosa (>80 lm/W).
- Lampada di lunga vita utile (>100.000h) che consente di ridurre i costi di manutenzione se paragonata alle lampade a scarica.
- Prezzo competitivo rispetto all'illuminazione LED.
- Numerose applicazioni: installazioni sportive, parcheggi, banchine di carico, gallerie, illuminazione architettonica e commerciale.

A indução eletromagnética é a fonte de luz ideal para a iluminação de grandes áreas.

- Acendimento imediato e compatível com sensores crepusculares ou de presença.
- Alta eficiência luminosa (>80 lm/W).
- Lámpada de longa vida útil (>100 000h) que permite reduzir os custos de manutenção comparativamente às lâmpadas de descarga.
- Preço competitivo comparativamente à iluminação LED.
- Numerosas aplicações: instalações desportivas, parques de estacionamento, cais, túneis, iluminação arquitetónica e comercial, etc.

Индукция — это источник света, пригодный для освещения больших площадей.

- Мгновенное зажигание и совместимость с сумеречными датчиками или датчиками присутствия.
- Высокая светоотдача (> 80 лм/Вт).
- Лампа с долговечным сроком службы (> 100 000 ч), что позволяет снизить затраты на техническое обслуживание по сравнению с газоразрядными лампами.
- Конкурентная цена по сравнению со светодиодным освещением.
- Широкое использование: спортивные залы, автостоянки, доки, туннели, архитектурное и коммерческое освещение.

Indukcja jest odpowiednim źródłem światła dla oświetlenia dużych powierzchni.

- Natychmiastowe zapalenie i kompatybilne z czujnikami zapadania zmierzchu lub obecności.
- Wysoka wydajność świetlna (>80 lm/W).
- Lampy o długim okresie eksploatacji (>100.000h), pozwalające na zmniejszenie kosztów utrzymania w porównaniu z lampami wyładowcowymi.
- Konkurencyjna cena w porównaniu z oświetleniem ledowym.
- Liczne zastosowania: obiekty sportowe, parkingi, rampy przeładunkowe, tunele, oświetlenie architektoniczne i handlowe.

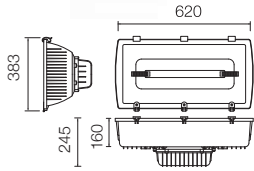

INDUCTION

80-1424-BP-H6 (S) ■

150W 100-240V 50-60Hz 8.290lm^(R)
Cool white 5000K

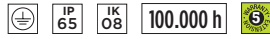

+ 150W



IND 150W
ULOR inst = 0,00%

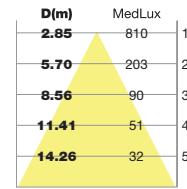
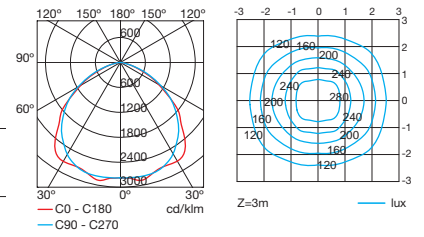

H Alpha= 55° + 55°

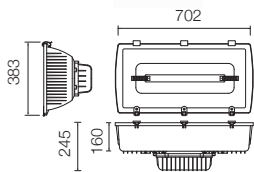

INDUCTION

80-1506-BP-H6 (S) ■

250W 100-240V 50-60Hz 13.850lm^(R)
Cool white 5000K

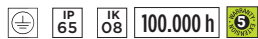

+ 250W



IND 250W
ULOR inst = 0,00%

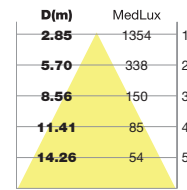
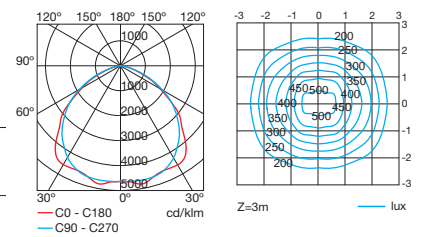

H Alpha= 55° + 55°

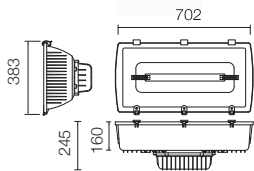

INDUCTION

80-1423-BP-H6 (S) ■

300W 100-240V 50-60Hz 16.050lm^(R)
Cool white 5000K



+ 300W



IND 300W
ULOR inst = 0,00%

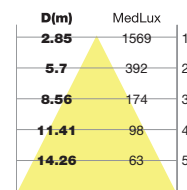
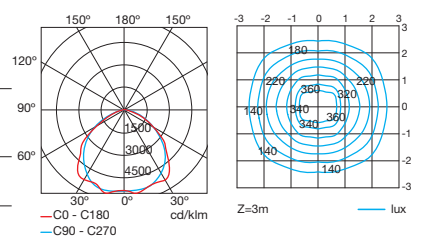

H Alpha= 55° + 55°

Disponibile bajo pedido en otras temperaturas de color.
Available on order in other colour temperatures.
Disponibile sur commande dans d'autres températures de couleur.
Auf Anfrage auch mit anderen Farbtemperaturen lieferbar.
Disponibile su richiesta in altre temperature di colore.
Disponível noutras temperaturas de cor, mediante pedido.
На заказ поставляется других оттенков света.
Dostępny na zamówienie w innych temperaturach koloru.



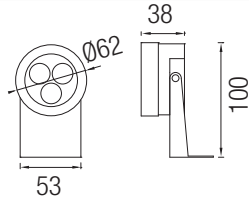

MIDI

05-3358-N3-37

3 LED CREE 350 mA / max. 700 mA max. 7,1W
510lm^(N) Neutral white 4000K

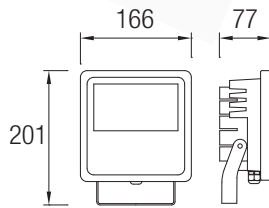
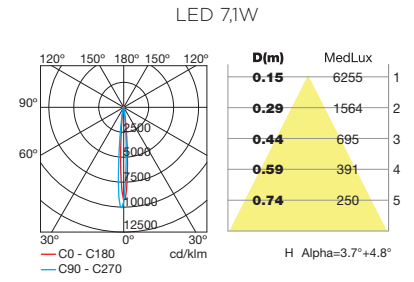
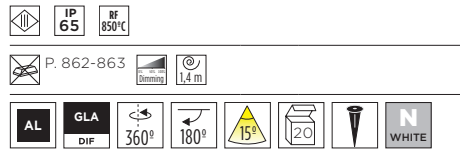

PROY NEW

05-9739-05-37

LED CITIZEN 100-240V 20W 2000 lm^(N)
Warm white 3000K

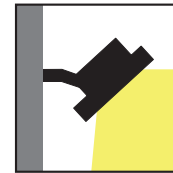
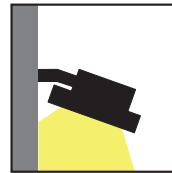
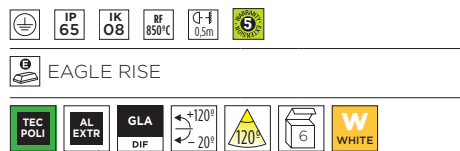





POWELL NEW

05-9731-34-37 ■

9 LED CREE 220-240V 20W 1863lm^(N)
Neutral white 4000K



EAGLE RISE



SKADE

05-9580-34-37 ■

LED PHILIPS FORTIMO 230V 14,5W 850lm^(N)
Neutral white 4000K



LED 14,5W

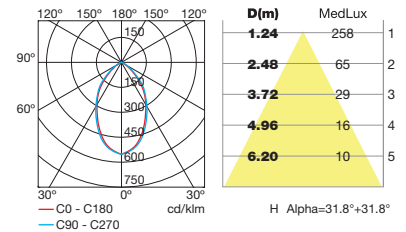

SHULL

05-9652-34-M2 ■ 3000K 1456 lm^(N)

05-9598-34-M2 ■ 4000K 1656 lm^(N)

8 LED CREE 110-240V 17W

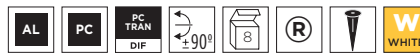

LED 17W

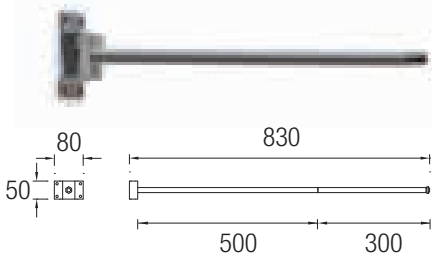
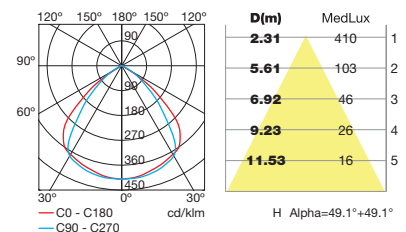

71-9487-34-34 ■

Accesorio para / Accessory for / Accessoire pour / Zubehör für / Accessorio per / Acessório para /
Принадлежность для / Akcesorium do **05-9598, 05-9652**

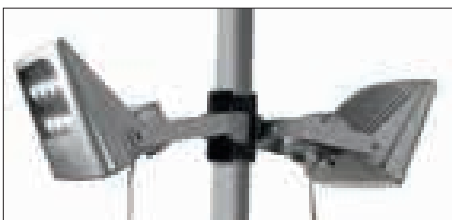

71-9746-05-05 ■ NEW

Accesorio para / Accessory for / Accessoire pour / Zubehör für / Accessorio per / Acessório para /
Принадлежность для / Akcesorium do **05-9598, 05-9652**







ALIEN

05-9296-34-37 ■

05-9296-Z5-37 ■

Par-30 E-27 max. 75W / max. L=90mm Ø=97mm
Halogen - Fluorescent - LED

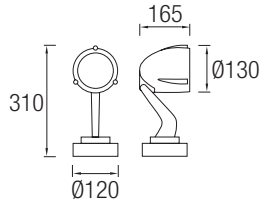
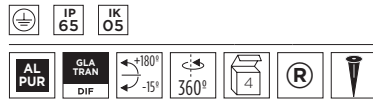

Par-30 75W

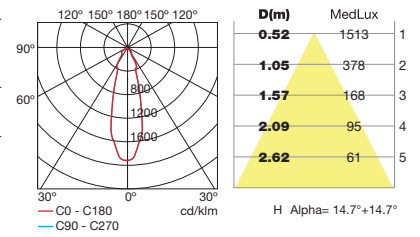

ALIEN

05-9327-34-37 ■

05-9327-Z5-37 ■

GU-10 max. 50W / max. L=65mm
Halogen - Fluorescent - LED

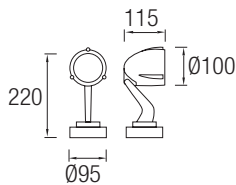

GU-10 50W

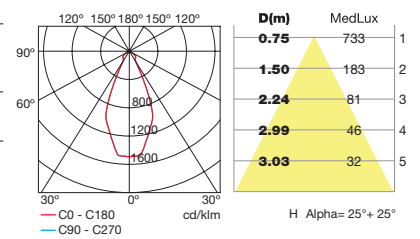

SKADE

05-9107-34-37 ■

05-9107-Z5-37 ■

R7s L=78 max. 150W

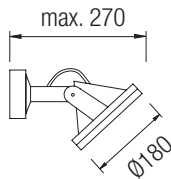
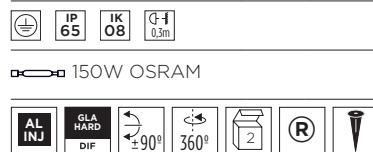

R7s 150W

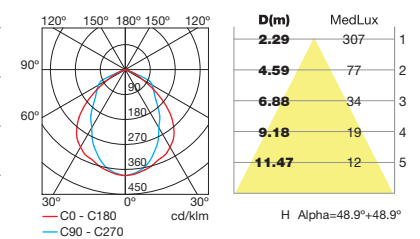

EOLO

05-9122-Y4-37 ■

GU-10 max. 50W / max. L= 70mm
Halogen - Fluorescent - LED

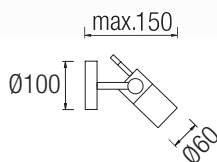
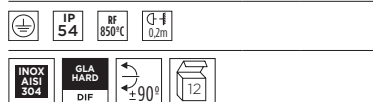

GU-10 50W

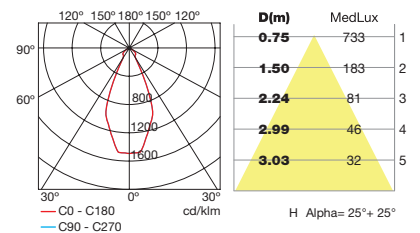





HELIO

- 05-9640-05-37
- 05-9640-14-37
- 05-9640-34-37

GU-10 max. 50W / max. L= 80mm
Halogen - Fluorescent - LED



PHILIPS 50W

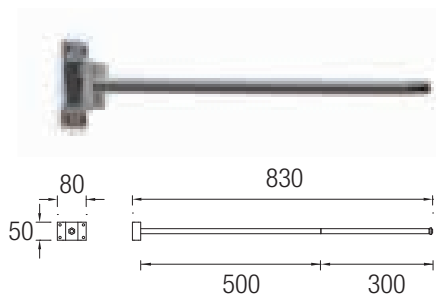
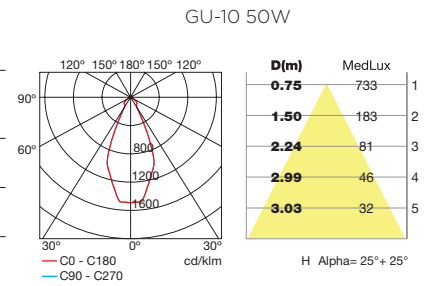
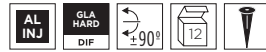

- 71-9487-34-34
- 71-9487-Z5-Z5

Accesorio para / Accessory for / Accessoire pour / Zubehör für / Accessorio per / Acessório para /
Принадлежность для / Akcesorium do **05-9640**



- 71-9746-05-05 NEW

Accesorio para / Accessory for / Accessoire pour / Zubehör für / Accessorio per / Acessório para /
Принадлежность для / Akcesorium do **05-9640**

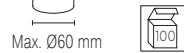

HELIO NEW

- 05-9310-CA-37

GU-10 max. 50W / max. L= 80mm
Halogen - Fluorescent - LED



OSRAM 50W

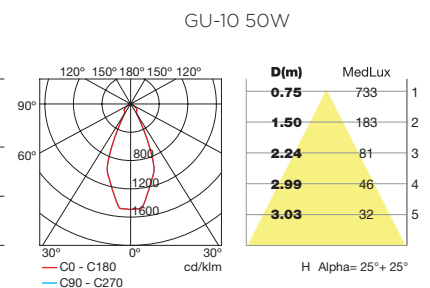
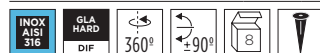



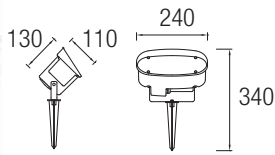

ESPARTA

55-9349-Z5-M3

G24d-3 26W Fluorescent 230V

IP 65 IK 09 BF 850°C

BAG

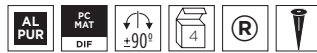

G24d-3 26W

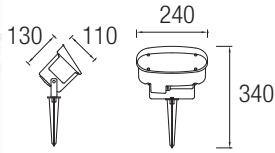
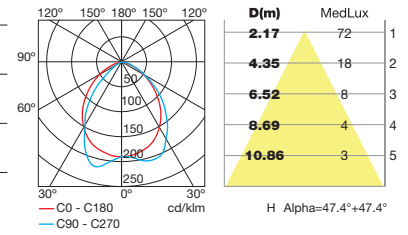

ESPARTA

55-9701-Z5-M3

E-27 max. 23W / max. L=160mm
Fluorescent - LED

IP 65 IK 09 BF 850°C

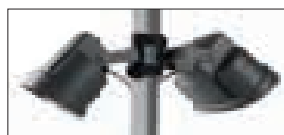

71-9746-05-05

Accesorio para / Accessory for / Accessoire pour / Zubehör für / Accessorio per / Acessório para / Принадлежность для / Akcesorium do dla **55-9349, 55-9701**

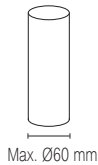

71-9487-Z5-Z5

Accesorio para / Accessory for / Accessoire pour / Zubehör für / Accessorio per / Acessório para / Принадлежность для / Akcesorium do dla **55-9349, 55-9701**

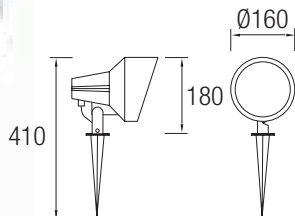
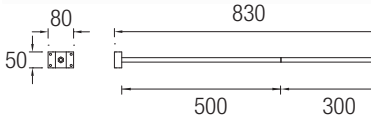

ESPARTA

55-9172-34-37

Par-38 max. 60W / max. L=140mm
Halogen - Fluorescent - LED

IP 54 IK 08 BF 850°C G-F 0.5m

2.5m

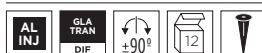

Par-38 60W

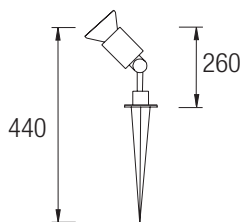
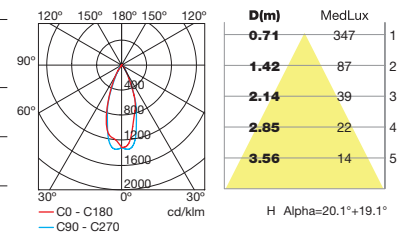

ESPARTA

55-8784-05-05

Par-38 max. 100W
Halogen - Fluorescent - LED

IP 44 BF 850°C G-F 0.5m

2.5m

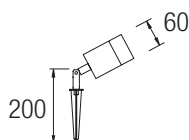
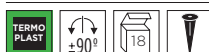

ICARO

55-9191-34-37

GU-10 max. 50W / max. L=75mm
Halogen - Fluorescent - LED

IP 44 BF 850°C G-F 0.5m

OSRAM 50W

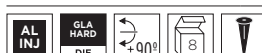

GU-10 50W

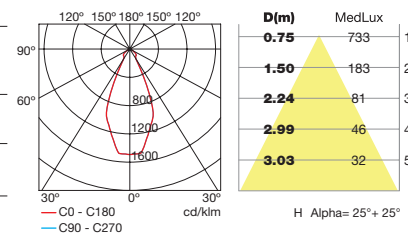



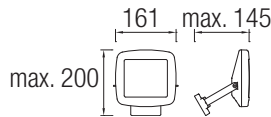

SOLAR NEW

05-9762-05-M2 ■

48 LED 4000mAh 1,8W 140lm^(N)
Neutral white 4000K

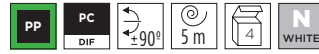

SENSOR CREPUSCULAR. / TWILIGHT SENSOR / CAPTEUR CRÉPUSCULAIRE / DÄMMERUNGSSENSOR. / SENSORE CREPUSCOLARE. / SENSOR CREPUSCULAR. / СУМЕРЕЧНЫЙ ДАТЧИК / CZUJNIK ZAPADANIA ZMIERZCHU.

2 modos: encendido de noche / apagado de día.
2 modes: night time on / day time off
2 modes : allumé la nuit / éteint le jour
2 Betriebsarten: abends/nachts eingeschaltet / tagsüber aus.
2 modalità: acceso di notte / spento di giorno.
2 modos: aceso durante a noite/apagado durante o dia.
2 режима: включено ночью / выключено днем
2 tryby: zapalony nocą / zgaszony w ciągu dnia.

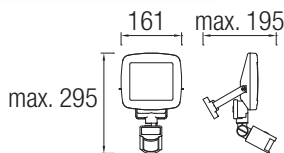

SOLAR NEW

05-9763-05-M2 ■

64 LED 3W 2000mAh 200lm^(N)
Neutral white 4000K

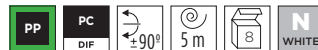

SENSOR PIR. / PIR SENSOR / CAPTEUR PIR / PIR-SENSOR (BEWEGUNGSMELDER). / SENSORE PIR. / SENSOR PIR. / ИНФРАКРАСНЫЙ ДАТЧИК ДВИЖЕНИЯ / CZUJNIK PIR.

3 modos: siempre encendido / automático mediante sensor / apagado.
3 modes: always on / automatic via sensor / off.
3 modes : toujours allumé / automatique par capteur / éteint
3 Betriebsarten: Immer-ein / automatisch mittels Sensor / Aus.
3 modalità: sempre acceso / automatico tramite sensore / spento.
3 modos: sempre aceso/automático com sensor/apagado.
3 режима: постоянно включено / автоматчерез датчик / выключено
3 tryby: zawsze zapalony / samoczynny przy pomocy czujnika / zgaszony.



Incluye controlador digital.
Includes digital controller.
Comprend un contrôleur numérique.
Einschließlich Digitalsteuerung.
Comprende regolatore digitale.
Inclui controlador digital.
В комплект входит цифровой контроллер.
Zawiera cyfrowy nastawnik.

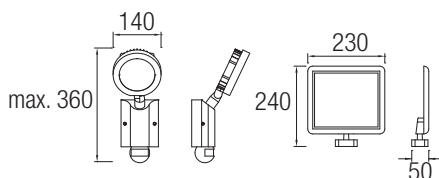

SHAPLEY

05-9707-Z5-M2 ■

4 LED CREE 4W 400lm^(N)
Neutral white 4000K

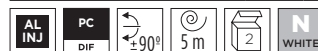

SENSOR PIR. / PIR SENSOR / CAPTEUR PIR / PIR-SENSOR (BEWEGUNGSMELDER). / SENSORE PIR. / SENSOR PIR. / ИНФРАКРАСНЫЙ ДАТЧИК ДВИЖЕНИЯ / CZUJNIK PIR.

3 modos: siempre encendido / automático mediante sensor / apagado.
3 modes: always on / automatic via sensor / off.
3 modes : toujours allumé / automatique par capteur / éteint
3 Betriebsarten: Immer-ein / automatisch mittels Sensor / Aus.
3 modalità: sempre acceso / automatico tramite sensore / spento.
3 modos: sempre aceso/automático com sensor/apagado.
3 режима: постоянно включено / автоматчерез датчик / выключено
3 tryby: zawsze zapalony / samoczynny przy pomocy czujnika / zgaszony.





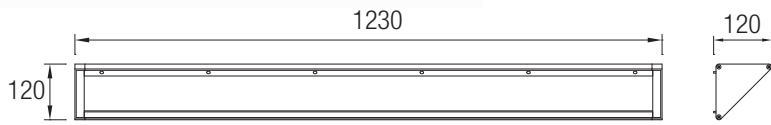

CURIE

05-9662-34-CD ■

T5 28/54W Fluorescent 230V

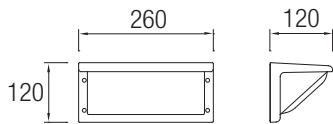

CURIE

05-9408-34-M3 ■

05-9408-Z5-M3 ■

G24d-3 26W Fluorescent 230V



G24d-3 26W

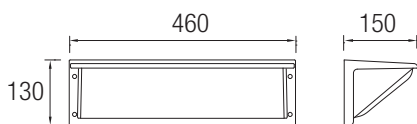
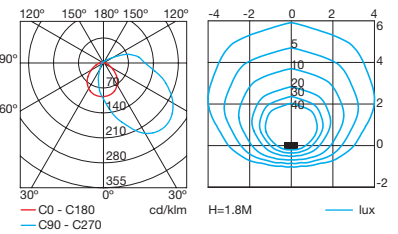

CURIE

05-9457-34-M3 ■

05-9457-Z5-M3 ■

2 x G24d-3 26W Fluorescent 230V



2 x G24d-3 26W

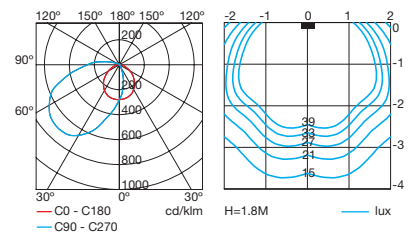



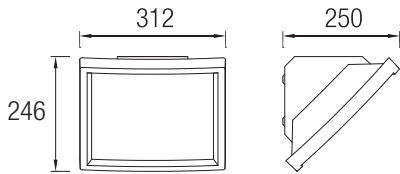

ACCESS NEW

05-9734-34-M1 ■

2 x E-27 max. 18W / max. L=160mm
Fluorescent - LED

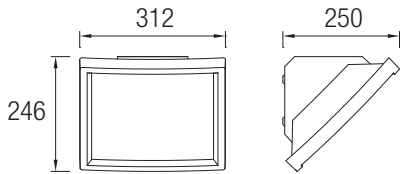

ACCESS NEW

05-9783-34-M1 ■

2 x E-27 max. 18W / max. L=160mm
Fluorescent - LED

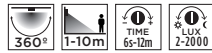

SENSOR DE MICROONDAS.
MICROWAVE SENSOR
CAPTEUR À MICRO-ONDES
MIKROWELLENSENSOR.
SENSORE DI MICROONDE.
SENSOR DE MICRO-ONDAS. МИКРОВОЛНОВЫЙ ДАТЧИК
CZUJNIK MIKROFAL.

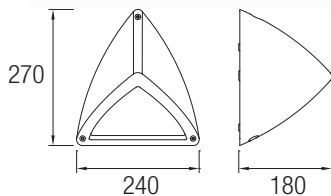

PIRAMID

05-9559-34-B8 ■

E-27 max. 23W / max. L=140mm
Fluorescent - LED





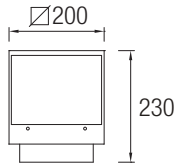
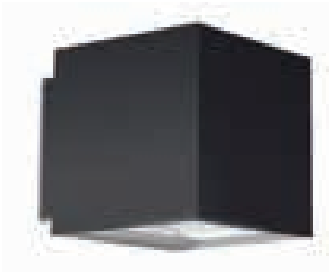

AFRODITA

05-9641-34-37 ■
05-9641-Z5-37 ■

G12 35W HID 230V



BAG



G12 35W

Con cristales lupa.
 With magnifying glasses.
 Avec verres grossissants.
 Mit Lupengläser.
 Con vetri con lente d'ingrandimento.
 Com vidro tipo lupa.
 С увеличительными стеклами.
 Ze szkłami powiększającymi.

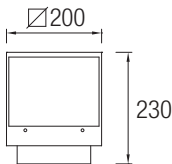
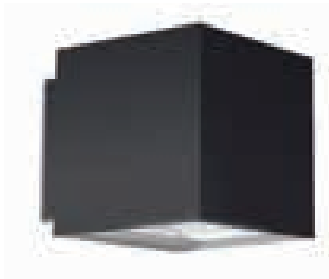
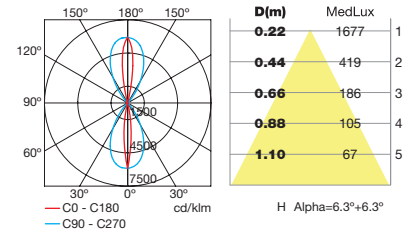

AFRODITA

05-9577-34-37 ■
05-9577-Z5-37 ■

G12 70W HID 230V



BAG



G12 70W

Con cristales lupa.
 With magnifying glasses.
 Avec verres grossissants.
 Mit Lupengläser.
 Con vetri con lente d'ingrandimento.
 Com vidro tipo lupa.
 С увеличительными стеклами.
 Ze szkłami powiększającymi.

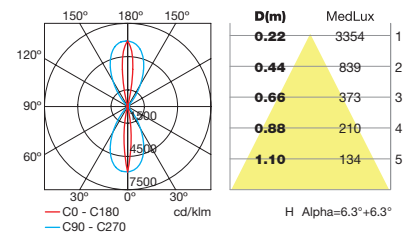

71-9577-05-37 ■

Lente para / Lens / Lentille pour / Linse für / Lente per / Lente para / Линза для / Soczewka dla **05-9577, 05-9641**

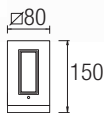
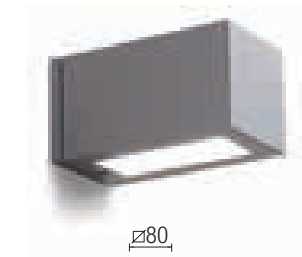

FENIX

05-9129-34-37 ■
05-9129-Z5-37 ■

G9 max. 60W



40W OSRAM



G9 60W

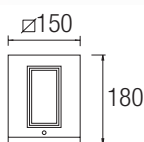
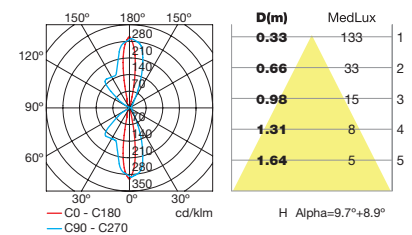

FENIX

05-9159-Z5-37 ■

R7s L=78 max. 150W



150W OSRAM

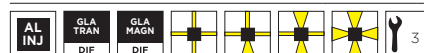

R7s 150W

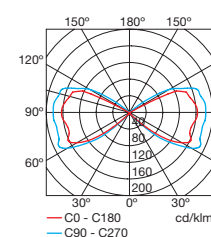

20





WILSON

05-9683-14-T2 NEW

05-9683-34-T2 NEW

05-9683-Z5-T2 ■

6 LED CREE 100-240V 6W 642lm^(N)
Warm white 3000K



EAGLE RISE

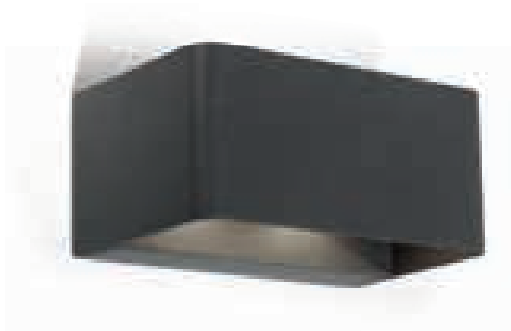
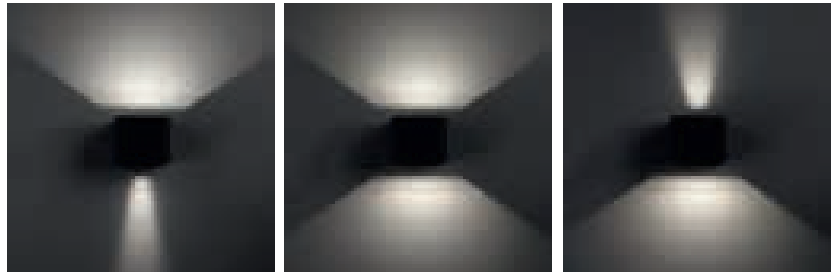
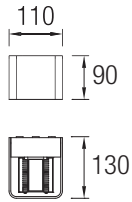
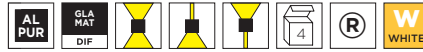

WILSON

05-9684-Z5-T2 ■

12 LED CREE 100-240V 12W 1284lm^(N)
Warm white 3000K



EAGLE RISE

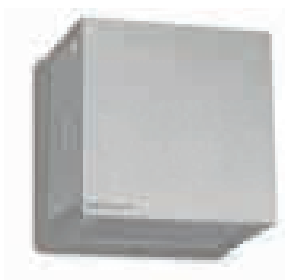
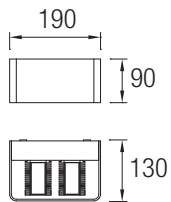

POKER NEW

05-9732-34-37 ■

05-9732-Z5-37 ■

4 LED PHILIPS 100-240V 8W 820lm^(N)
Neutral white 4000K



EAGLE RISE

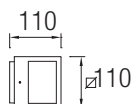



CROWNE PLAZA HOTEL. LIÈGE, BELGIUM.



AFRODITA

05-9531-34-T2

05-9531-Z5-T2

8 LED CREE 100-240V 17W 1656lm^(N)
Neutral white 4000K

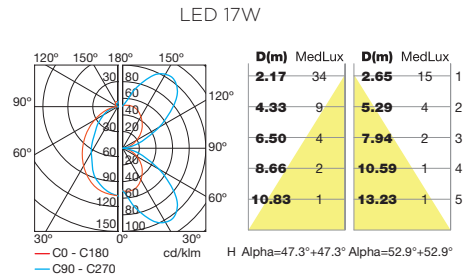
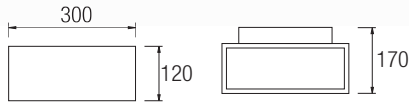
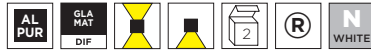

AFRODITA

05-9438-34-37

05-9438-Z5-37

Rx7s 70W HID 230V

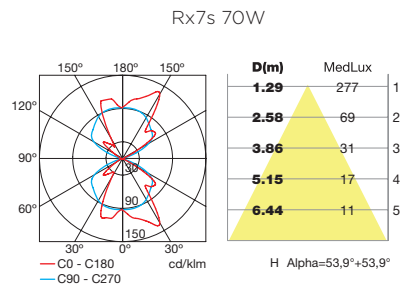
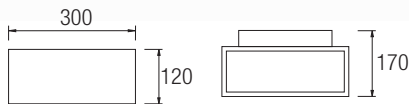

Incluye accesorio reflector. / Includes reflector accessory. /
Accessoire réflecteur fourni. / Einschließlich Zubehör Reflektor. /
Comprende accessorio riflettente. / Inclui acessório refletor. /
Включает отражательную принадлежность. / Zawiera akcesorium odbłyśnik.

AFRODITA

05-9227-34-37

05-9227-Z5-37

Rx7s-24 150W HID 230V

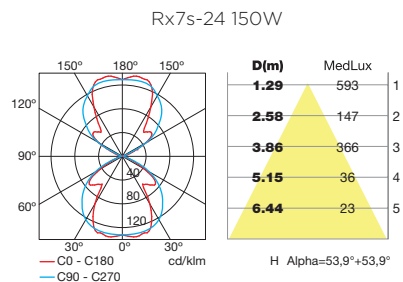
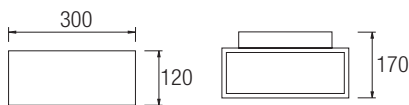

Incluye accesorio reflector. / Includes reflector accessory. /
Accessoire réflecteur fourni. / Einschließlich Zubehör Reflektor. /
Comprende accessorio riflettente. / Inclui acessório refletor. /
Включает отражательную принадлежность. / Zawiera akcesorium odbłyśnik.

AFRODITA

05-9228-14-37

05-9228-34-37

05-9228-Z5-37

2 x G24q-3 26W Fluorescent 230V

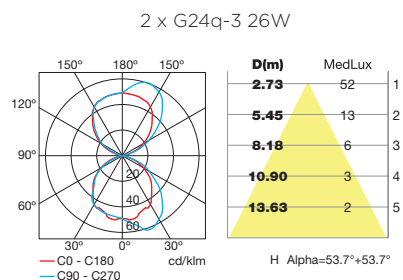
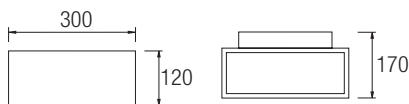

Incluye accesorio reflector. / Includes reflector accessory. /
Accessoire réflecteur fourni. / Einschließlich Zubehör Reflektor. /
Comprende accessorio riflettente. / Inclui acessório refletor. /
Включает отражательную принадлежность. / Zawiera akcesorium odbłyśnik.





ALCOLEA PSYCHIATRIC CENTER. CÓRDOBA, SPAIN.

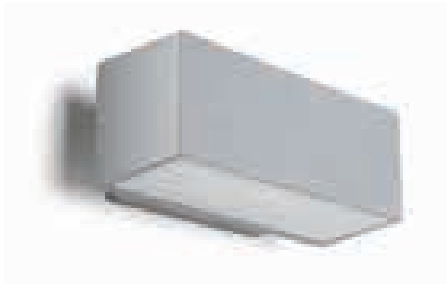

AFRODITA

- 05-9229-14-37
- 05-9229-34-37
- 05-9229-J6-37
- 05-9229-Z5-37

R7s L=78 max. 150W Halogen



Incluye accesorio reflector. / Includes reflector accessory. / Accessoire réflecteur fourni. / Einschließlich Zubehör Reflektor. / Comprende accessorio riflettente. / Inclui acessório refletor. / Включает отражательную принадлежность. / Zawiera akcesorium odbłyśnik.

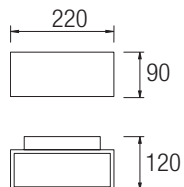

R7s 100W

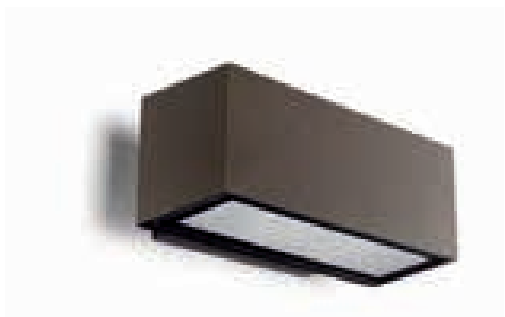
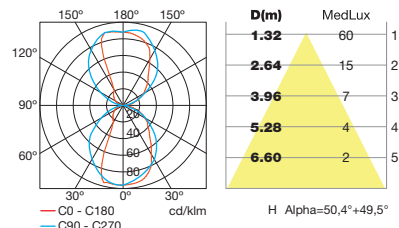

AFRODITA

- 05-9230-14-37
- 05-9230-34-37
- 05-9230-J6-37
- 05-9230-Z5-37

G24d-3 26W Fluorescent 230V



BAG



Incluye accesorio reflector. / Includes reflector accessory. / Accessoire réflecteur fourni. / Einschließlich Zubehör Reflektor. / Comprende accessorio riflettente. / Inclui acessório refletor. / Включает отражательную принадлежность. / Zawiera akcesorium odbłyśnik.

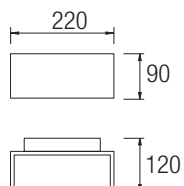

G24d-3 26W

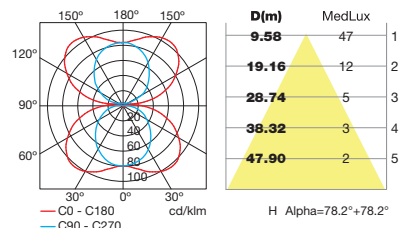

AFRODITA

- 05-9458-34-T2
- 05-9458-J6-T2 (S)
- 05-9458-Z5-T2

8 LED CREE 100-240V 8W 976lm⁽⁸⁰⁾
Neutral white 4000K



EAGLE RISE

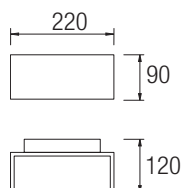

LED 8W

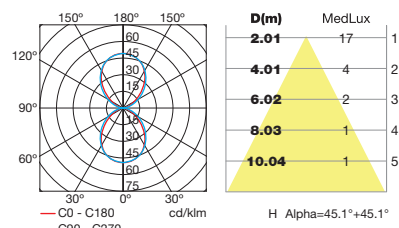



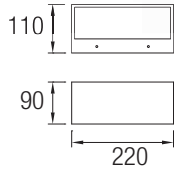
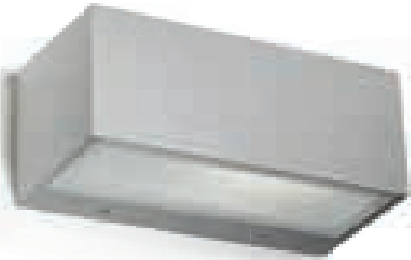

NEMESIS

05-9649-14-T2 **NEW**

05-9649-34-T2

05-9649-Z5-T2

E-27 max. 60W / max. L=155mm
Halogen - Fluorescent - LED

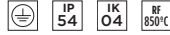

NEMESIS

05-9177-14-B8

05-9177-34-B8

05-9177-J6-B8

05-9177-Z5-B8

R7s L=78 max. 100W



Set completo para uso con PL G24d-1;/ Full set for use with PL G24d-1;/ Set complet à utiliser avec PL G24d-1;/ Komplettsatz für Verwendung mit PL G24d-1;/ Per uso con PL G24d-1 ordinare;/ Set completo para uso com PL G24d-1;/ Полный набор для использования с PL G24d-1;/ Peřen komplet dia użycia z PL G24d-1:

05-9177 + 71-8969-00-00

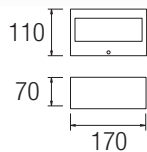
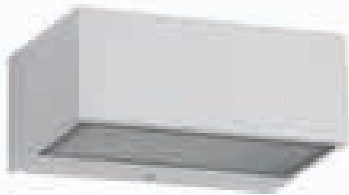
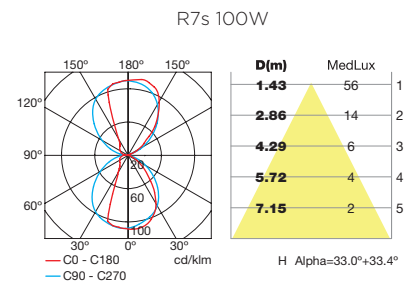

71-8969-00-00

Reactancia para / Ballast for / Ballast pour / Vorschatgerät für / Reattanza per / Reactància para / Реактивное сопротивление для / Statecznik do PL-G24d-13W 230V



LED KIT **NEW**

71-9747-00-00 Warm white 3000K 715 lm⁰⁰

71-9781-00-00 Neutral white 4000K 754 lm⁰⁰

20 LED SAMSUNG 100-240V 5W



SELF

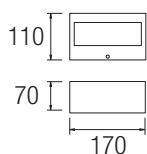

NEMESIS

05-9636-34-B8

05-9636-Z5-B8

G24d-1 13W Fluorescent 230V

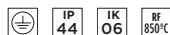



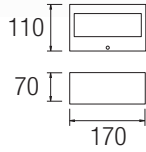

NEMESIS

05-9629-CA-B8 ■

R7s L=78 max. 100W Halogen

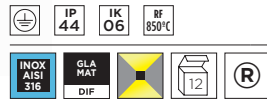

R7s 100W

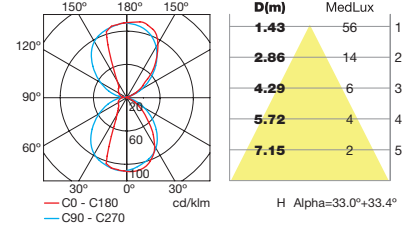

LED KIT NEW

71-9747-00-00 Warm white 3000K 715 lm⁽ⁿ⁾

71-9781-00-00 Neutral white 4000K 754 lm⁽ⁿ⁾

20 LED SAMSUNG 100-240V 5W

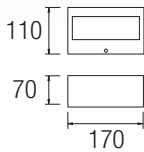

NEMESIS

05-9637-CA-B8 ■

G24d-1 13W Fluorescent 230V

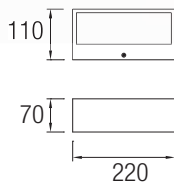
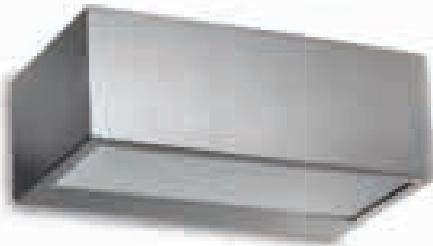
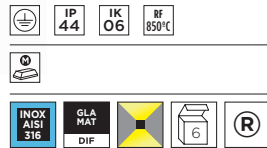

NEMESIS

05-9675-CA-B8 ■

G24d-2 18W Fluorescent 230V

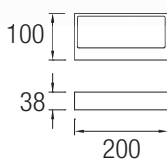
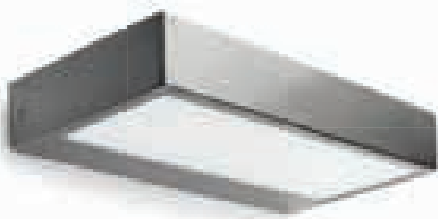
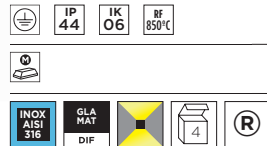

NEMESIS NEW

05-9776-CA-G5 ■

60 LED 110-230V 3,4W 300lm⁽ⁿ⁾
Warm white 3000K





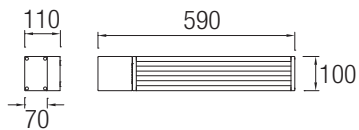

TINA

05-9472-34-M3 ■

2G11 36W 230V



Incluye accesorio reflector. / Includes reflector accessory. /
 Accessoire réflecteur fourni. / Einschließlich Zubehör Reflektor. /
 Comprende accessorio riflettente. / Inclui acessório refletor. /
 Включает рефлекторную принадлежность. / Zawiera akcesorium odbłyśnik.



2G11 36W

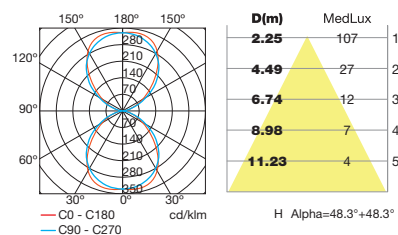

AFRODITA NEW

05-9773-34-37 ■

8 LED CREE 220-240V 17W 1656lm^(N)
 Warm white 3000K

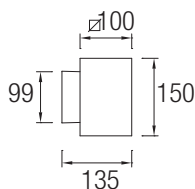

AFRODITA

05-9368-14-37 □

05-9368-34-37 ■

05-9368-Z5-37 ■

2 x Par-30 E-27 max. 75W / max. L=100mm
 Halogen - Fluorescent - LED

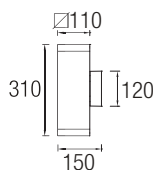

2 x Par-30 75W

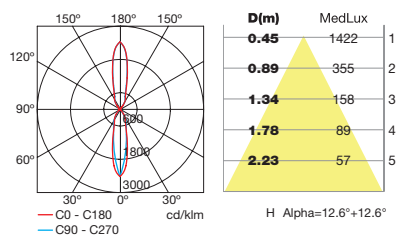

AFRODITA

05-9369-34-37 ■

05-9369-Z5-37 ■

G12 70W HID 230V



G12 70W

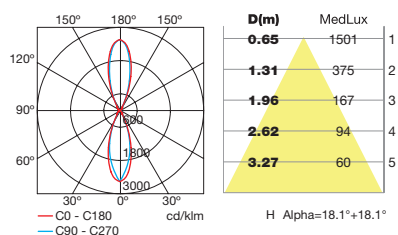

Incluye reflector simple y doble. / Includes single and double reflector. / Comprend un réflecteur simple et double. / Einfacher und doppelter Reflektor enthalten. / Comprende un riflettore semplice e doppio. / Inclui refletor simples e duplo. / Комплект включает простой и двойной отражатели. / Zawiera odbłyśnik pojedynczy i podwójny.

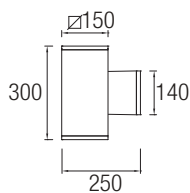



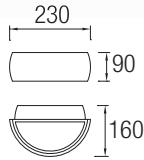

DELFOS

05-9650-34-T2 ■

E-27 max. 60W / max. L=130mm
Halogen - Fluorescent - LED



Incluye accesorio reflector. / Includes reflector accessory. / Accessoire réflecteur fourni. / Einschließlich Zubehör Reflektor. / Comprende accessorio riflettente. / Inclui acessório refletor. / Включает отражательную принадлежность. / Zawiera akcesorium odbłyśnik.

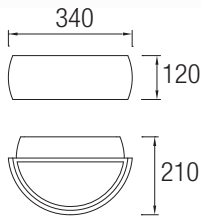

DELFOS

05-9469-34-T2 ■

2 x G24q-3 26W Fluorescent 230V



BAG



Incluye accesorio reflector. / Includes reflector accessory. / Accessoire réflecteur fourni. / Einschließlich Zubehör Reflektor. / Comprende accessorio riflettente. / Inclui acessório refletor. / Включает отражательную принадлежность. / Zawiera akcesorium odbłyśnik.

2 x G24q-3 26W

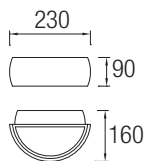
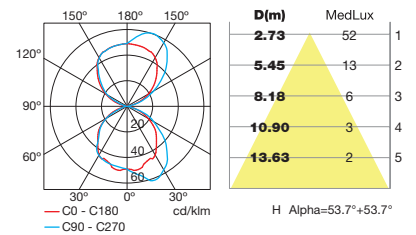

DELFOS

05-9470-34-T2 ■

05-9470-Z5-T2 ■

GX24d-3 26W Fluorescent 230V



BAG



Incluye accesorio reflector. / Includes reflector accessory. / Accessoire réflecteur fourni. / Einschließlich Zubehör Reflektor. / Comprende accessorio riflettente. / Inclui acessório refletor. / Включает отражательную принадлежность. / Zawiera akcesorium odbłyśnik.

G24d-3 26W

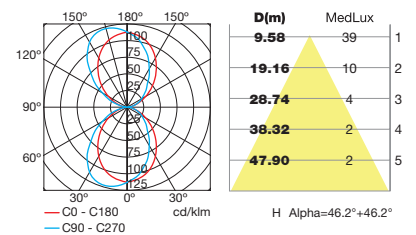



CZARNY POTOK HOTEL. KRYNICA-ZDRÓJ, POLAND.

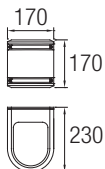

NEO

05-9573-34-T2 ■

05-9573-Z5-T2 ■

E-27 max.150W / max. L=165mm

Halogen - Fluorescent - LED



PL 23W

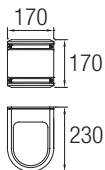
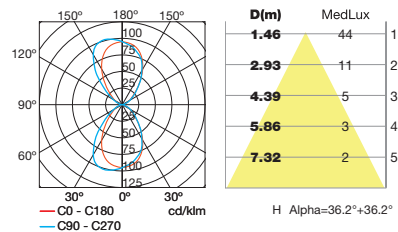

NEO

05-9574-34-37 ■

05-9574-Z5-37 ■

G12 35W HID 230V



G12 35W

Con cristales lupa.
With magnifying glasses.
Avec verres grossissants.
Mit Lupenglas.
Con vetri con lente d'ingrandimento.
Com vidro tipo lupa.
С увеличительными стеклами.
Ze szklami powiększającymi.



71-9574-05-37 ■

Lente para / Lens for / Lentille pour / Linse für / Lente per / Lente para / Линза для / Soczewka dla **05-9574**

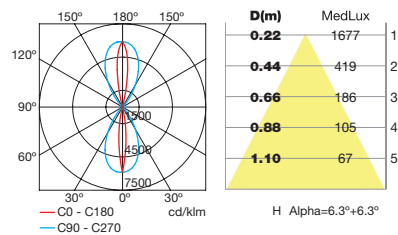



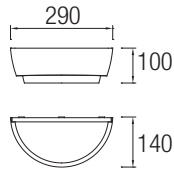

GALILEI

05-9409-34-M3 ■

E-27 max. 23W max. L=200mm Ø=52mm
Fluorescent - LED

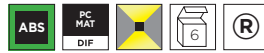

PL 23W

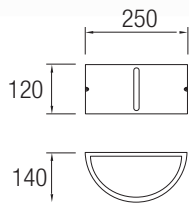
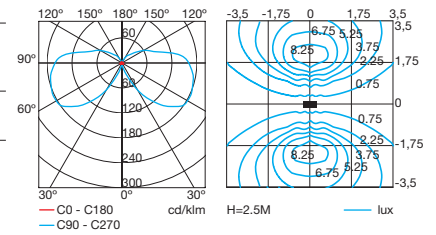

ATENA

05-9131-14-M3 □

05-9131-34-M3 ■

05-9131-Z5-M3 ■

E-27 max. 75W / max. L=167mm Ø=51mm
Halogen - Fluorescent -LED

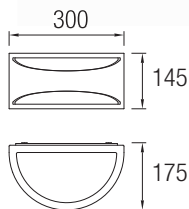
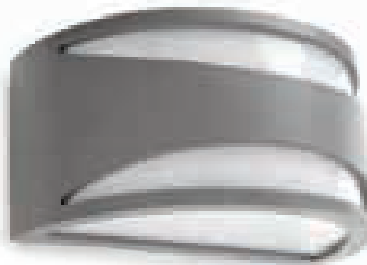

NAPOLI NEW

05-9735-34-M1 ■

E-27 max. 23W
Halogen - Fluorescent -LED

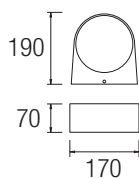

NEMESIS

05-9123-34-B8 ■

05-9123-Z5-B8 ■

E-27 max. 60W / max. L=117mm Ø=45mm
Halogen - Fluorescent -LED



PL 15W

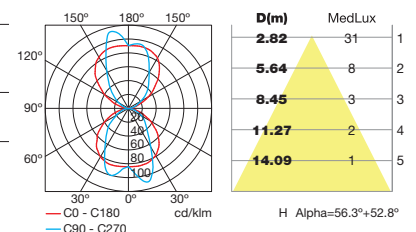



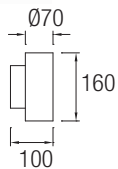

TERRY

05-9719-34-37

2 LED CREE 100-240V 4,5W 414lm^(N)
Neutral white 4000K

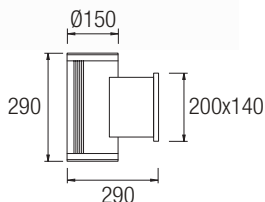

AFRODITA

05-9204-34-B8

G12 70W HID 230V



Include reflector simple y doble. / Includes single and double reflector. /
Comprend un réflecteur simple et double. / Einfacher und doppelter
Reflektor enthalten. / Comprende un riflettore semplice e unodoppio. /
Inclui refetor simples e duplo. / Комплект включает простой и
двойной отражатели. / Zawiera odbłyśnik pojedynczy i podwójny.

G12 70W

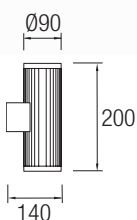
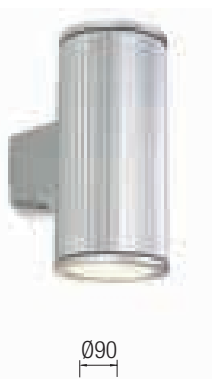
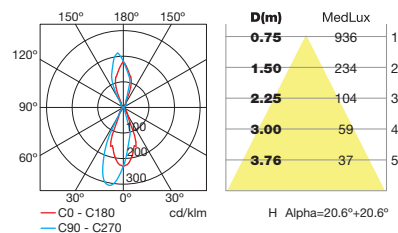

TEMIS

05-9146-34-T2

2 x GU-10 max. 50W / max. L=65mm
Halogen - Fluorescent - LED



GU-10 50W

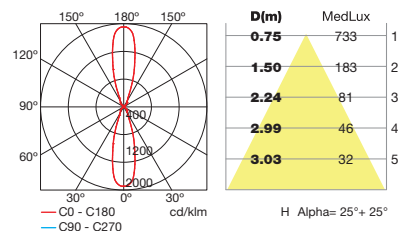





NEMESIS NEW

05-9753-CA-CD ■

16 LED SAMSUNG 100-240V 4W 572lm^(N)
Warm white 3000K



SELF

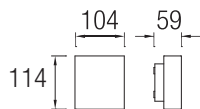

MERTON

05-9601-34-M1 ■ (S)

2 LED CREE 100-240V 2W 244lm^(N)
Neutral white 4000K



EAGLE RISE

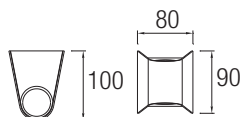

LED 2W

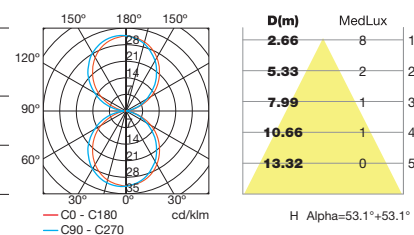

SELENE

05-9234-18-37 ■
05-9234-34-37 ■

2 x GU-10 max. 50W / max. L=65mm
Halogen - Fluorescent - LED



2 x OSRAM 50W



P. 601

GU-10 50W

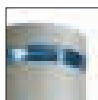
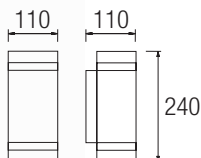
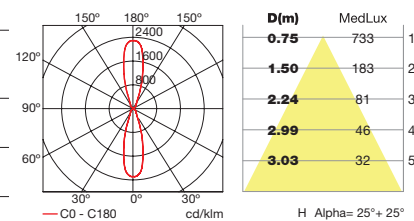

Difusor de PMMA azul de cortesia para acabado 34. / Difusor de PMMA amarillo de cortesia para acabado 18.
Blue courtesy PMMA diffuser for 34 finish. / Yellow courtesy PMMA diffuser for 18 finish.
Diffuseur bleu en PMMA fourni pour finition 34. / Diffuseur jaune en PMMA fourni pour finition 18.
Blauer PMMA-Difusor inklusive für Farbe 34. / Gelber PMMA-Difusor inklusive für Farbe 18.
Difusore di cortesia in PMMA azzurro disponibile per la rifinitura 34. / Difusore di cortesia in PMMA giallo disponibile per la rifinitura 18.
Difusor de PMMA azul de oferta para acabamento 34. / Difusor de PMMA amarelo de oferta para acabamento 18.
Голубой рассеиватель из PMMA в подарок для модели 34. Желтый рассеиватель из PMMA в подарок для модели 18.
Niebieski dyfuzor pomocniczy PMMA dla wykończenia 34. / Żółty dyfuzor pomocniczy PMMA dla wykończenia 18.

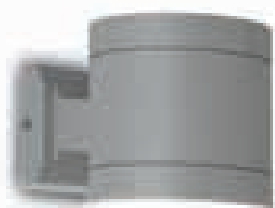

SELENE

05-9309-34-37 ■

G9 max. 60W



40W OSRAM



P. 601

G9 60W

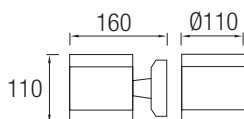
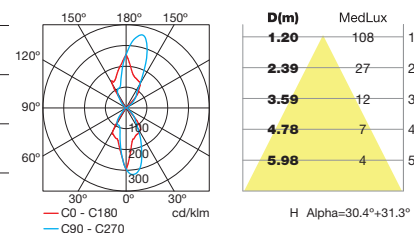

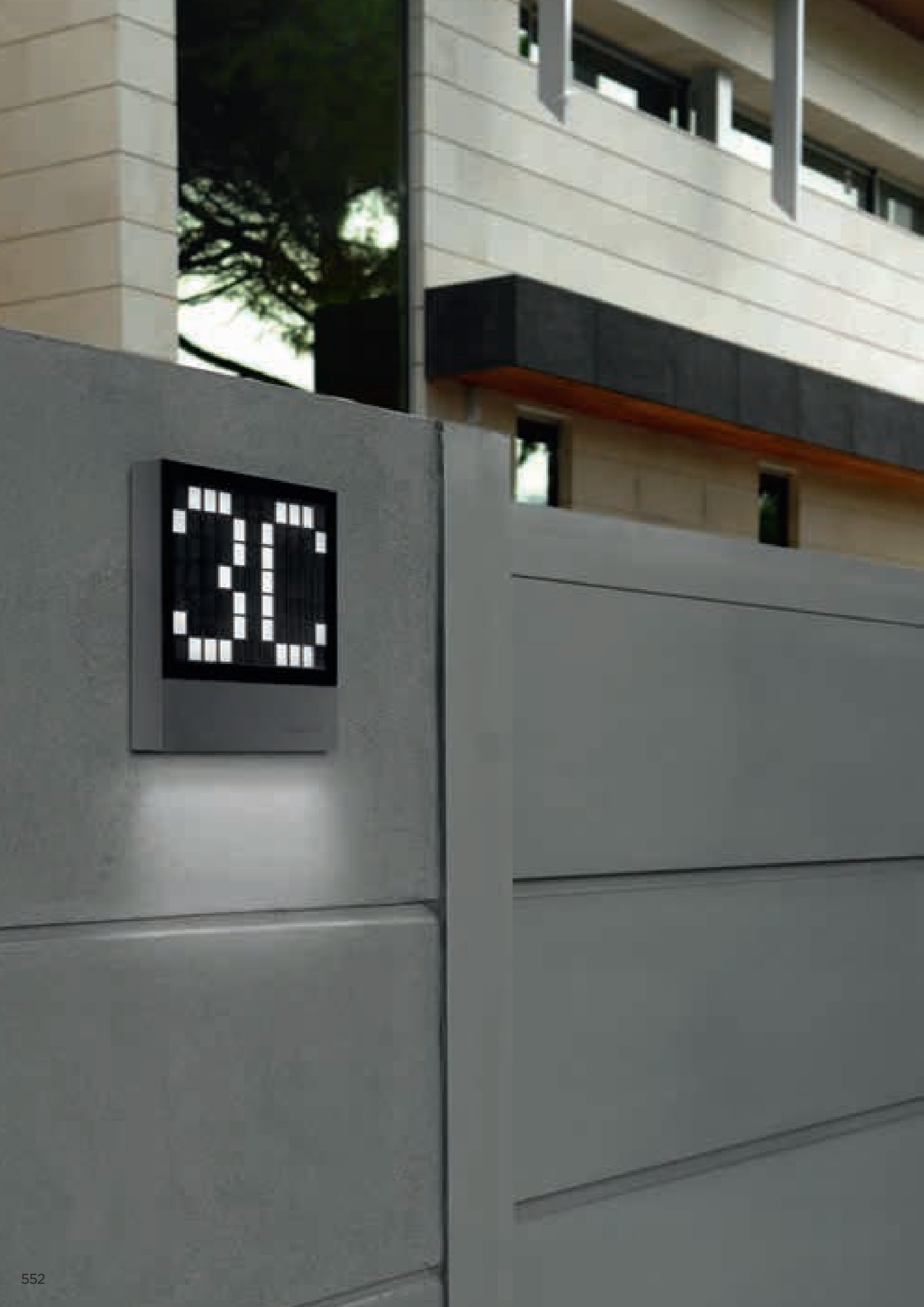



LOTTERY NEW

05-9726-Z5-37 ■

60 LED 100-240V 3,2W 420lm⁽ⁿ⁾
Neutral white 4000K



EAGLE RISE

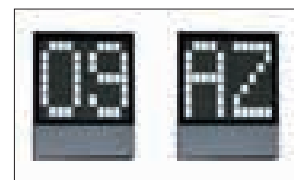

Incluye manual para crear números y letras.
Includes manual for creating numbers and letters.
Comprend un manuel pour la création de chiffres et de lettres.
Einschließlich Vorlage zur Herstellung von Zahlen und Buchstaben.
Include un manuale per creare numeri e lettere.
Inclui manual para criar números e letras.
Включает руководство по созданию цифр
Zawiera podręcznik dla tworzenia numerów i liter.

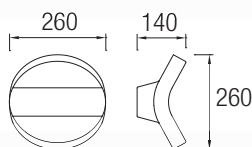

LUA

05-9471-Z5-T2 ■

G24d-3 26W Fluorescent 230V



G24d-3 26W

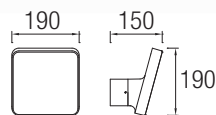
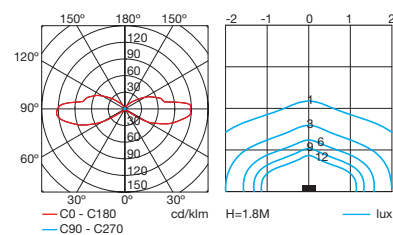

PILE

05-9555-34-M3 ■ (S)

4 LED CREE 100-240V 4W 488lm⁽ⁿ⁾
Neutral white 4000K



EAGLE RISE



LED 4W

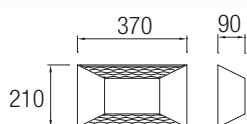
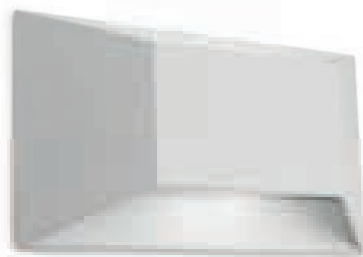
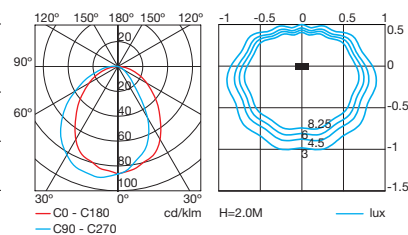

PASTEUR

05-9456-14-M3 □

05-9456-Z5-M3 ■

2 x G24d-2 18W Fluorescent 230V





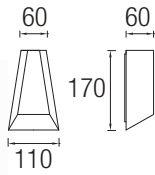

TAYLOR

05-9592-34-37 ■

2 LED CREE 100-240V 2W 244lm⁽²⁾
Neutral white 4000K

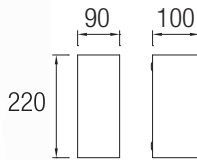
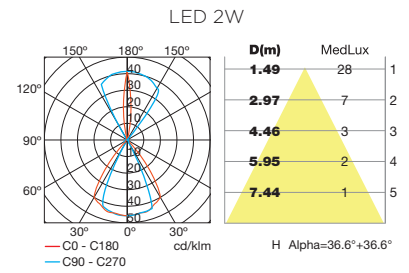

ALVIN NEW

05-9725-34-T2 ■

2 x GU-10 max. 35W / max. L=70mm
Halogen - Fluorescent - LED

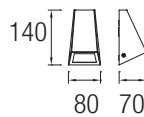

ANGLE

05-9565-Z5-B8 ■

GU-10 max. 35W / max. L=70mm
Halogen - Fluorescent - LED

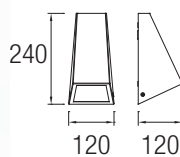
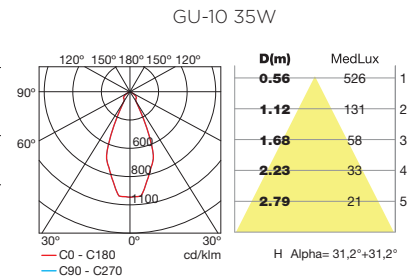

ANGLE

05-9566-Z5-B8 ■

E-27 max. 60W / max. L=170mm
Halogen - Fluorescent - LED





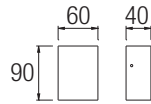

TAYLOR

05-9594-14-37



05-9594-34-37



LED CREE 100-240V 2,2W 207lm^(N)
Neutral white 4000K



LED 2,2W

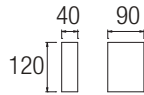
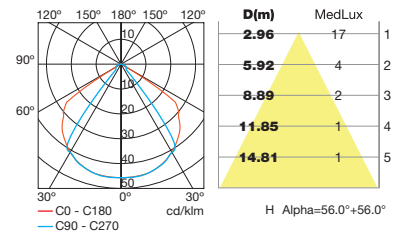

TAYLOR

05-9593-34-37



2 LED CREE 100-240V 4,5W 414lm^(N)
Neutral white 4000K

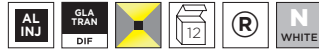

LED 4,5W

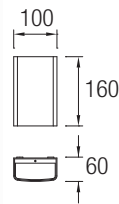
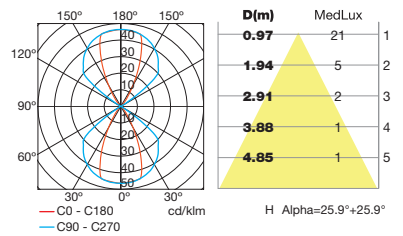

CLOUS

05-9679-34-B8



NEW

05-9679-Z5-B8



6 LED CREE 100-240V 6W 642lm^(N)
Warm white 3000K

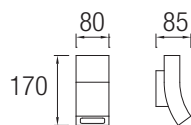

KARMAN

NEW

05-9752-34-CD



12 LED OSRAM 110-230V 7W 720lm^(N)
Warm white 3000K





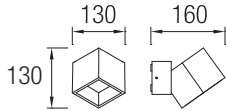
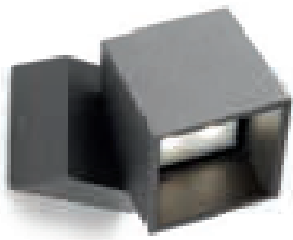

CUBUS

05-9685-Z5-T2

5 LED CREE 100-240V 5W 535lm⁽ⁿ⁾
Warm white 3000K

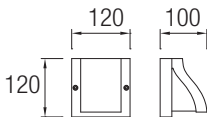
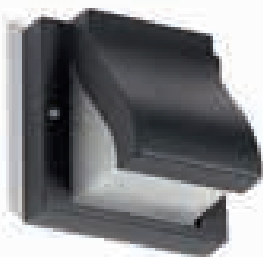

VELTMAN

05-9591-Z5-B8

3 LED CREE 100-240V 3W 366lm⁽ⁿ⁾
Neutral white 4000K

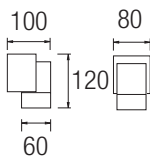
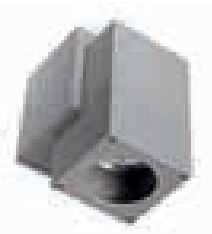

ICARO

05-9190-34-37

GU-10 max. 50W / max. L=75mm
Halogen - Fluorescent - LED

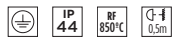

GU-10 50W

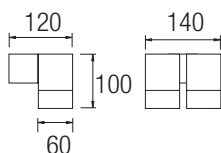
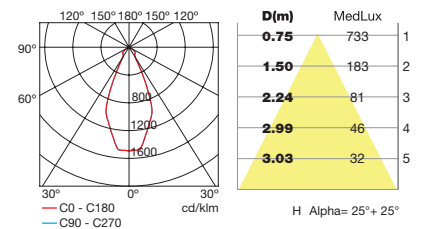

ICARO

05-9191-34-37

2 x GU-10 max. 50W / max. L=75 mm
Halogen - Fluorescent - LED

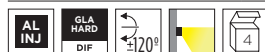

GU-10 50W

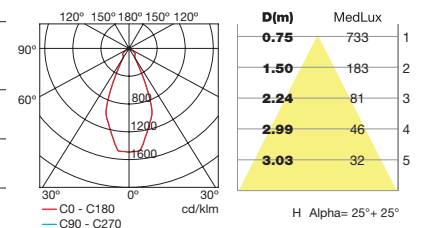



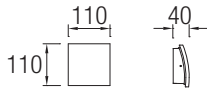

SURF

05-9483-34-37

LED CREE 100-240V 2,3W 187lm^(N)
Neutral white 4000K



EAGLE RISE



Montaje en superficie./ Surface mounted./ Montage en surface./
Aufbaumontage./ Montaggio in superficie./ Montagem à superficie./
Монтаж на поверхности./ Montaż na powierzchni.

LED 2,3W

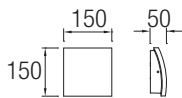
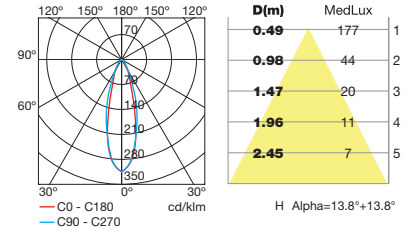

SURF

05-9484-34-37

LED CREE 100-240V 4,6W 374lm^(N)
Neutral white 4000K



EAGLE RISE



Montaje en superficie./ Surface mounted./ Montage en surface./
Aufbaumontage./ Montaggio in superficie./ Montagem à superficie./
Монтаж на поверхности./ Montaż na powierzchni.

LED 4,6W

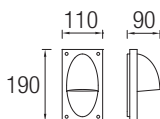
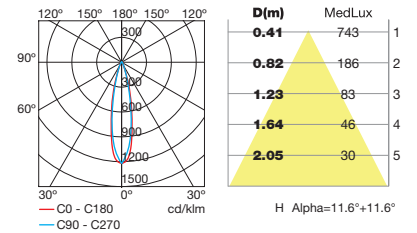

ALFA

05-9344-J6-T2

05-9344-34-T2

GU-10 max. 50W / max. L=65mm
Halogen - Fluorescent - LED



OSRAM 50W



Montaje en superficie./ Surface mounted./ Montage en surface./
Aufbaumontage./ Montaggio in superficie./ Montagem à superficie./
Монтаж на поверхности./ Montaż na powierzchni.

GU-10 50W

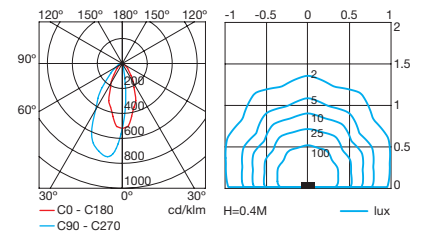



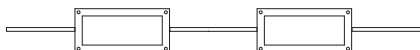
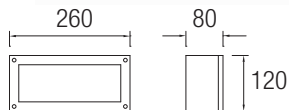

MICENAS

05-9648-34-B8

G24d-3 26W Fluorescent 230V

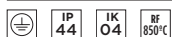

Montaje en superficie./ Surface mounted./ Montage en surface./
Aufbaumontage./ Montaggio in superficie./ Montagem à superfície./
Монтаж на поверхности./ Montaż na powierzchni.

G24d-3 26W

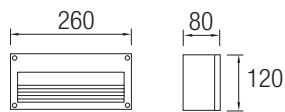
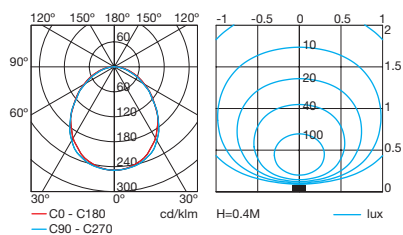

MICENAS

05-9315-34-B8

05-9315-25-B8

G24d-3 26W Fluorescent 230V



Montaje en superficie./ Surface mounted./ Montage en surface./
Aufbaumontage./ Montaggio in superficie./ Montagem à superfície./
Монтаж на поверхности./ Montaż na powierzchni.

G24d-3 26W

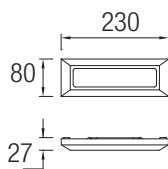
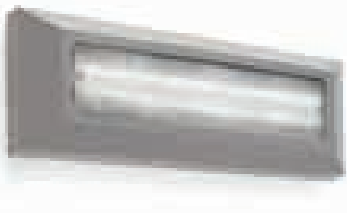
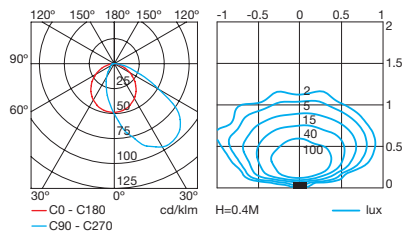

KÖSSEL NEW

05-9779-34-M2

44 LED 220-240V 4W 396lm⁽ⁿ⁾
Warm white 3000K



Montaje en superficie./ Surface mounted./ Montage en surface./
Aufbaumontage./ Montaggio in superficie./ Montagem à superfície./
Монтаж на поверхности./ Montaż na powierzchni.

Difusor prismatizado para evitar deslumbramiento.
Prismatic diffuser to prevent glare.
Diffuseur prismatisé anti-éblouissement.
Prismatisierter Diffusor als Blendschutz.
Diffusore prismatizzato per evitare abbagliamento.
Difusor prismático para evitar o encandearmento.
Призматический рассеиватель для избежания ослепления.
Przmatyczny dyfuzor dla uniknięcia oślepienia.

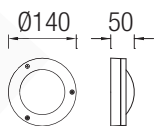

GAP

05-9681-Z5-B8

36 LED 100-240V 3W 288lm⁽ⁿ⁾
Neutral white 4000K



Montaje en superficie./ Surface mounted./ Montage en surface./ Ober-
flächenmontage./ Montaggio in superficie./ Montagem à superfície./
Монтаж на поверхности./ Montaż na powierzchni.

29





CORNER

05-9687-14-M1 □

25 LED 110-230V 3,5W 370lm^(N)
Warm white 3000K

IP 44 BF 850°C



AL INJ PC OPAL DIF 8 R W WHITE



SHARPE

05-9602-34-M1 ■

3 LED CREE 100-240V 3W 366lm^(N)
Neutral white 4000K

IP 44 BF 850°C

EAGLE RISE

AL INJ PC OPAL DIF 4 N WHITE

P. 705

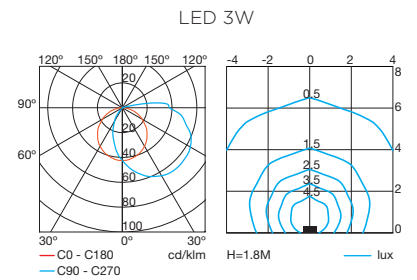

WALKER

05-9595-34-M3 ■ (S)

3 LED CREE 100-240V 6W 621lm^(N)
Neutral white 4000K

IP 44 BF 850°C



AL INJ PC MAT DIF 8 N WHITE

P. 705

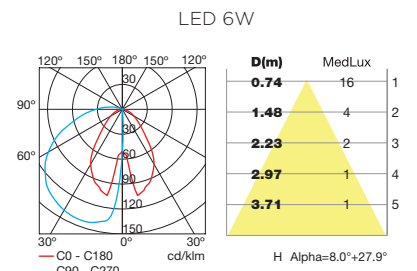



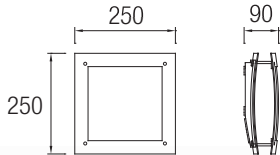

DARWIN

05-9444-Z5-CD ■

E-27 max. 23W / max. L=180mm Ø=60mm
Fluorescent - LED

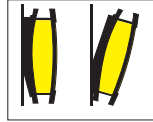

2 posiciones de instalación.
2 installation positions.
2 positions d'installation.
2 Einstellungen.
2 posizioni d'installazione
2 posições de instalação.
2 установочных положения
2 pozycje montażu

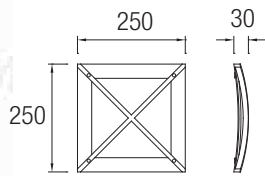
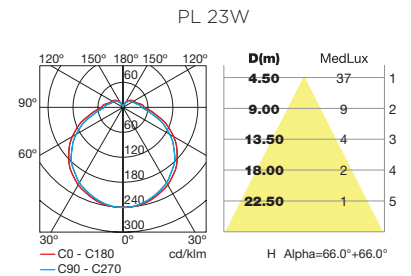

DARWIN

71-9445-Z5-Z5 ■

Accesorio para / Accessory for / Accessoire pour
/ Zubehör für / Accessorio per / Acessório para /
Принадлежность для / Akcesorium do **05-9444**

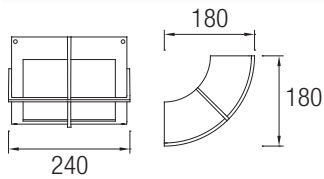

WINDOWS

05-9410-Z5-B8 ■

GX24d-3 26W Fluorescent 230V

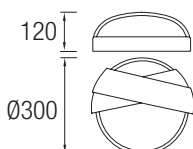
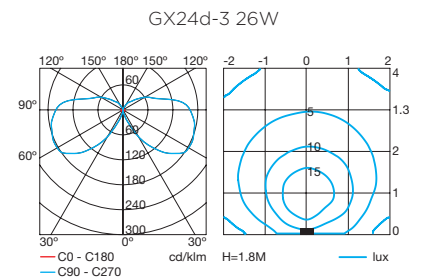
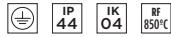

ECLIPSE

05-9300-34-M3 ■ (S)

05-9300-Z5-M3 ■ (S)

2 x E-27 max. 40W / max. L=165mm
Halogen - Fluorescent - LED

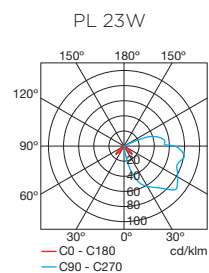



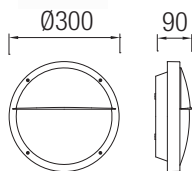

OPAL

05-9677-14-M1 □

2 x E-27 max. 18W / max. L=165mm
Fluorescent - LED



Base translúcida para recrear un efecto de luz decorativo en la superficie.

Traslucent base to create a decorative light effect on the surface.

Socle translucide pour recréer un effet de lumière décoratif en surface.

Durchscheinende Rückseite zur Schaffung von dekorativen Lichteffekten.

Base translúcida per ricreare un effetto di luce decorativa in superficie.

Base translúcida para recriar um efeito de luz decorativo na superfície.

Полупрозрачная основа для создания декоративного светового эффекта на поверхности.

Półprzezroczysta podstawa dla wytworzenia efektu światła dekoracyjnego na powierzchni.

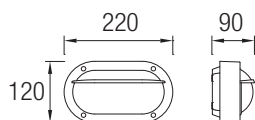

BASIC

05-9544-Z5-M3 ■

E-27 max. 16W / max. L=145mm Ø60mm
Fluorescent - LED



PL 18W

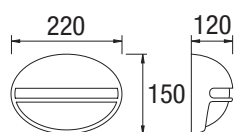
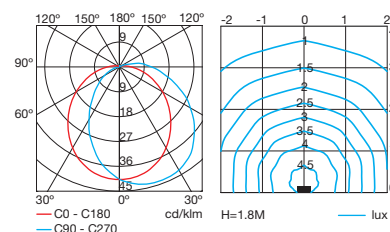

ZEUS

05-8751-34-M3 ■

05-8751-05-M3 ■

E-27 max. 60W / max. L=100mm Ø=45
Halogen - Fluorescent - LED



ZEUS

05-8729-34-M3 ■

05-8729-05-M3 ■

E-27 max. 100W / max. L=167mm
Halogen - Fluorescent - LED

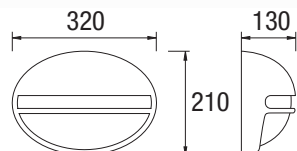



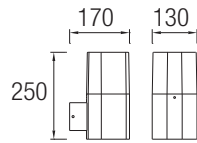

MANDELA

05-9605-Z5-M1 ■

E-27 max. 40W / max. L=150mm
Halogen - Fluorescent - LED

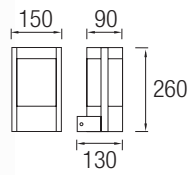

HEBE

05-9238-34-M3 ■

E-27 max. 100W / max. L=167mm
Halogen - Fluorescent - LED

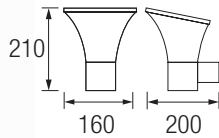
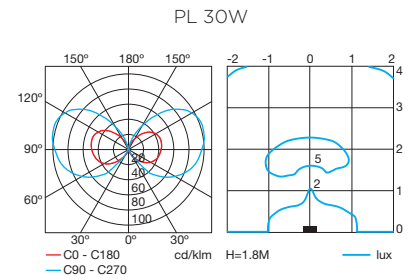

SUZUKI

05-9715-Z5-M1 ■

E-27 max. 18W / max. L=150mm
Fluorescent - LED

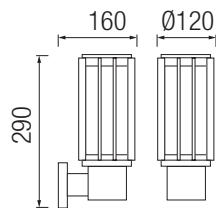

SIMS

05-9717-34-M1 ■

E-27 max. 30W / max. L=165mm
Fluorescent - LED





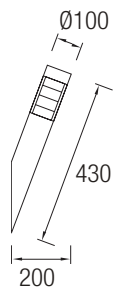

PRIAP NEW

05-9239-CA-M2 ■

E-27 max. 23W / max. L=152mm Ø=50mm
Fluorescent - LED

IP 54
 INOX AISI 316
 PC TRAN DIF
 4

P. 713

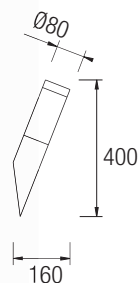
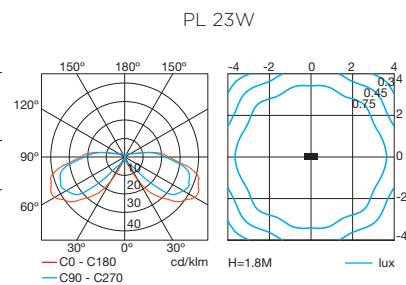

ELECTRA

05-8790-Y4-M1 ■

E-27 max. 23W / max. L=167mm Ø=55mm
Fluorescent - LED

IP 55
 INOX AISI 202
 PC OPAL DIF
 6

P. 717



55-8791-Y4-Y4 ■

Kit reflector. / Reflector kit. / Kit réflecteur. / Reflektor-Kit. / Kit rifletto-
re. / Kit reflektor. / Комплект отражателей. / Zestaw odbłyśnika.

12

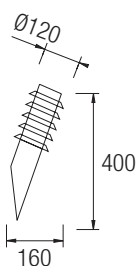

ELECTRA

05-9333-J6-M1 ■

E-27 max. 23W / max. L=167mm Ø=51mm
Fluorescent - LED

IP 55
 INOX AISI 202
 PC OPAL DIF
 4

P. 717







EDWARDS

05-9613-CA-B8 ■

E-27 max. 75W / max. L=160mm Ø=50mm
Halogen - Fluorescent - LED



IP 44



GLA MAT DIF



P.715

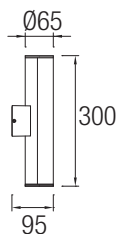
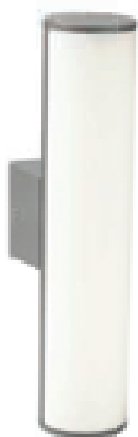

MONACO NEW

05-9780-34-M1 ■

40 LED 100-240V 8W 600lm⁽ⁿ⁾
Warm white 3000K



IP 54



PC OPAL DIF

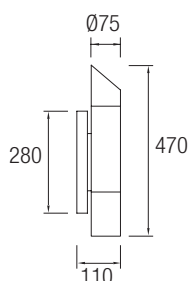
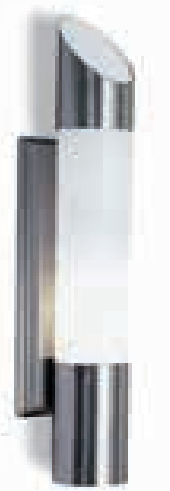

NEREO

05-8796-Y4-M1 ■

E-27 max. 20W / max. L=167mm Ø=51mm
Fluorescent - LED



IP 44

RF 850°C



PC OPAL DIF







AJAX

05-9600-CA-B8 ■

E-27 max. 40W / max. L=80mm Ø=55mm
Halogen - Fluorescent - LED

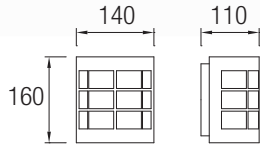

TREBBIN NEW

05-9777-CA-G5 ■

12 LED SAMSUNG 110-230V 4,2W 540lm^(N)
Warm white 3000K

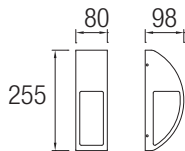
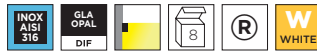

AJAX

05-9207-J6-M1 ■

05-9207-Y4-M1 ■

E-27 max. 60W / max. L=140mm Ø=70mm
Halogen - Fluorescent - LED

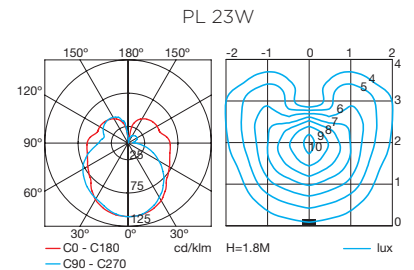
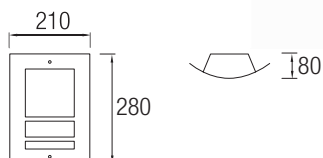



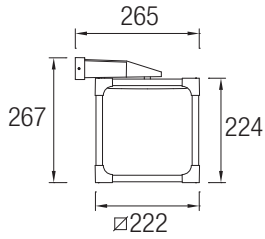

VINTAGE NEW

05-9774-CC-M1 ■

192 LED 100-240V 13W 1344lm^(ND)
Warm white 3000K



EAGLE RISE

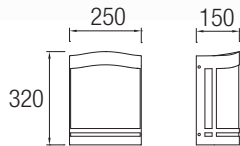

SOPHIE

05-9509-Z5-37 ■

E-27 max. 23W / max. L=165mm Ø=50mm
Fluorescent - LED

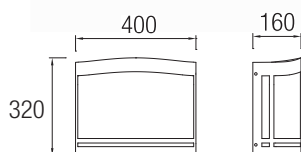

SOPHIE

05-9510-Z5-37 ■

2 x E-27 max. 23W / max. L=165mm Ø=50mm
Fluorescent - LED

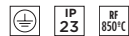



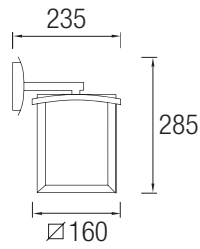

MARK

05-9298-14-M1

PC OPAL **NEW**

05-9298-Z5-M3

PC MAT

E-27 max. 100W / max. L=150mm
Halogen - Fluorescent - LED



IP 23



AL PUR



PC MAT



IP+



DIF



6



®



P. 609



P. 607



P. 679



P. 709

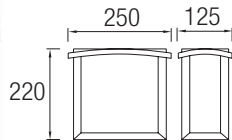
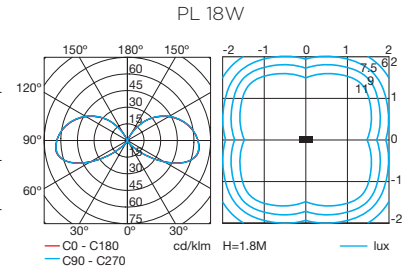

MARK

05-9299-Z5-M3

■

2 x E-27 max. 60W / max. L=150mm Ø=50mm
Halogen - Fluorescent - LED



IP 23



AL PUR



PC MAT



IP+



DIF



6



®



P. 609



P. 607



P. 679



P. 709

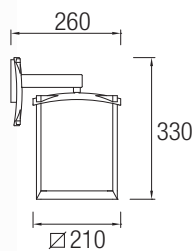
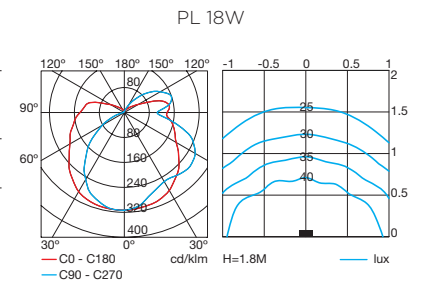

MARK

05-9390-Z5-M3

■

E-27 max. 100W / max. L=200mm
Halogen - Fluorescent - LED



IP 23



AL PUR



PC MAT



IP+



4



®



P. 609



P. 607



P. 679



P. 709

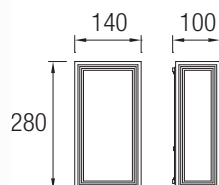
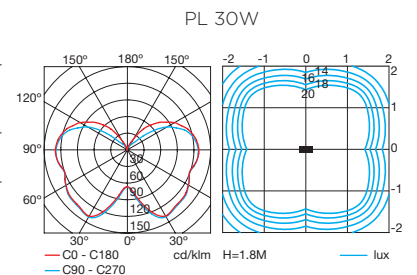

THOMAS

05-9686-Z5-M1

■

E-27 max. 23W / max. L=180mm
Fluorescent - LED



IP 44



AL INJ



PC OPAL



DIF



8



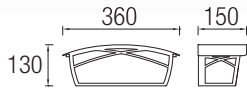

ALBA

05-9351-18-AA

E-27 max. 100W / max. Ø=60mm
Halogen - Fluorescent - LED



2 juegos de cristales incluidos (rústico ámbar + transparente satinado). / 2 sets of glasses included (rustic amber + transparent satin). / 2 jeux de verres fournis (rustique ambré + transparent satiné). / 2 Scheibensätze eingeschl. (rustikal bernsteinfarben + transparent satiniert). / 2 set di vetri inclusi (rustico ambrà + trasparente satinato). / 2 jogos de vidros incluídos (rústico âmbar + transparente acetinado). / 2 стекла включены в комплект (янтарное и прозрачное сатинованное). / Zawarte 2 komplety szkła (rustykalny bursztynowy + satynowany przezroczysty)

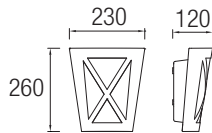

AJAX

05-9373-J6-M3

E-27 max. 60W / max. L=140mm Ø=70mm
Halogen - Fluorescent - LED

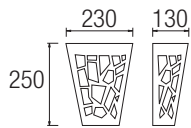
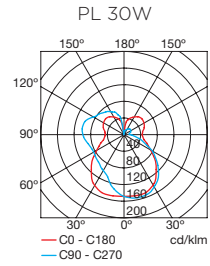

AJAX

05-9718-J6-M3

E-27 max. 60W / max. L=140mm Ø=70mm
Halogen - Fluorescent - LED

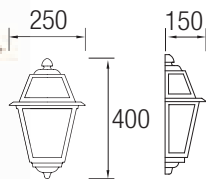

OCEANO

05-9158-18-AA

E-27 max. 100W / max. L=167mm Ø=51mm
Halogen - Fluorescent - LED

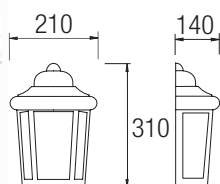

PERSEO

05-8762-18-37

E-27 max. 100W / max. L=152mm Ø=50mm
Halogen - Fluorescent - LED





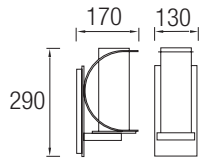

CIRI

05-9330-05-B8 ■

E-27 max. 100W / max. L=155mm
Halogen - Fluorescent - LED

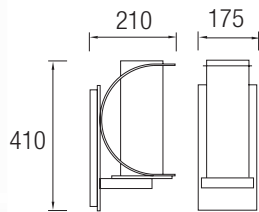
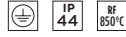

CIRI

05-9331-05-B8 ■

E-27 max. 100W / max. L=170mm
Halogen - Fluorescent - LED

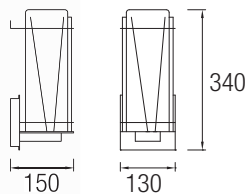
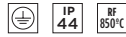

REED

05-9356-05-B8 ■

E-27 max. 100W / max. L=165mm
Halogen - Fluorescent - LED





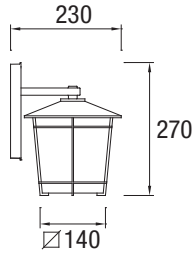

JANNA

05-9447-18-M3 ■

E-27 max. 100W / max. L=165mm
Halogen - Fluorescent - LED

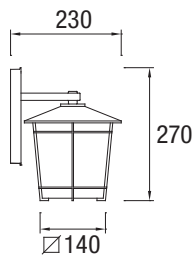
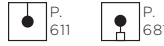

JANNA

05-9522-18-M3 ■ (S)

6 LED 100-240V 4W 376lm^(N)
Warm white 3000K

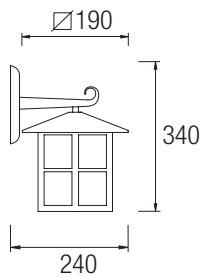

ODISEO

05-9126-18-AA ■

E-27 max. 100W / max. L=152mm Ø=50mm
Halogen - Fluorescent - LED



CRIS +

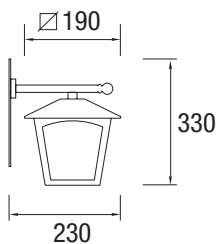

EDIPO

05-9149-18-AA ■

E-27 max. 100W / max. L=140mm Ø=51mm
Halogen - Fluorescent - LED



CRIS +





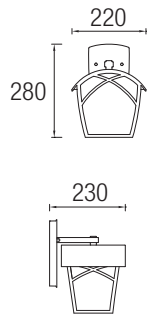

ALBA

05-9350-18-AA

E-27 max. 100W / max. L=165mm
Halogen - Fluorescent - LED



IP 23

Bf 850°C



IP+



P. 611



P. 607



P. 681



P. 719



2 juegos de cristales incluidos (rústico ámbar + transparente satinado). / 2 sets of glasses included (rustic amber + transparent satin). / 2 jeux de verres fournis (rustique ambré + transparent satiné). / 2 Scheibensätze eingeschl. (rustikal bersteinfarben + transparent satiniert). / 2 set di vetri inclusi (rustico ambrà + trasparente satinato). / 2 jogos de vidros incluídos (rústico ámbar + transparente acetinado). / 2 стекла включены в комплект (янтарное и прозрачное сатинованное). / Zawarte 2 komplety szkła (rustykalny bursztynowy + satynowany przezroczysty)

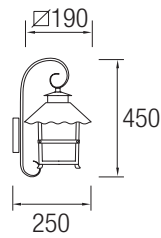

PERSEFONE

05-9202-18-AA

E-27 max. 100W / max. L=167mm Ø=51mm
Halogen - Fluorescent - LED



IP 23

CRIS +



IP+

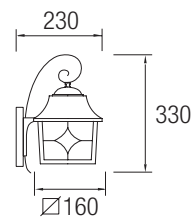

HERA

05-9124-18-37

E-27 max. 100W / max. L=117mm Ø=45mm
Halogen - Fluorescent - LED



IP 23

Bf 850°C

CRIS +



IP+





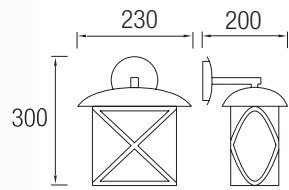

CROSS

05-9295-18-M3

E-27 max. 100W / max. L=180mm
Halogen - Fluorescent - LED

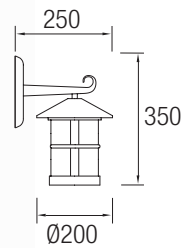

ITACA

05-9132-18-AA

E-27 max. 100W / max. L=167mm Ø=51mm
Halogen - Fluorescent - LED

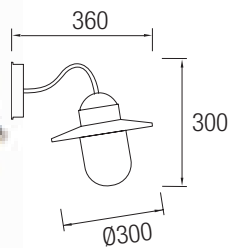

TRITON

05-8959-05-37

E-27 max. 100W / max. L=152 mm Ø=50mm
Halogen - Fluorescent - LED

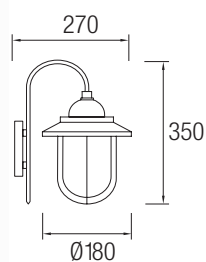

SIRENA

05-9104-18-M2

E-27 max. 60W / max. L=140mm Ø=51mm
Halogen - Fluorescent - LED





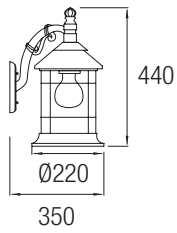

ANDREA NEW

05-9785-18-AA

E-27 max. 100W / max. L=180mm
Halogen - Fluorescent - LED

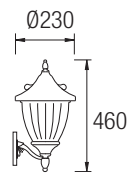

GALATEA

05-9151-18-E7

E-27 max. 100W / max. L=167mm
Halogen - Fluorescent - LED

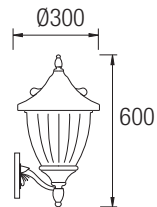

GALATEA

05-9152-18-E7

3 x E-14 max. 60W / max. L=120mm Ø=35mm
Halogen - Fluorescent - LED

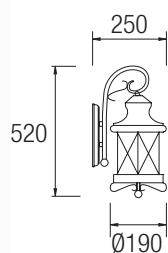

MORFEO

05-9175-18-AA

3 x E-14 max. 60W / max. L=120mm Ø=35mm
Halogen - Fluorescent - LED





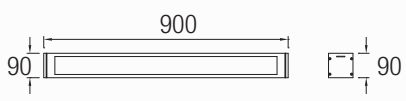

AFRODITA

15-9560-34-37

T5 39W Fluorescent 230V

BAG

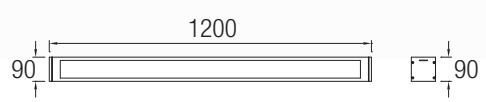
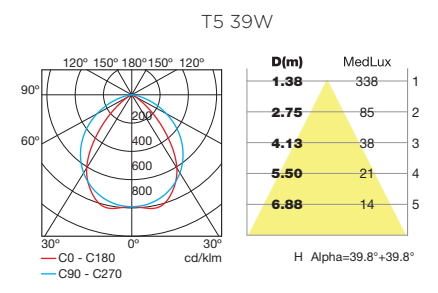

AFRODITA

15-9561-34-37

T5 54W Fluorescent 230V

BAG

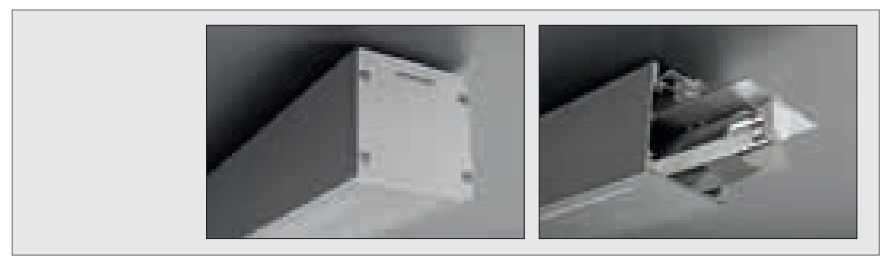
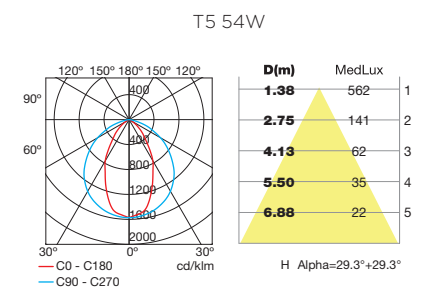

OUTDOOR | CEILING



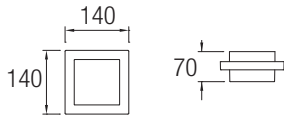

JEP

15-9688-34-M1 ■

25 LED 110-230V 3,5W 370lm^(N)
Warm white 3000K

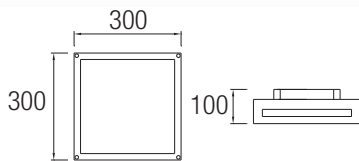
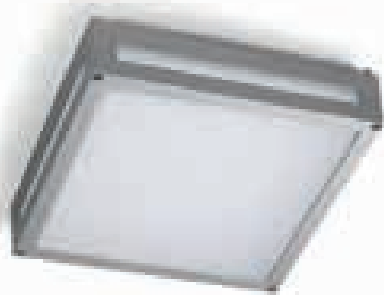

LEGGETT

15-9696-34-CD ■ 3000K 1180lm^(N)

15-9540-34-M3 ■ 4000K 1340lm^(N)

81 LED 220-240V 15W

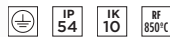

LED 15W

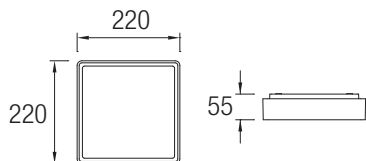
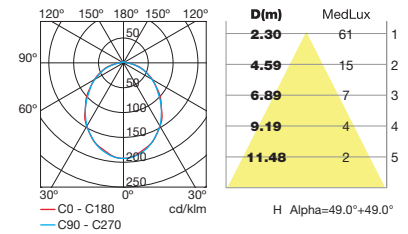

KÖSSEL NEW

15-9778-34-CD ■

100 LED 220-240V 6,5W 715lm^(N)
Warm white 3000K

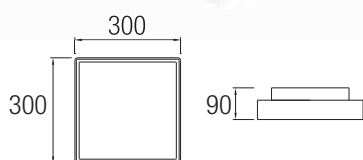

KÖSSEL

15-9619-34-M1 ■

2 x E-27 max.18W / max. L=160mm Ø=50mm
Fluorescent - LED





103

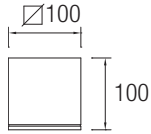

AFRODITA

15-9680-34-37 ■

4 LED CREE 100-240V 9W 828lm⁽ⁿ⁾
Neutral white 4000K

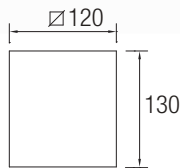

AFRODITA

15-9558-CA-B8 ■■

Par-20/30 E-27 max. 50W /
max. L=98mm Ø=97mm
Halogen - Fluorescent - LED



Par-30 50W

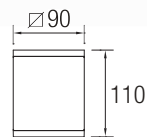
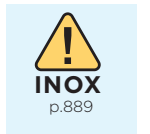
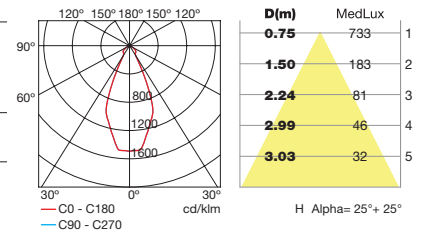

AFRODITA

15-9480-34-37 ■

15-9480-Z5-37 ■

GU-10 max. 35W / max. L=75mm
Halogen - Fluorescent - LED



GU-10 35W

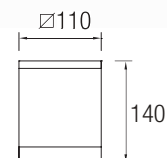
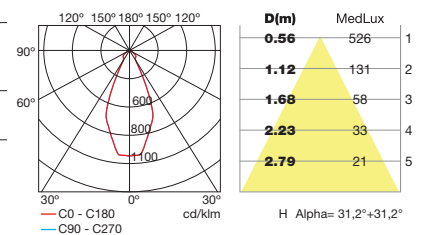

AFRODITA

15-9328-34-B8 ■

15-9328-Z5-B8 ■

Par-30 E-27 max. 75W / max. L=90mm Ø=97mm
Halogen - Fluorescent - LED



Par-30 75W

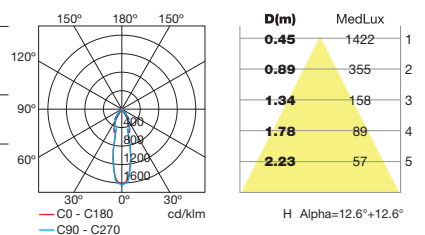



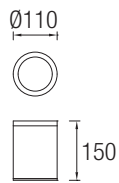

COSMOS

15-9362-34-37

15-9362-Z5-37

Par-30 E-27 max. 75W / max. L=90mm Ø=97mm
Halogen - Fluorescent - LED

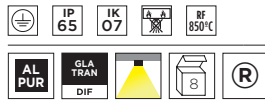

Par-30 75W

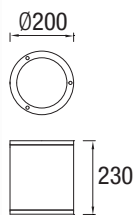
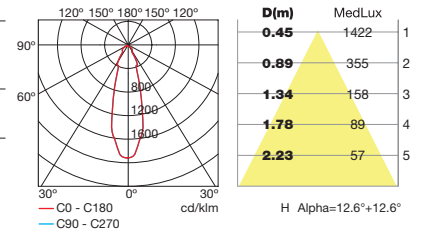

COSMOS

15-9363-34-37

15-9363-Z5-37

PAR-38 E-27 max. 80W / max. L=180mm
Halogen - Fluorescent - LED



PAR-38 80W

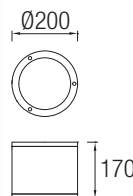
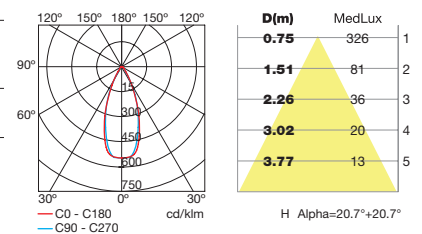

COSMOS

15-9365-34-T2

15-9365-Z5-T2

2 x GX24d-3 26W Fluorescent 230V

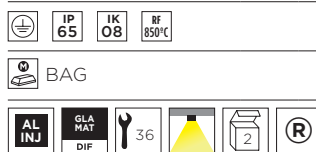

2 x GX24d-3 26W

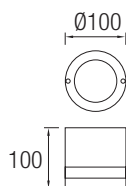
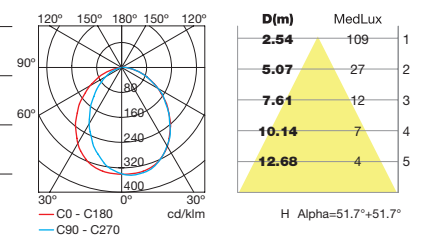

SELENE

15-9234-34-37

GU-10 max. 50W / max. L=70mm
Halogen - Fluorescent - LED

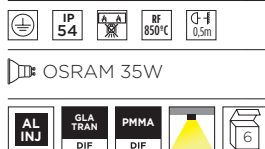

GU-10 50W

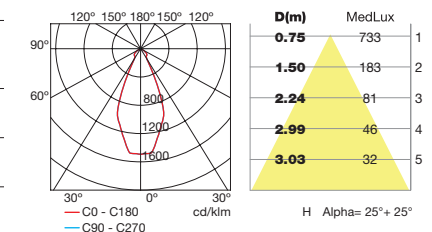

Difusor de PMMA azul de cortesia. / Blue courtesy PMMA diffuser.
/ Diffuseur bleu en PMMA. / Blauer PMMA-Difusor inklusive. /
Diffusore in PMMA azzurro di cortesia. / Difusor de PMMA azul de
oferta. / Голубой рассеиватель из PMMA в подарок. / Niebieski
dyfuzor pomocniczy PMMA.





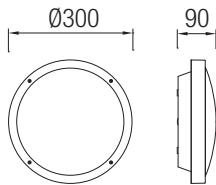

OPAL

15-9677-14-M1

2 x E-27 max. 23W / max. L=165mm Ø=55mm
Fluorescent - LED



Base translúcida para recrear un efecto de luz decorativo en la superficie.
Traslucent base to create a decorative light effect on the surface.
Socle translucide pour recréer un effet de lumière décoratif en surface.
Durchscheinende Rückseite zur Schaffung von dekorativen Lichteffekten.
Base traslúcida per ricreare un effetto di luce decorativo in superficie.
Base translúcida para recriar um efeito de luz decorativo na superfície.
Полупрозрачная основа для создания декоративного светового эффекта на поверхности.
Półprzezroczysta podstawa dla wytworzenia efektu światła dekoracyjnego na powierzchni.



LED KIT

71-9711-00-00 Neutral white 4000K 1400lm⁽ⁿ⁾

71-9712-00-00 Warm white 3000K 1350lm⁽ⁿ⁾

36 LED 100-240V 13W



Kit LED para / LED kit for / Kit LED pour / LED-Kit für / Kit LED per / Kit LED para / Комплект СД для / Zestaw LED dla / **15-9677**

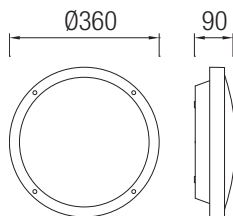

OPAL

15-9678-14-M1

2 x E-27 max. 30W / max. L=180mm Ø=55mm
Halogen - Fluorescent - LED



SENSOR DE MICROONDAS.
MICROWAVE SENSOR
CAPTEUR À MICRO-ONDES
MIKROWELLENSENSOR.
SENSORE DI MICROONDE.
SENSOR DE MICRO-ONDAS. МИКРОВОЛНОВЫЙ ДАТЧИК
CZUJNIK MIKROFAL.

Base translúcida para recrear un efecto de luz decorativo en la superficie.
Traslucent base to create a decorative light effect on the surface.
Socle translucide pour recréer un effet de lumière décoratif en surface.
Durchscheinende Rückseite zur Schaffung von dekorativen Lichteffekten.
Base traslúcida per ricreare un effetto di luce decorativo in superficie.
Base translúcida para recriar um efeito de luz decorativo na superfície.
Полупрозрачная основа для создания декоративного светового эффекта на поверхности.
Półprzezroczysta podstawa dla wytworzenia efektu światła dekoracyjnego na powierzchni.





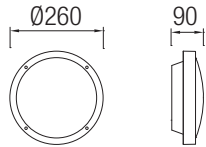

BASIC

15-9491-34-M3

E-27 max. 18W / max. L=165mm Ø=55mm
Fluorescent - LED

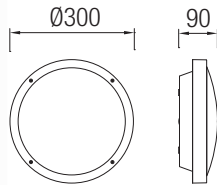

BASIC

15-9493-34-M3

2 x E-27 max. 23W / max. L=165mm Ø=55mm
Fluorescent - LED

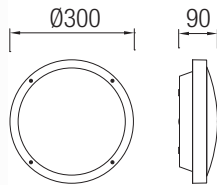

BASIC

15-9676-34-M3

2 x G24q-2 18W Fluorescent 230V



BAG

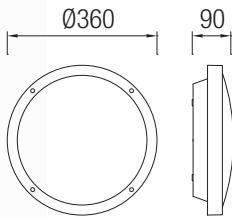

BASIC

15-9542-34-M3

2 x E-27 max. 23W / max. L=180mm
Fluorescent - LED



LED KIT

71-9711-00-00 Neutral white 4000K 1400lm⁽ⁿ⁾

71-9712-00-00 Warm white 3000K 1350lm⁽ⁿ⁾

36 LED 100-240V 13W



Kit LED para / LED kit for / Kit LED pour / LED-Kit für / Kit LED per / Kit LED para / Комплект СД для / Zestaw LED dla / **15-9491, 15-9493, 15-9542**



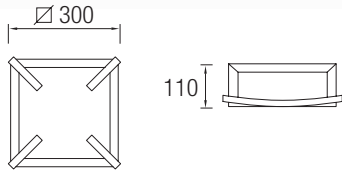

MARK

15-9298-Z5-M3 ■

2 x E-27 max. 100W /
max. L= 167mm Ø=50mm
Halogen - Fluorescent - LED

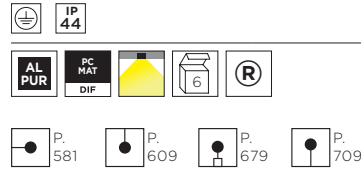

PL 23W

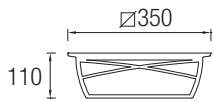
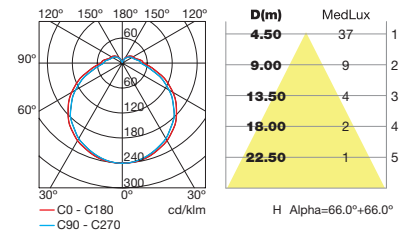

ALBA

15-9350-18-AA ■

2 x E-27 max. 100W /
max. L=200mm Ø=52mm
Halogen - Fluorescent - LED

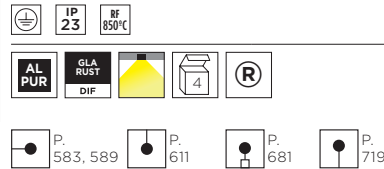

2 juegos de cristales incluidos (rústico ámbar + transparente satinado), / 2 sets of glasses included (rustic amber + transparent satin) / 2 jeux de verres fournis (rustique ambré + transparent satiné), / 2 Scheibensätze eingeschl. (rustikal bernsteinfarben + transparent satiniert) / 2 set di vetri inclusi (rustico ambrá + trasparente satinato), / 2 jogos de vidros incluidos (rústico ámbar + transparente acetinado), / 2 стекла включены в комплект (янтарное и прозрачное сатинованное). / Zawarte 2 komplety szkła (rustykalny bursztynowy + satynowany przezroczysty)

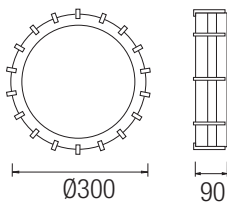

SIMS

15-9717-34-M1 ■

2 x E-27 max. 23W / max. L=200mm Ø=51mm
Fluorescent - LED

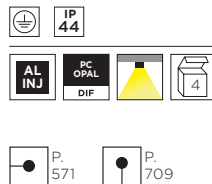

ECLIPSE

15-9300-34-M3 ■

2 x G24d-3 26W Fluorescent 230V

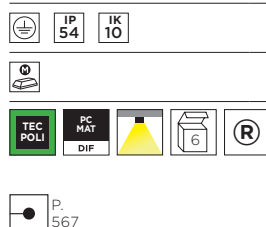

2 x G24d-3 26W

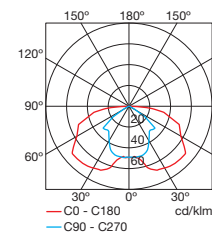





KAP

00-9669-14-M1

4 x E-27 max. 13W / max. L=120mm Ø50mm
Fluorescent - LED

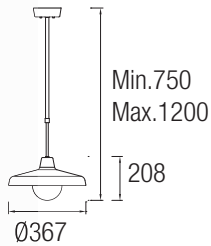
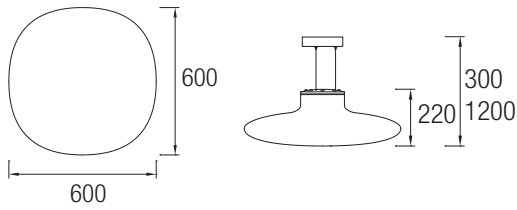

JAMBO NEW

00-9742-Z5-M1

E-27 max. 18W / max. L=120mm Ø=50mm
Fluorescent - LED

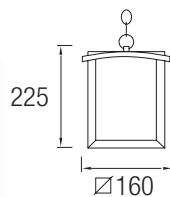
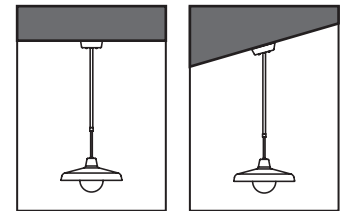

MARK

00-9298-14-M1 PC OPAL NEW

00-9298-Z5-M3 PC MAT

E-27 max. 100W / max. L=150mm
Halogen - Fluorescent - LED

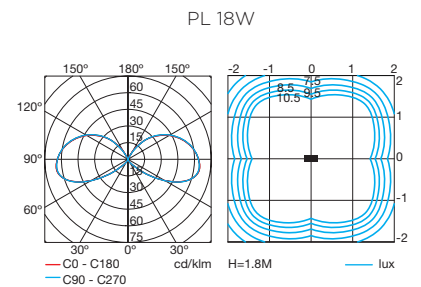
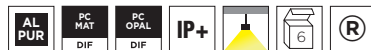



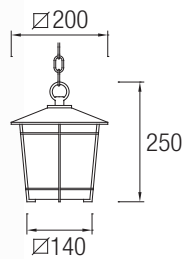

JANNA

00-9522-18-M3 ■ (S)

6 LED 100-240V 4W 376lm⁽ⁿ⁾
Warm white 3000K

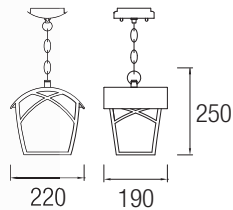
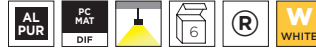

ALBA

00-9350-18-AA ■

E-27 max. 100W / max. L=165mm
Halogen - Fluorescent - LED

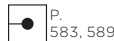

2 juegos de cristales incluidos (rústico ámbar + transparente satinado). / 2 sets of glasses included (rustic amber + transparent satin). / 2 jeux de verres fournis (rustique ambré + transparent satiné). / 2 Scheibensätze eingesch. (rustikal bersteinfarben + transparent satiniert). / 2 set di vetri inclusi (rustico ambr + trasparente satinato). / 2 jogos de vidros incluidos (rústico ámbar + transparente acetinado). / 2 стекла включены в комплект (янтарное и прозрачное сатинированное). / Zawarte 2 komplety szkła (rustykalny bursztynowy + satynowany przezroczysty)

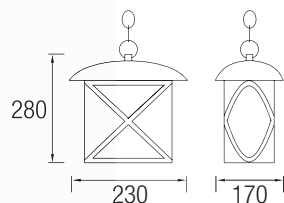

CROSS

00-9295-18-M3 ■

E-27 max. 100W / max. L=180mm
Halogen - Fluorescent - LED







ANDREA NEW

00-9785-18-AA ■

E-27 max. 100W / max. L=180mm
Halogen - Fluorescent - LED

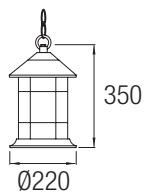

GALATEA

00-9151-18-E7 ■

E-27 max. 100W / max. L=167mm Ø=51mm
Halogen - Fluorescent - LED

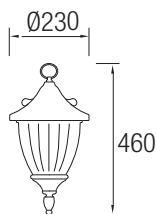
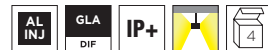
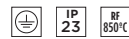



BARCELÓ HOTEL, SANTO DOMINGO.



GEA

15-9562-34-37

T5 39W Fluorescent 230V

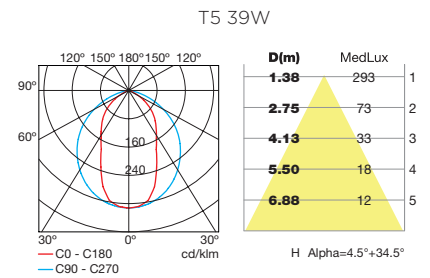
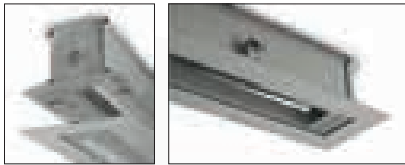
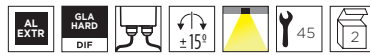
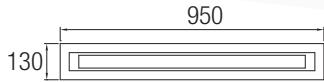

GEA

15-9563-34-37

T5 54W Fluorescent 230V

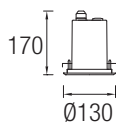
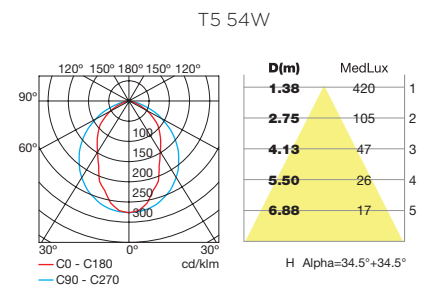
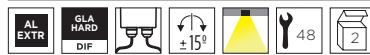
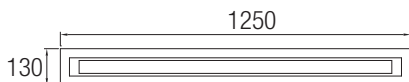

GEA

15-9708-Y4-37

GU-10 / MR-16 max. 50W / L=65mm
Halogen - Fluorescent - LED



Incluye 2 portalámparas: GU10 y GU5.3 (MR16). / Includes 2 lampholders: GU10 and GU5.3 (MR16). / 2 douilles fournies: GU10 et GU5.3 (MR16). / Einschließlich 2 Fassungen: GU10 und GU5.3 (MR16). / Comprende 2 portalampade: GU10 e GU5.3 (MR16). / Inclui 2 suportes de casquilho: GU10 e GU5.3 (MR16). / В набор включены 2 патрона: GU10 и GU5.3 (MR16). / Zawiera 2 oprawki: GU10 i GU5.3 (MR16).

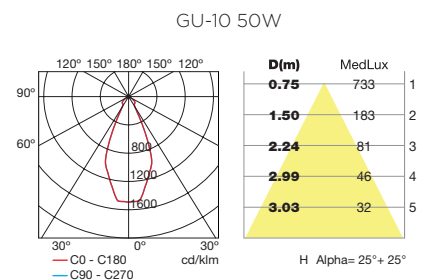

71-9448-CA-CA

Aro de acero inoxidable AISI 316 para / AISI 316 Stainless steel ring for / Anneau en acier inoxydable AISI 316 pour / Ring aus Edelstahl AISI 316 für / Anello d'acciaio inossidabile AISI 316 per / Aro de aço inoxidável AISI 316 para / Кольцо из нержавеющей стали AISI 316 для / Obręcz ze stali nierdzewnej AISI 316 dla

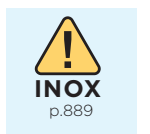



McDONALD'S SABADELL, SPAIN.

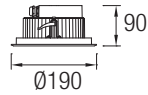

GEA

15-9665-CA-37

9 LED PHILIPS 230V 18W 1845lm^(N)
Neutral white 4200K



EAGLE RISE

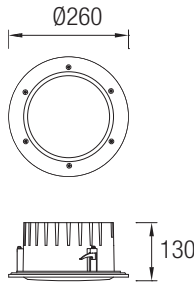
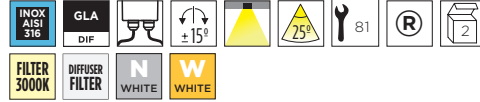

GEA

15-9659-M3-CD

2 x GX24d-3 26W 230V

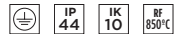

BAG



2 x GX24d-3 26W

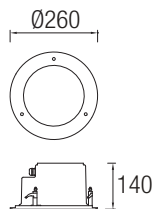
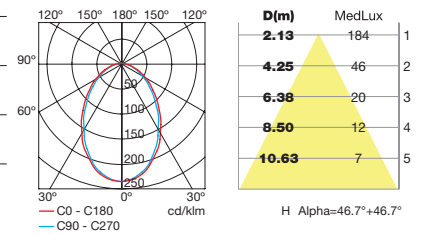

GEA

15-9391-Y4-B8

GX24d-3 26W 230V



BAG



GX24d-3 26W

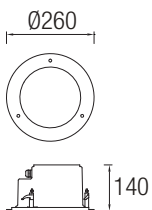
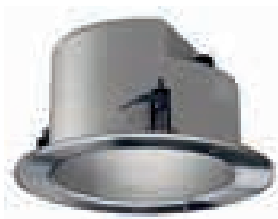
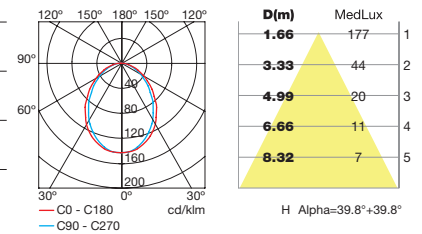

GEA

15-9392-Y4-B8

2 x GX24d-3 26W 230V



BAG



2 x GX24d-3 26W

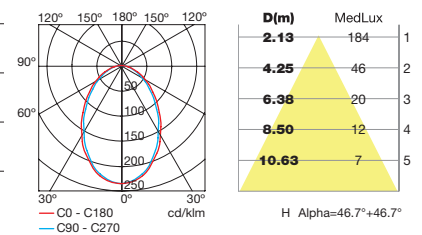

Caja para empotrar en techo de hormigón: página 880
 Built-in concrete ceiling box: page 880
 Boîtier à encastrer dans un plafond en béton: page 880
 Gehäuse zum Einbau in Betondecke: Seite 880
 Scatola per incasso a soffitto in cemento: pagina 880
 Caixa para encastrar em tetos de betão: página 880
 Встраиваемая в цементный потолок коробка 880
 Skrzynka do wbudowania w betonowy sufit: strona 880





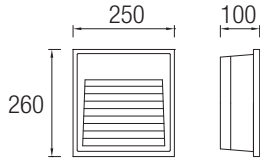

MICENAS

05-9434-34-T2 ■

G24d-3 26W Fluorescent 230V

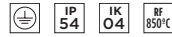

BAG



G24 d-3 26W

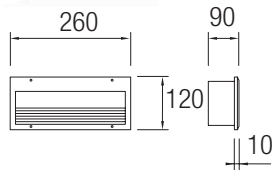
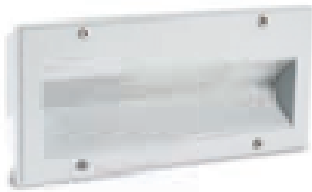
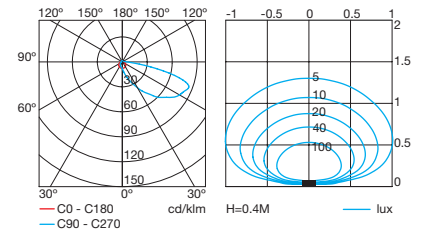

MICENAS

05-9179-14-B8 □

05-9179-34-B8 ■

05-9179-Z5-B8 ■

G24d-3 26W Fluorescent 230V



BAG / VOSSLOH



G24d-3 26W

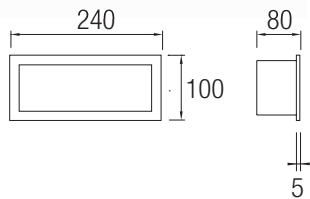
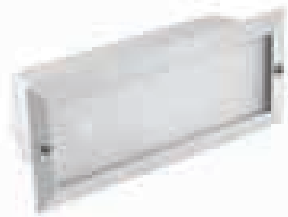
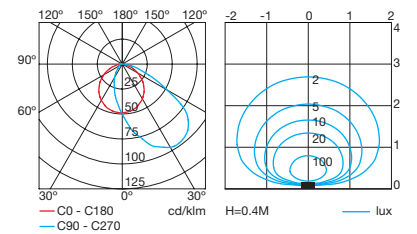

HERCULES

05-8961-05-B8 ■

05-8961-14-B8 □

05-8961-34-B8 ■

E-27 max. 60W / max. L=145mm Ø=45mm
Halogen - Fluorescent - LED



PL 20W

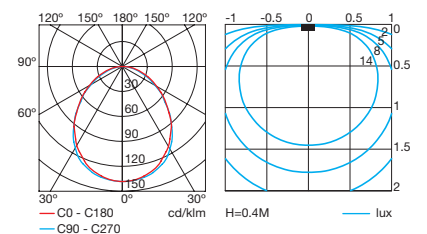

71-8969-00-00

Reactancia para / Ballast for / Ballast pour /
Vorschaltgerät für / Reattanza per / Reaktância
para / Реактивное сопротивление для /
Reaktancja dla **05-8961**

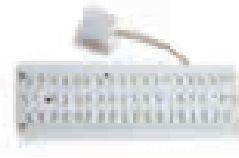

LED KIT

71-9713-00-00 Neutral white 4000K 432lm⁽⁰⁾

71-9714-00-00 Warm white 3000K 382lm⁽⁰⁾

54 LED 100-240V 3,5W



Kit LED para / LED kit for / Kit LED pour / LED-Kit für / Kit LED per /
Kit LED para / Комплект СД для / Zestaw LED dla **05-8961**

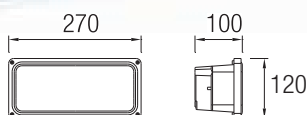

BASIC

05-9589-Z5-T2 ■ (S)

G24d-3 26W Fluorescent 230V



BAG



G24d-3 26W

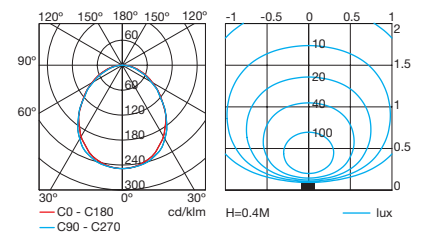



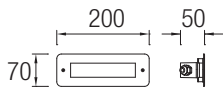

GEA

05-9653-CA-M2

10 LED 110-230V 1W 107lm^(N)
Neutral white 4000K



Difusor prismatizado para evitar deslumbramiento.
Prismatic diffuser to prevent glare.
Diffuseur prismatisé anti-éblouissement.
Prismatisierter Diffusor als Blendschutz.
Diffusore prismatizzato per evitare abbagliamento.
Difusor prismático para evitar o encandeamiento.
Призматический рассеиватель для избежания ослепления.
Przyrmaticzny dyfuzor dla uniknięcia oślenia.

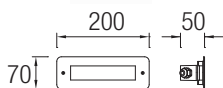

GEA

05-9654-CA-M2

3 LED CREE 100-240V 3W 366lm^(N)
Neutral white 4000K

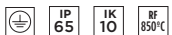

EAGLE RISE

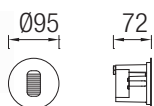

MICENAS

05-9757-Y4-37

LED CREE 100-240V 2,2W 207lm^(N)
Warm white 3000K

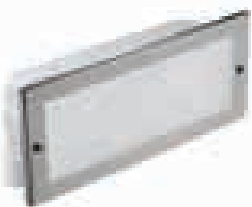
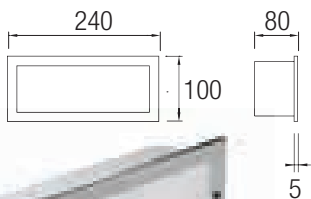

HERCULES

05-9211-CA-T2 INOX AISI 316
05-9211-Y4-T2 INOX AISI 202

E-27 max. 60W / max. L=145mm Ø=45mm
Halogen - Fluorescent - LED

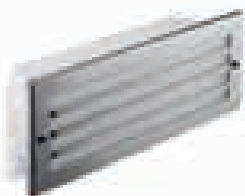
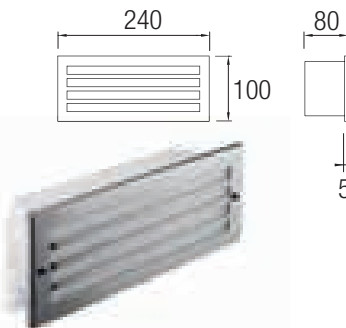
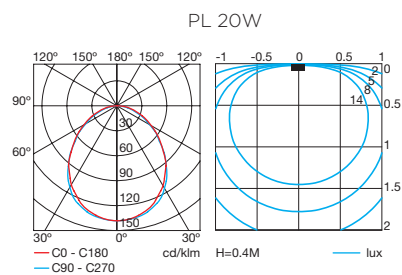
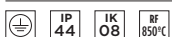

HERCULES

05-9212-CA-T2 INOX AISI 316
05-9212-Y4-T2 INOX AISI 202

E-27 max. 60W / max. L=145mm Ø=45mm
Halogen - Fluorescent - LED

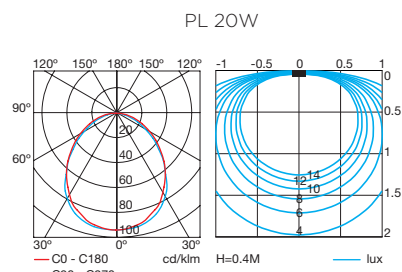
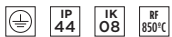

71-8969-00-00

Reactancia para / Ballast for / Ballast pour / Vorschaltgerät für / Reattanza per / Reactància para / Реактивное сопротивление для / Reaktancja dla
05-9211 / 05-9212



LED KIT

71-9713-00-00 Neutral white 4000K 432lm^(N)

71-9714-00-00 Warm white 3000K 382lm^(N)

54 LED 100-240V 3,5W

EAGLE RISE



Kit LED para / LED kit for / Kit LED pour / LED-Kit für / Kit LED per / Kit LED para / Комплект СД для / Zestaw LED dla 05-9211 / 05-9212



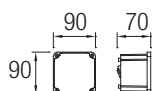

BASIC

05-9583-05-M3 ■

GX53 max. 9W
Fluorescent - LED



LED 1,5W

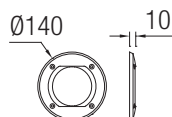
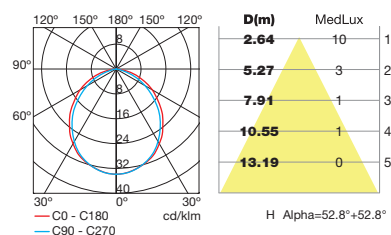

BASIC

71-9583-Z5-Z5 ■

Accesorio para / Accessory for / Accessoire pour / Zubehör für / Accessorio per / Acessório para / Принадлежность для / Akcesorium do **05-9583**

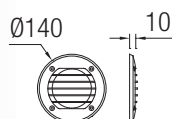

BASIC

71-9584-Z5-Z5 ■

Accesorio para / Accessory for / Accessoire pour / Zubehör für / Accessorio per / Acessório para / Принадлежность для / Akcesorium do **05-9583**

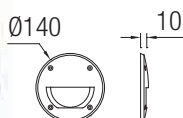

BASIC

71-9585-Z5-Z5 ■

Accesorio para / Accessory for / Accessoire pour / Zubehör für / Accessorio per / Acessório para / Принадлежность для / Akcesorium do **05-9583**

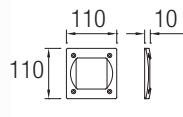

BASIC

71-9586-Z5-Z5 ■

Accesorio para / Accessory for / Accessoire pour / Zubehör für / Accessorio per / Acessório para / Принадлежность для / Akcesorium do **05-9583**

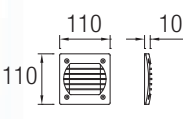

BASIC

71-9587-Z5-Z5 ■

Accesorio para / Accessory for / Accessoire pour / Zubehör für / Accessorio per / Acessório para / Принадлежность для / Akcesorium do **05-9583**

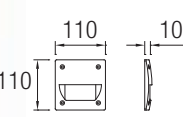

BASIC

71-9588-Z5-Z5 ■

Accesorio para / Accessory for / Accessoire pour / Zubehör für / Accessorio per / Acessório para / Принадлежность для / Akcesorium do **05-9583**

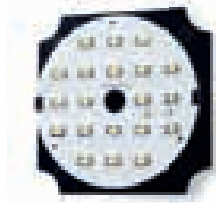

LED KIT

71-9709-00-00 Neutral white 4000K 160lm^(N)

71-9710-00-00 Warm white 3000K 142lm^(N)

20 LED 100-240V 1,5W



Kit LED para / LED kit for / Kit LED pour / LED-Kit für / Kit LED per / Kit LED para / Комплект СД для / Zestaw LED dla **05-9583**



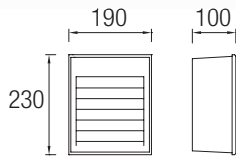

MICENAS NEW

05-9772-34-M2

27 LED 220-240V 3W 297lm^(N)
Neutral white 4000K



LED 3W

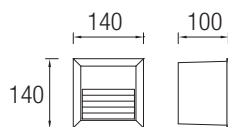
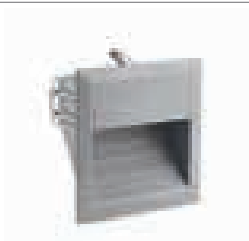
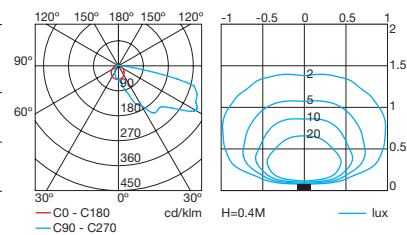

MICENAS NEW

05-9770-34-M2

18 LED 220-240V 2W 198lm^(N)
Neutral white 4000K



LED 2W

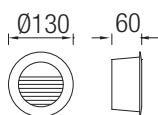
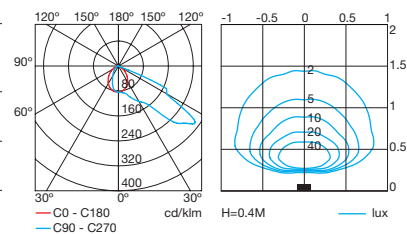

MICENAS NEW

05-9771-34-M2

14 LED 220-240V 1,5W 154lm^(N)
Neutral white 4000K



LED 1,5W

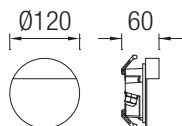
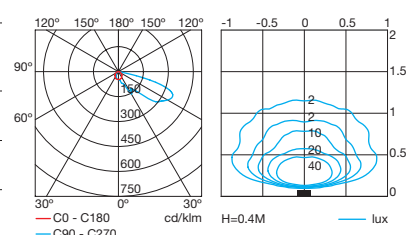

MICENAS

05-9705-34-37

LED CREE 100-240V 2,2W 207lm^(N)
Neutral white 4000K





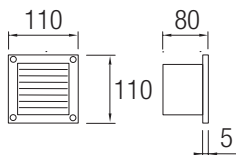
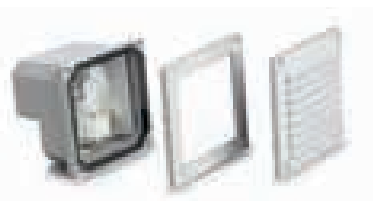

MICENAS

05-9182-34-B8 ■

G9 max. 40W



40W



G9 40W

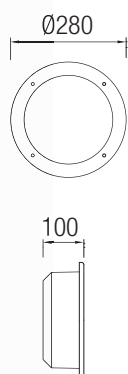
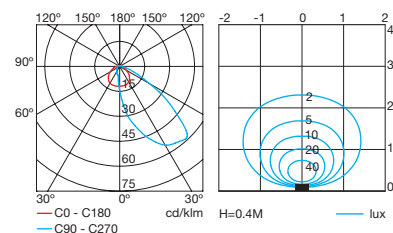

DALTON

05-9467-34-B8 ■ (S)

2 x G24d-2 18W Fluorescent 230V



2 x G24d-2 18W

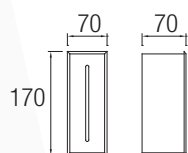
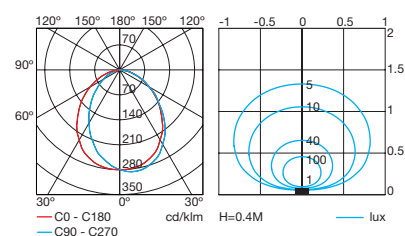

MICENAS

05-9596-34-37 ■

LED CREE 100-240V 2,2W 207lm^(N)
Neutral white 4000K



LED 3W

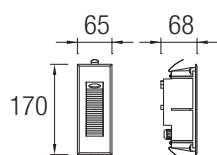
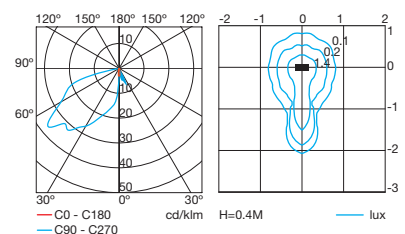

MICENAS NEW

05-9758-34-37 ■

LED CREE 100-240V 2,2W 182lm^(N)
Warm white 3000K



OUTDOOR | RECESSED



CROWNE PLAZA HOTEL. LIÈGE, BELGIUM.

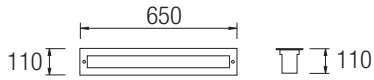

GEA
55-9264-Y4-37

T5 24W Fluorescent 230V <40°C



BAG

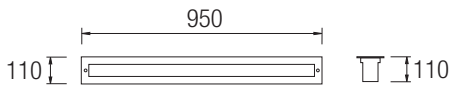
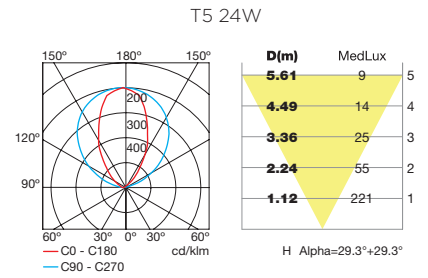
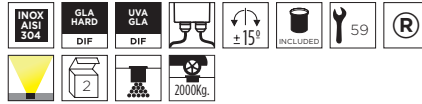

GEA
55-9265-Y4-37

T5 39W Fluorescent 230V <40°C

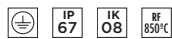

BAG

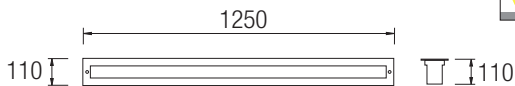
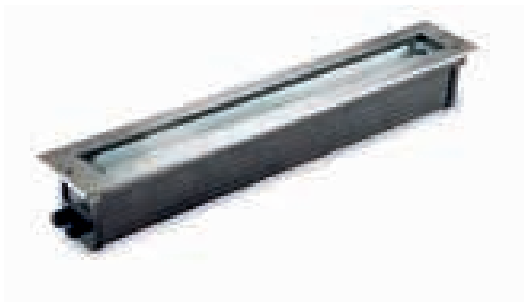
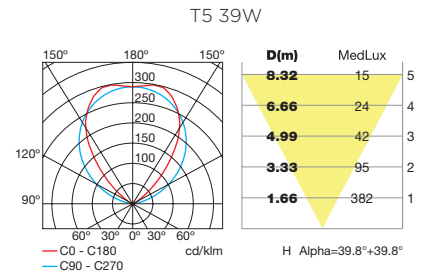
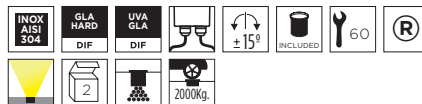

GEA
55-9266-Y4-37

T5 54W Fluorescent 230V <40°C



BAG

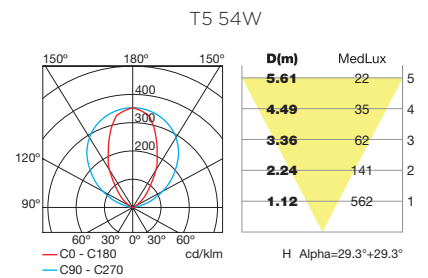
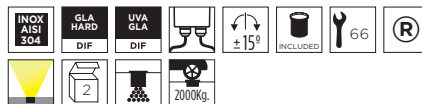

OUTDOOR | RECESSED

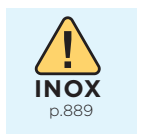





GEA

55-9523-Y4-37

12 LED PHILIPS 100-240V 12W 1368lm^(N)
Neutral white 4000K <40°C



MEANWELL

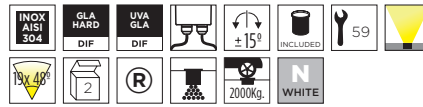

LED 12W

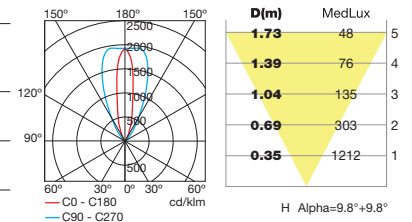

GEA

55-9527-Y4-37

24 LED PHILIPS 100-240V 24W 2736lm^(N)
Neutral white 4000K <40°C



MEANWELL



LED 24W

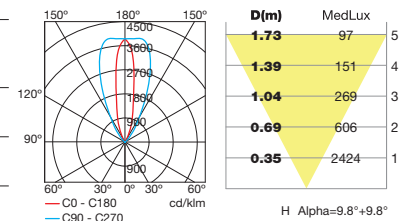

GEA

55-9524-Y4-37

12 LED PHILIPS 100-240V 12W
RGB <40°C



MEANWELL + DMX controller



LED 12W Verde / Green

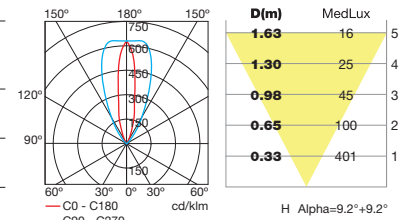

GEA

55-9528-Y4-37

24 LED PHILIPS 100-240V 24W
RGB <40°C



MEANWELL + DMX controller

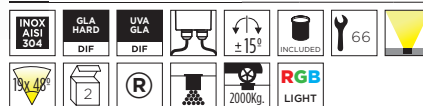

LED 24W Verde / Green

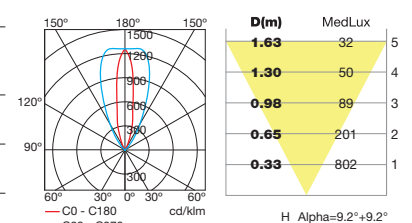

Para versión en blanco DMX dimable CONSULTAR
Please consult your sales representative for white DMX dimmable version
Veuillez nous consulter pour la version en blanc DMX dimmable (à variateur)
Ausführung in weiß DMX mit dimmbar AUF ANFRAGE
Per la versione in bianco DMX dimmerabile sollecitare informazioni
Para versão em branco DMX dimerável CONSULTAR
СПРОСИТЕ о наличии версии DMX в белом цвете
Wersja biała DMX na zapytanie

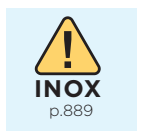



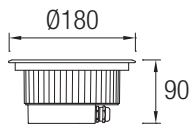

GEA

55-9665-CA-37 ■

9 LED PHILIPS 100-240V 9W 1026lm^(N)
Neutral white 4000K <40°C



EAGLE RISE

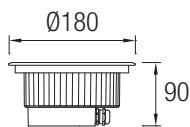

GEA

55-9667-CA-37 ■

9 LED PHILIPS 230V 18W 1845lm^(N)
Neutral white 4000K <40°C

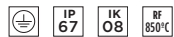

EAGLE RISE

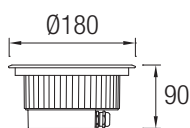

GEA

55-9666-CA-37 ■

9 LED PHILIPS 9W EASY RGB <40°C

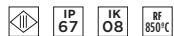

Este aparato sólo funciona con los controladores EASY RGB: /
This fitting only works with EASY RGB controllers: /
Cet appareil ne fonctionne qu'avec les contrôleurs EASY RGB: /
Dieses Gerät funktioiert nur mit den folgenden EASY RGB Controllern: /
Questo dispositivo funziona unicamente con i regolatori EASY RGB: /
Este aparelho só funciona com os controladores EASY RGB: /
Этот аппарат работает только с контроллерами EASY RGB: /
To urządzenie działa tylko z driverami EASY RGB:
71-9630/ 71-9632





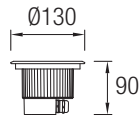

GEA

55-9663-CA-37

3 LED CREE 100-240V 3W 366lm^(N)
Neutral white 4000K



EAGLE RISE

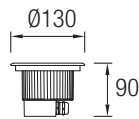

GEA

55-9664-CA-37

3 LED PHILIPS 3W EASY RGB

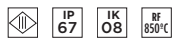

p.877

Este aparato sólo funciona con los controladores EASY RGB: /
This fitting only works with EASY RGB controllers: /
Cet appareil ne fonctionne qu'avec les contrôleurs EASY RGB: /
Dieses Gerät funktioiert nur mit den folgenden EASY RGB Controllern: /
Questo dispositivo funziona unicamente con i regolatori EASY RGB: /
Este aparelho só funciona com os controladores EASY RGB: /
Этот аппарат работает только с контроллерами EASY RGB: /
To urządzenie działa tylko z driverami EASY RGB:
71-9630/ 71-9632



OUTDOOR | RECESSED

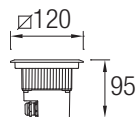

GEA NEW

55-9723-CA-37

3 LED CREE 100-240V 6,5W 621lm^(N)
Neutral white 4000K <40°C



EAGLE RISE

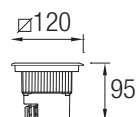

GEA NEW

55-9724-CA-37

3 LED PHILIPS 12VDC 6,5W RGB <40°C

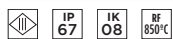

p.877

Este aparato sólo funciona con los controladores EASY RGB: /
This fitting only works with EASY RGB controllers: /
Cet appareil ne fonctionne qu'avec les contrôleurs EASY RGB: /
Dieses Gerät funktioiert nur mit den folgenden EASY RGB Controllern: /
Questo dispositivo funziona unicamente con i regolatori EASY RGB: /
Este aparelho só funciona com os controladores EASY RGB: /
Этот аппарат работает только с контроллерами EASY RGB: /
To urządzenie działa tylko z driverami EASY RGB:
71-9630/ 71-9632





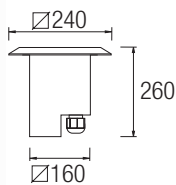

GEA 55-9232-Y4-37

G12 70W HID 230V **>80°C**



BAG

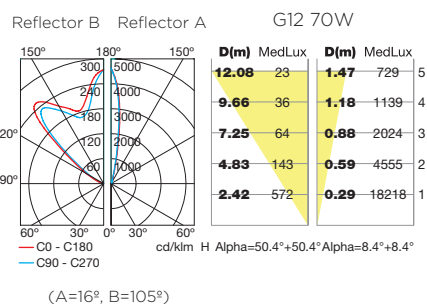
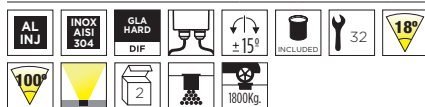

2 reflectores incluidos.
2 reflectors included.
2 réflecteurs inclus.
2 Reflektore inklusive.
2 riflettori inclusi.
2 reflectores incluidos
Прилагаются 2 отражателя.
2 odbłyśniki w komplecie

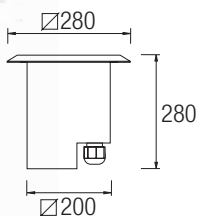

GEA 55-9233-Y4-37

G12 150W HID 230V **>80°C**



BAG

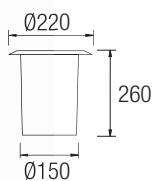
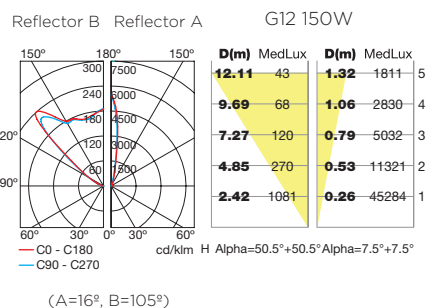

GEA 55-9433-Y4-37

Rx7s 70W HID 230V **>80°C**



BAG

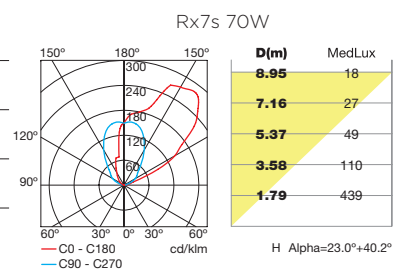

71-9453-CA-CA

Aro de acero inoxidable AISI 316 para / AISI 316 Stainless steel ring for / Anneau en acier inoxydable AISI 316 pour / Ring aus Edelstahl AISI 316 für / Anello d'acciaio inossidabile AISI 316 per / Aro de aço inoxidável AISI 316 para / Кольцо из нержавеющей стали AISI 316 для / Obręcz ze stali nierdzewnej AISI 316 dla **55-9433**



71-9638-CA-CA

Marco de acero inoxidable AISI 316 para / AISI 316 Stainless steel frame for / Cadre en acier inoxydable AISI 316 pour / Rahmen aus Edelstahl AISI 316 für / Cornice in acciaio inossidabile AISI 316 per / Aro de aço inoxidável AISI 316 para / Рамка из нержавеющей стали AISI 316 для / Obramowanie ze stali nierdzewnej AISI 316 dla **55-9433**





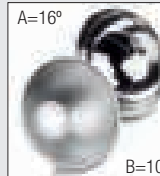

2 reflectores incluidos.
2 reflectors included.
2 réflecteurs inclus.
2 Reflektore inklusive.
2 riflettori inclusi.
2 reflectores incluidos
Прилагаются 2 отражателя.
2 odbłyśniki w komplecie

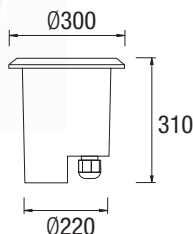

GEA

55-9625-CA-37 ■ INOX AISI 316

55-9625-Y4-37 ■ INOX AISI 304

G12 150W HID 230V >80°C

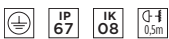

BAG

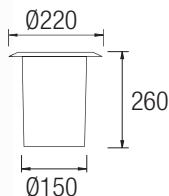
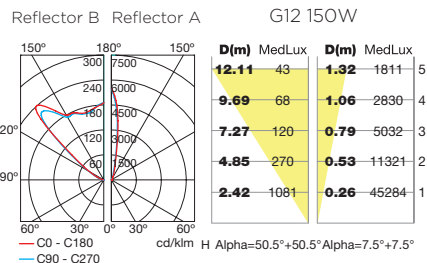

GEA

55-9187-CA-37 ■ INOX AISI 316

55-9187-Y4-37 ■ INOX AISI 304

G12 70W HID 230V >80°C



BAG

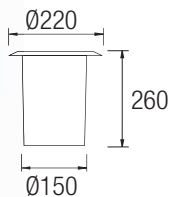
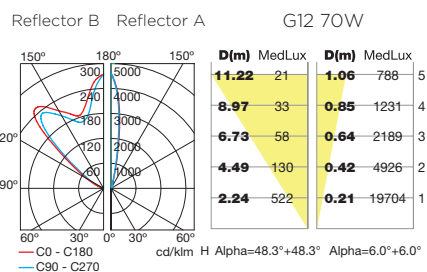

GEA

55-9323-Y4-37 ■

G12 35W HID 230V 40-80°C



BAG

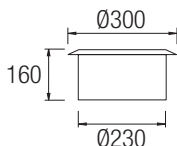
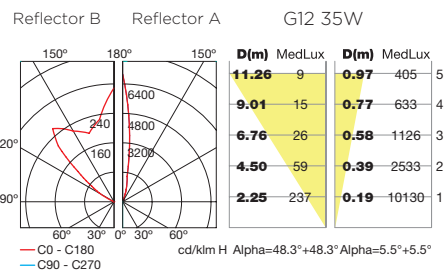
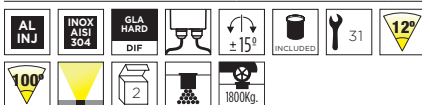

71-9187-Y4-37 ■

Accesorio para / Accessory for / Accessoire pour / Zubehör für / Accessorio per / Acessório para / Принадлежность для / Akcesorium do **55-9187 / 55-9323**

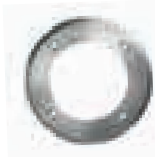
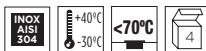

71-9453-CA-CA ■

Aro de acero inoxidable AISI 316 para / AISI 316 Stainless steel ring for / Anneau en acier inoxydable AISI 316 pour / Ring aus Edelstahl AISI 316 für / Anello d'acciaio inossidabile AISI 316 per / Aro de aço inoxidável AISI 316 para / Кольцо из нержавеющей стали AISI 316 для / Obręcz ze stali nierdzewnej AISI 316 dla **55-9323**



71-9638-CA-CA ■

Marco de acero inoxidable AISI 316 para / AISI 316 Stainless steel frame for / Cadre en acier inoxydable AISI 316 pour / Rahmen aus Edelstahl AISI 316 für / Cornice in acciaio inossidabile AISI 316 per / Aro de aço inoxidável AISI 316 para / Рамка из нержавеющей стали AISI 316 для / Obramowanie ze stali nierdzewnej AISI 316 dla **55-9323, 55-9187**



OUTDOOR | RECESSED



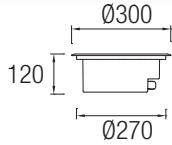

GEA 55-9564-Y4-37

G 8.5 20W HID 220-240V 40-80°C



TRIDONIC

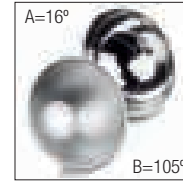
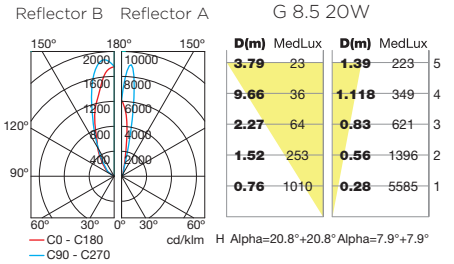

2 reflectores incluidos.
2 reflectors included.
2 réflecteurs inclus.
2 Reflektore inklusive.
2 riflettori inclusi.
2 reflectores incluidos
Прилагаются 2 отражателя.
2 odbłyśniki w komplecie

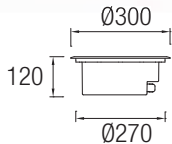

GEA 55-9486-Y4-37

G 8.5 35W HID 230V 40-80°C



BAG

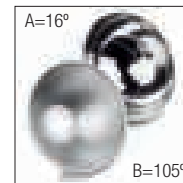
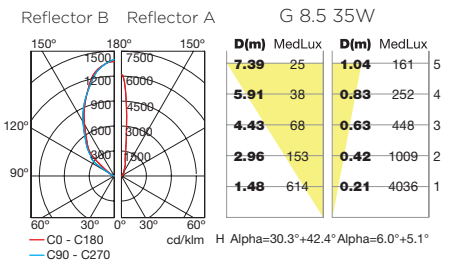

2 reflectores incluidos.
2 reflectors included.
2 réflecteurs inclus.
2 Reflektore inklusive.
2 riflettori inclusi.
2 reflectores incluidos
Прилагаются 2 отражателя.
2 odbłyśniki w komplecie



71-9512-CA-CA

Aro de acero inoxidable AISI 316 para / AISI 316 Stainless steel ring for / Anneau en acier inoxydable AISI 316 pour / Ring aus Edelstahl AISI 316 für / Anello d'acciaio inossidabile AISI 316 per / Aro de aço inoxidável AISI 316 para / Кольцо из нержавеющей стали AISI 316 для / Obręcz ze stali nierdzewnej AISI 316 dla **55-9486, 55-9564**

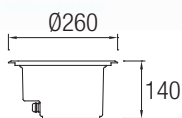

GEA 55-9430-Y4-T2

2 x GX24d-3 26W 230V >80°C



BAG

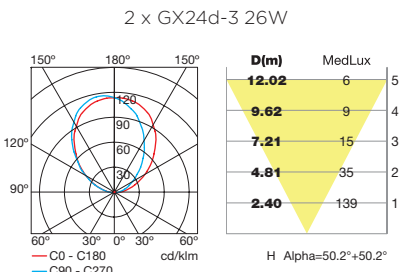

71-9454-CA-CA

Aro de acero inoxidable AISI 316 para / AISI 316 Stainless steel ring for / Anneau en acier inoxydable AISI 316 pour / Ring aus Edelstahl AISI 316 für / Anello d'acciaio inossidabile AISI 316 per / Aro de aço inoxidável AISI 316 para / Кольцо из нержавеющей стали AISI 316 для / Obręcz ze stali nierdzewnej AISI 316 dla **55-9430**





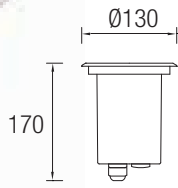

GEA

55-9280-CA-37 ■ INOX AISI 316

55-9280-Y4-37 ■ INOX AISI 304

GU-10 max. 50W / max. L=82mm

Halogen >80°C - Fluorescent 40-80°C - LED <40°C

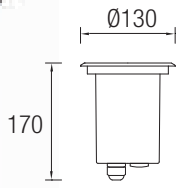
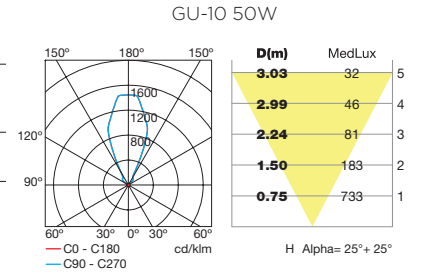
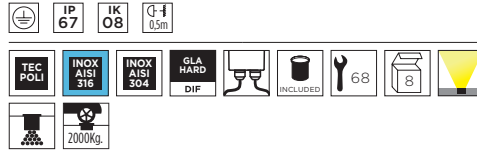

GEA

55-9567-Z5-37 ■

GU-10 max. 50W / max. L=80mm

Halogen >80°C - Fluorescent 40-80°C - LED <40°C

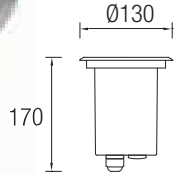
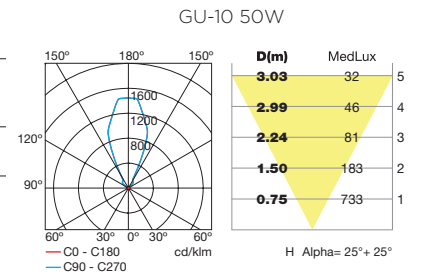
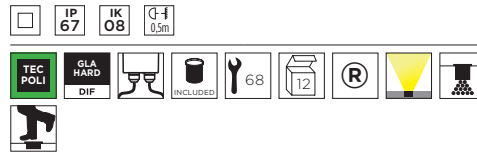

GEA

55-9380-CA-37 ■ INOX AISI 316

55-9380-Y4-37 ■ INOX AISI 304

GU-10 max. 50W / max. L=55mm

Halogen >80°C - Fluorescent 40-80°C - LED <40°C

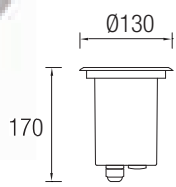
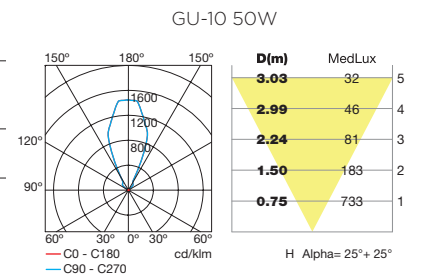
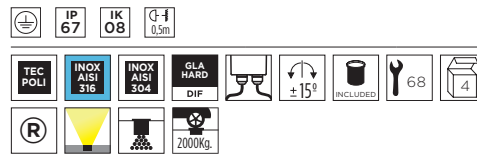

GEA

55-9635-CA-37 ■

MR16 max. 50W - 12 VAC

Halogen >80°C - LED <40°C

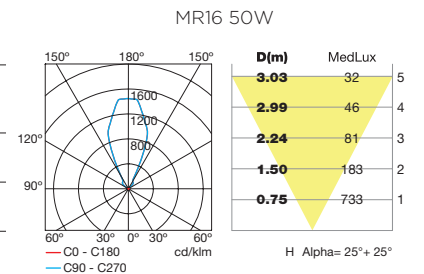
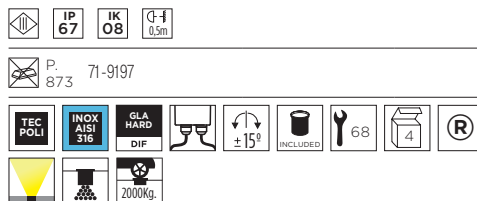

OUTDOOR | RECESSED





ALCOLEA PSYCHIATRIC CENTER. CÓRDOBA, SPAIN.

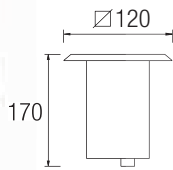

GEA NEW

55-9737-CA-37

GU-10 max. 50W / max. L=55mm
Halogen >80°C - Fluorescent 40-80°C - LED <40°C

GU-10 50W

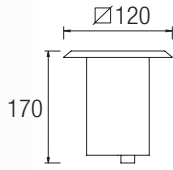
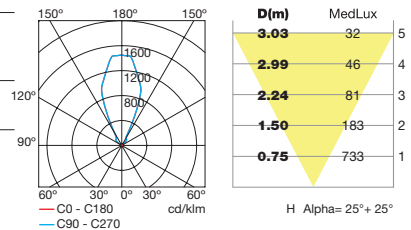

GEA

55-9281-Y4-37

GU-10 max. 50W / max. L=80mm (LED max.5W)
Halogen >80°C - Fluorescent 40-80°C - LED <40°C

GU-10 50W

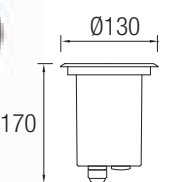
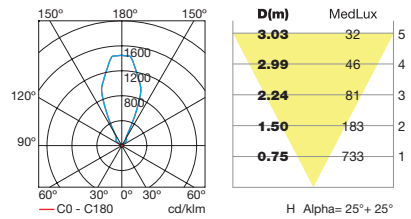

GEA

55-9282-Y4-T2

15 LED 230V 1W 160lm^(N)
Cool White 6500K <40°C

LED 1W

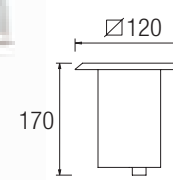
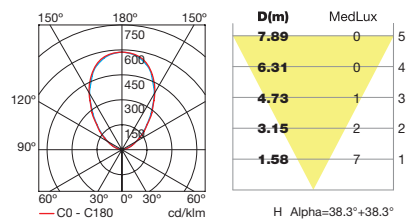

GEA

55-9283-Y4-T2 (S)

15 LED 230V 1W 160lm^(N)
Cool White 6500K <40°C

LED 1W

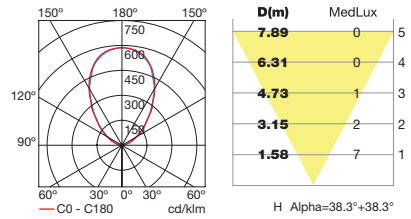

71-9448-CA-CA

Aro de acero inoxidable AISI 316 para / AISI 316 Stainless steel ring for / Anneau en acier inoxydable AISI 316 pour / Ring aus Edelstahl AISI 316 für / Anello d'acciaio inossidabile AISI 316 per / Aro de aço inoxidável AISI 316 para / Кольцо из нержавеющей стали AISI 316 для / Obręcz ze stali nierdzewnej AISI 316 dla **55-9282**



71-9449-CA-CA

Marco de acero inoxidable AISI 316 para / AISI 316 Stainless steel frame for / Cadre en acier inoxydable AISI 316 pour / Rahmen aus Edelstahl AISI 316 für / Cornice in acciaio inossidabile AISI 316 per / Aro de aço inoxidável AISI 316 para / Рамка из нержавеющей стали AISI 316 для / Obramowanie ze stali nierdzewnej AISI 316 dla **55-9281, 55-9283**



OUTDOOR | RECESSED



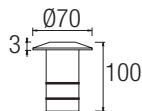

GEA

55-9255-54-37

MR11 max. 20W - 12V AC Halogen >80°C



12V AC P.873



MR11 20W

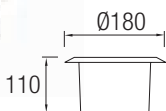
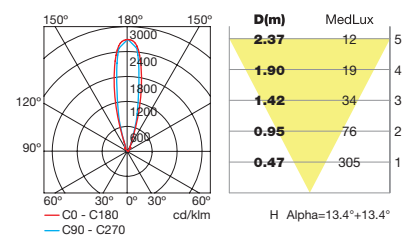

GEA

55-9337-Y4-37

G-53 12V AC max. 75W
Halogen >80°C - LED <40°C



12V AC P.873

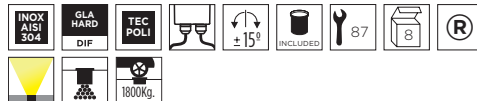

QR-R 111 60W

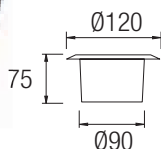
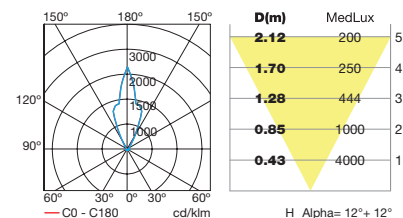

GEA

55-9184-Y4-37

GX 53 max. 9W
Fluorescent 40-80°C - LED <40°C



GX 53 9W

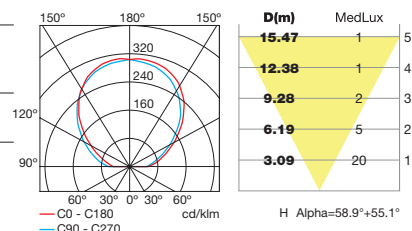

71-9450-CA-CA

Aro de acero inoxidable AISI 316 para / AISI 316 Stainless steel ring for /
Anneau en acier inoxydable AISI 316 pour / Ring aus Edelstahl AISI 316 für /
Anello d'acciaio inossidabile AISI 316 per / Aro de aço inoxidável AISI 316 para /
Кольцо из нержавеющей стали AISI 316 для / Obłęcz ze stali nierdzewnej
AISI 316 dla 55-9184

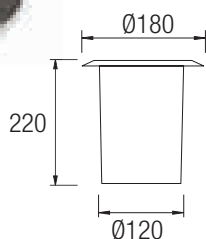

GEA

55-9186-CA-37 INOX AISI 316

55-9186-Y4-37 INOX AISI 304

Par-30 E-27 max. 75W / max. L=160mm
Halogen 40-80°C - Fluorescent 40-80°C - LED <40°C



PAR-30 75W

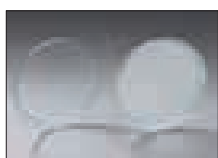
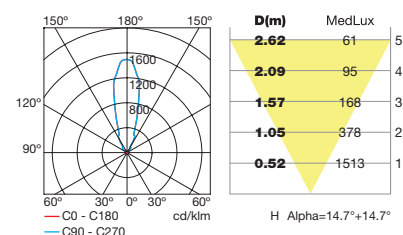

2 cristales incluidos.
2 glasses included.
2 verres compris.
2 Gläser inklusive.
2 vetri inclusi.
2 vidros incluidos.
Прилагаются 2 стекла.
2 szyby w komplecie.

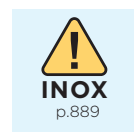

71-9452-CA-CA

Aro de acero inoxidable AISI 316 para / AISI 316 Stainless steel ring
for / Anneau en acier inoxydable AISI 316 pour / Ring aus Edelstahl
AISI 316 für / Anello d'acciaio inossidabile AISI 316 per / Aro de aço
inoxidável AISI 316 para / Кольцо из нержавеющей стали AISI 316 для /
Obłęcz ze stali nierdzewnej AISI 316 dla 55-9337



71-9639-CA-CA

Marco de acero inoxidable AISI 316 para / AISI 316 Stainless steel
frame for / Cadre en acier inoxydable AISI 316 pour / Rahmen aus
Edelstahl AISI 316 für / Cornice in acciaio inossidabile AISI 316 per /
Aro de aço inoxidável AISI 316 para / Рамка из нержавеющей стали
AISI 316 для / Obramowanie ze stali nierdzewnej AISI 316 dla 55-9337,
55-9186





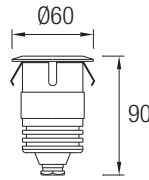

GEA

55-9620-54-T2

LED CREE 100-240V 1W 122lm^(N)
Neutral White 4000K <40°C

IP 67 IK 05

EAGLE RISE

AL ANOD GLA HARD DIF INCLUDED 46 12 FILTER 3000K 2,5 m

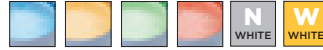

LED 1W

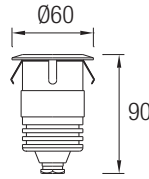
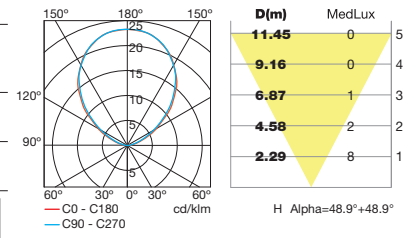

GEA

55-9621-54-T2

LED CREE 1W 350mA / 2W 700mA 122lm^(N)/
207lm^(N) Neutral White 4000K <40°C

IP 67 IK 05

P.862-863

AL ANOD GLA HARD DIF INCLUDED 46 12 FILTER 3000K

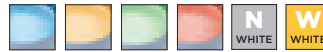

LED 1W

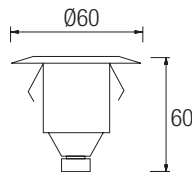
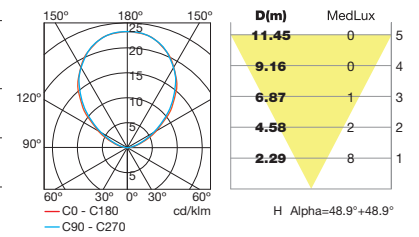

GEA NEW

55-9769-54-T2

12 LED 12V AC/DC 1W 96lm^(N)
Neutral White 4000K <40°C

IP 66 IK 05

12V AC P.873 / 12V DC P.872

AL ANOD GLA MAT DIF INCLUDED 61 20 FILTER 3000K 2,5 m

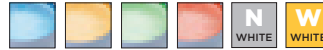

LED 1W

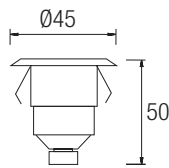
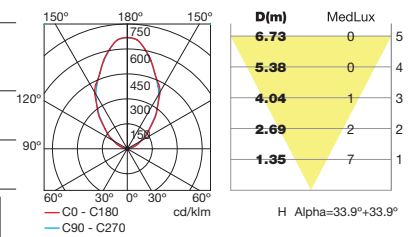

GEA NEW

55-9768-54-T2

6 LED 12V AC/DC 0,5W 48lm^(N)
Neutral White 4000K <40°C

IP 66 IK 05

12V AC P.873 / 12V DC P.872

AL ANOD GLA MAT DIF INCLUDED 72 36 FILTER 3000K 2,5 m



LED 0,5W

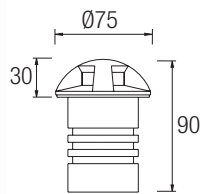
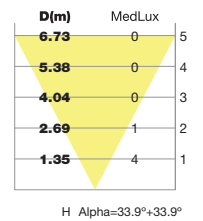

GEA

55-9257-54-M2

LED 1W 350mA 80lm^(N)
Neutral White 4000K <40°C

IP 68 IK 10

P.862-863

AL ANOD PC TRAN DIF INCLUDED 57 8 1000kg

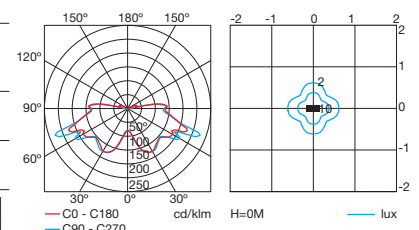

OUTDOOR | RECESSED



DAMM AREA, F.C. BARCELONA STADIUM. BARCELONA, SPAIN.

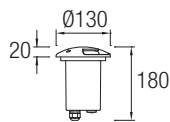

XENA

55-9422-34-M3 ■

55-9422-Z5-M3 ■

6 LED 230V 0,5W 64lm^(N)
Neutral White 4000K <40°C

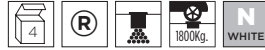

LED 6 x 0,1W

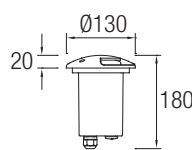
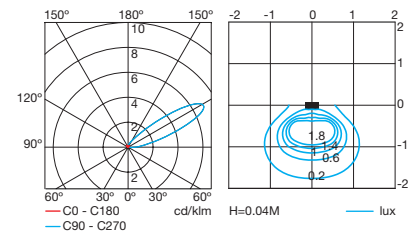

XENA

55-9423-34-T2 ■

55-9423-Z5-T2 ■

12 LED 230V 1W 128lm^(N)
Neutral White 4000K <40°C

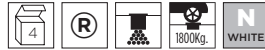

LED 12 x 0,1W

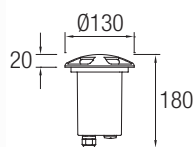
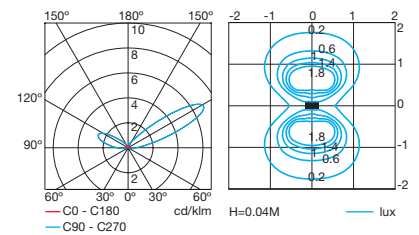

XENA

55-9424-34-T2 ■

55-9424-Z5-T2 ■

12 LED 230V 1W 128lm^(N)
Neutral White 4000K <40°C

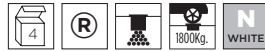

LED 12 x 0,1W

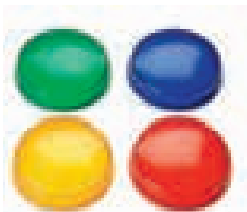
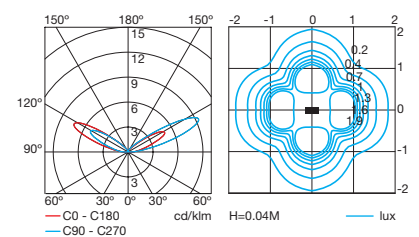

71-9476-08-08 ■

71-9476-11-11 ■

71-9476-24-24 ■

71-9476-25-25 ■

Filtros de colores para las referencias; /Colour filters for references; / Filtres de couleurs pour les références; / Farbfilter für die Art.-Nr / Filtri colorati per i codici; / Filtros de cores para as referências; / Цветовые фильтры для артикулов; / Filtry kolorów dla nr referencyjnych; **55-9422/ 55-9423/ 55-9424**



Cada código incluye 2 filtros.
Each code includes 2 filters.
Chaque code comprend 2 filtres.
Jede Artikel-Nr. enthält 2 Filter.
Ogni codice comprende 2 filtri.
Cada código inclui 2 filtros.
Каждый код включает 2 фильтра.
Každy kod zawiera 2 filtry.



OUTDOOR | RECESSED



PLAÇA VALL. TORÀ, SPAIN.

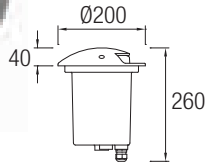

XENA

55-9426-34-M3 ■

55-9426-Z5-M3 ■

E-27 max. 20W / max. L=175mm

Fluorescent 40-80°C - LED <40°C

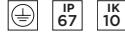

PL 20W

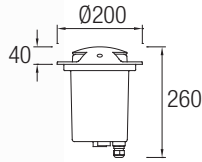
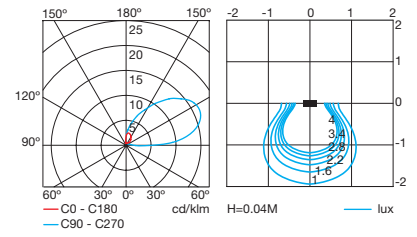

XENA

55-9427-34-T2 ■

55-9427-Z5-T2 ■

E-27 max. 20W / max. L=175mm

Fluorescent 40-80°C - LED <40°C



PL 20W

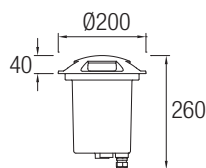
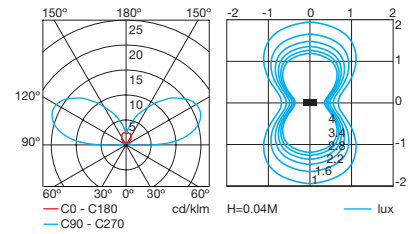

XENA

55-9428-34-T2 ■

55-9428-Z5-T2 ■

E-27 max. 20W / max. L=175mm

Fluorescent 40-80°C - LED <40°C



PL 20W

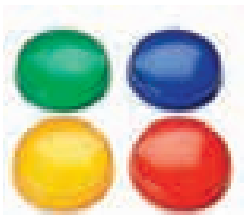
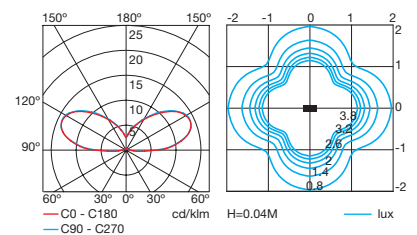

Cada código incluye 2 filtros.
Each code includes 2 filters.
Chaque code comprend 2 filtres.
Jede Artikel-Nr. enthält 2 Filter.
Ogni codice comprende 2 filtri.
Cada código inclui 2 filtros.
Каждый код включает 2 фильтра.
Každy kod zawiera 2 filtry.

71-9477-08-08 ■

71-9477-11-11 ■

71-9477-24-24 ■

71-9477-25-25 ■

Filtros de colores para las referencias: / Colour filters for references: / Filtres de couleurs pour les références: / Farbfilter für die Art.-Nr / Filtri colorati per i codici: / Filtros de cores para as referências: / Цветовые фильтры для артикулов: / Filtry kolorów dla nr referencyjnych: / **55-9426 / 55-9427 / 55-9428**



OUTDOOR | RECESSED





REXEL NEW

55-9741-Z5-37 ■

4 LED CREE 100-240V 4,3W 348lm⁽ⁿ⁾
Warm White 3000K

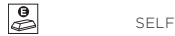

SELF

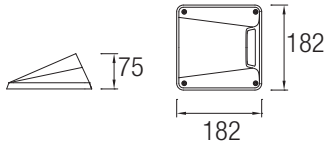
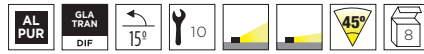

Montaje en superficie./ Surface mounted./ Montage en surface./
Aufbaumontage./ Montaggio in superficie./ Montagem à superfície./
Монтаж на поверхности./ Montaż na powierzchni.



XENA

55-9421-M3-M3 ■

GU-10 max. 11W / max. L=80mm
Fluorescent <40°C - LED <40°C

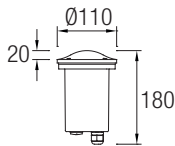
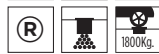

GU-10 11W Fluo

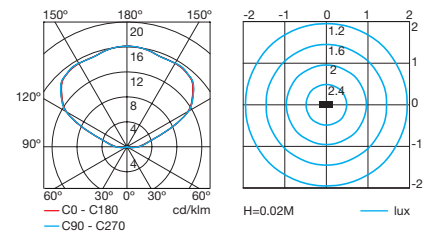

XENA

55-9425-M3-M3 ■

Par-38 E-27 max.23W / max. L=170mm
Fluorescent <40°C - LED <40°C

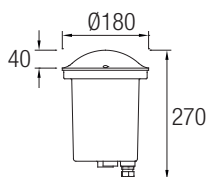
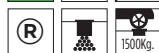

PAR-38 23W

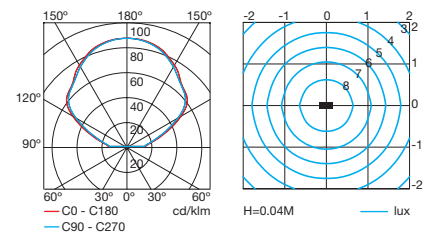



MARRIOTT RENAISSANCE TUSCANY IL CIOCCO RESORT & SPA. BARGA, ITALY.

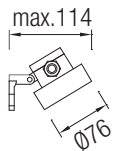

AQUA NEW

05-9727-05-M2 ■

3 LED CREE 12V AC/DC 7W 561lm^(N)
Neutral White 4000K



12V AC P.873 / 12V DC P.872

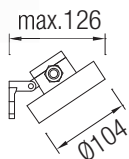

AQUA NEW

05-9728-05-M2 ■

9 LED CREE 12V AC/DC 21W 1683lm^(N)
Neutral White 4000K



12V AC P.873 / 12V DC P.872

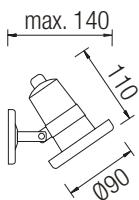

AQUA NEW

05-9245-CA-37 ■

MR-16 max. 50W / max. L= 55mm - 12VAC
Halogen - Fluorescent - LED



12V AC P.873



MR16 50W

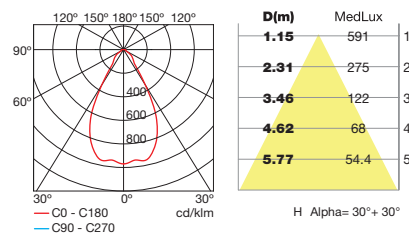



AQUA

55-9697-14-M3

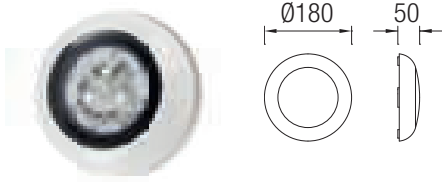

3 LED PHILIPS 12V AC/DC 6W 615lm^(N)
Neutral White 4000K <40°C



12V AC P.873 / 12V DC P.872



Montaje en superficie./ Surface mounted./ Montage en surface./ Aufbaumontage/
Montaggio in superficie./ Montagem em superfície./ Монтаж на поверхности./ Montaż
na powierzchni.

AQUA

55-9698-14-M3

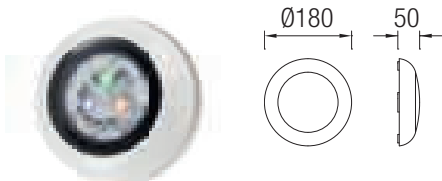

3 LED PHILIPS **EASY RGB** 6W 453lm^(N) <40°C



Montaje en superficie./ Surface mounted./ Montage en surface./ Aufbaumontage/
Montaggio in superficie./ Montagem em superfície./ Монтаж на поверхности./ Montaż
na powierzchni.



p.877

Este aparato sólo funciona con los controladores EASY RGB: /
This fitting only works with EASY RGB controllers: /
Cet appareil ne fonctionne qu'avec les contrôleurs EASY RGB: /
Dieses funktioniert nur mit den folgenden EASY RGB Controllern: /
Questo dispositivo funziona unicamente con i regolatori EASY RGB: /
Este aparelho só funciona com os controladores EASY RGB: /
Этот аппарат работает только с контроллерами EASY RGB: /
To urządzenie działa tylko z driverami EASY RGB:

71-9630/ 71-9632

AQUA

55-9699-14-M3



9 LED PHILIPS 12V AC/DC 18W 1845lm^(N)
Neutral White 4000K <40°C

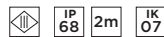

12V AC P.873 / 12V DC P.872



Montaje en superficie./ Surface mounted./ Montage en surface./ Aufbaumontage/
Montaggio in superficie./ Montagem em superfície./ Монтаж на поверхности./ Montaż
na powierzchni.

AQUA

55-9700-14-M3



9 LED PHILIPS **EASY RGB** 18W 1360lm^(N) <40°C

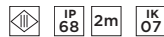

Montaje en superficie./ Surface mounted./ Montage en surface./ Aufbaumontage/
Montaggio in superficie./ Montagem em superfície./ Монтаж на поверхности./ Montaż
na powierzchni.



p.877

Este aparato sólo funciona con los controladores EASY RGB: /
This fitting only works with EASY RGB controllers: /
Cet appareil ne fonctionne qu'avec les contrôleurs EASY RGB: /
Dieses funktioniert nur mit den folgenden EASY RGB Controllern: /
Questo dispositivo funziona unicamente con i regolatori EASY RGB: /
Este aparelho só funciona com os controladores EASY RGB: /
Этот аппарат работает только с контроллерами EASY RGB: /
To urządzenie działa tylko z driverami EASY RGB:

71-9630/ 71-9632



OUTDOOR | SUBMERSIBLE



MARRIOTT RENAISSANCE TUSCANY IL CIOCCO RESORT & SPA. BARGA, ITALY.

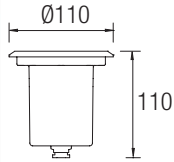

AQUA

55-9245-CA-37

MR-16 max. 50W - 12VAC / max. L=60mm
Halogen **>80°C** - LED **<40°C**

IP 68 1m IK 08 Rf 850°C

12V AC P.873



MR16 50W

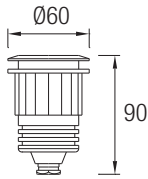
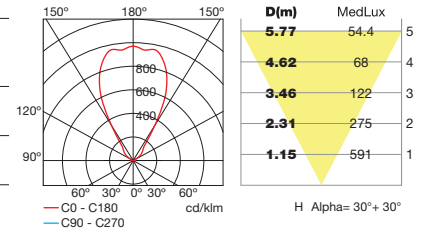

AQUA

55-9622-14-T2

LED CREE 1W 350mA 122lm^(N) /
3W 700mA 207lm^(N)
Neutral White 4000K **<40°C**

IP 68 1m IK 05

P.862-863



LED 1W

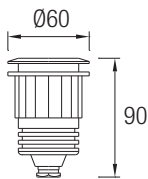
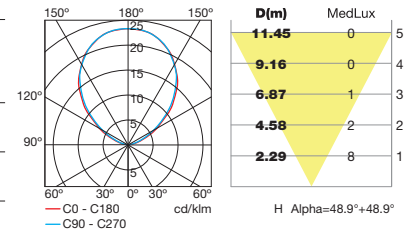

AQUA

55-9623-14-T2

12 LED 12V AC/DC 1W 96lm^(N)
Neutral White 4000K **<40°C**

IP 68 1m IK 05

12V AC P.873 / 12V DC P.872

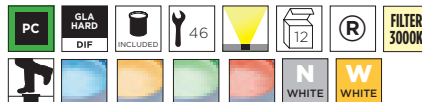

LED 1W

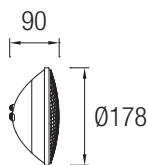
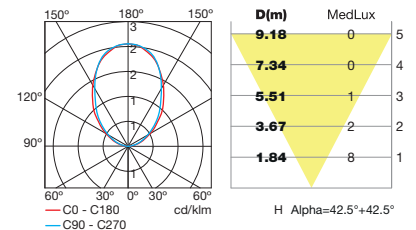

AQUA NEW

71-9729-54-M3

120 LED SAMSUNG 12V AC/DC 43W 4800lm^(N)
Neutral White 4000K

IP 68 2m IK 10

12V AC P.873 / 12V DC P.872



Para substituir lampara PAR 56. / To replace PAR 56 bulb. / Pour remplacer l'ampoule PAR 56. / Um Lampe PAR 56 ersetzen. / Per sostituire la lampadina PAR 56. / Para substituir lâmpada PAR 56. / Для замены лампы PAR 56. / Aby wymienić żarówkę 56 PAR.





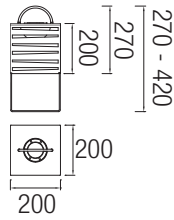

ARI **NEW**

10-9784-14-M2

LED 0,1W 8lm^(N)
Warm white 3000K



SENSOR CREPUSCULAR. / TWILIGHT SENSOR / CAPTEUR CRÉPUSCULAIRE / DÄMMERUNGSSENSOR. / SENSORE CREPUSCOLARE. / SENSOR CREPUSCULAR. / СУМЕРЕЧНЫЙ ДАТЧИК / CZUJNIK ZAPADANIA ZMIERZCHU.

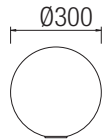

CISNE

55-9155-M1-M1

E-27 max. 100W
Halogen - Fluorescent - LED

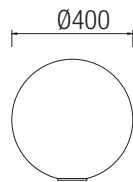
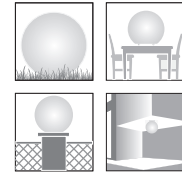
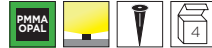

CISNE

55-9156-M1-M1

E-27 max. 150W
Halogen - Fluorescent - LED

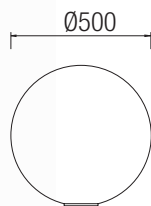
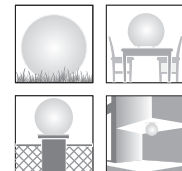

CISNE

55-9481-M1-M1

E-27 max. 150W
Halogen - Fluorescent - LED

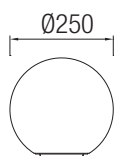
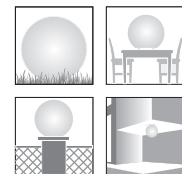

CISNE **NEW**

55-9756-M1-M1

LED 100-240V 2W RGB



Mando y cargador incluido.
Remote and charger included.
Télécommande et chargeur fournis.
Fernbedienung und Ladegerät mitgeliefert
Telecomando e caricatore inclusi.
Comando e carregador incluidos.
Пульт управления и зарядное устройство
поставляются в комплекте.
Zawarty pilot i ładowarka.





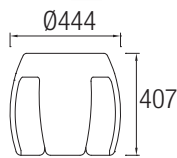

ROCK NEW

55-9754-M1-M1

LED 100-240V 3W RGB



1 mando y 2 cargadores incluidos.
 1 remote and 2 chargers included.
 1 télécommande et 2 chargeurs fournis.
 1 Fernbedienung und 2 Ladegeräte im Lieferumfang enthalten.
 1 telecomando e 2 caricatori inclusi.
 1 comando e 2 carregadores incluídos.
 1 пульт управления и 2 зарядных устройства поставляются в комплекте.
 Zawarte: 1 pilot i 2 ładowarki.



Un código incluye 2 sillas.
 Includes two seats per unit.
 Un code comprend 2 chaises.
 Zu einer Art.-Nr. gehören 2 Stühle.
 Un codice comprende 2 sedie.
 Um código inclui 2 cadeiras.
 Один код включает 2 стула.
 Jeden kod zawiera 2 krzesła.

Puede usarse como asiento. Máx. 110 Kg.
 Can be used as a seat. Max 110 Kg
 Peut servir de siège. 110 kg maxi.
 Kann als Sitz verwendet werden. Max. 110 kg
 Può essere utilizzato come sedia. Max. 110 kg.
 Pode usar-se como assento. Máx. 110 kg.
 Может использоваться как сиденье. Макс. 110 кг.
 Można użyć jako siedziska. Maks. 110 kg.



OUTDOOR | CHILLOUT

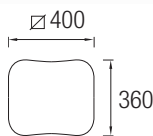

ROCK

55-9520-M1-M1

LED 230V 5W RGB



Puede usarse como asiento. Máx. 110 Kg.
 Can be used as a seat. Max 110 Kg
 Peut servir de siège. 110 kg maxi.
 Kann als Sitz verwendet werden. Max. 110 kg
 Può essere utilizzato come sedia. Max. 110 kg.
 Pode usar-se como assento. Máx. 110 kg.
 Может использоваться как сиденье. Макс. 110 кг.
 Można użyć jako siedziska. Maks. 110 kg.

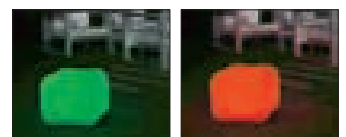

71-9520-00-00

Un mando a distancia puede controlar multitud de cubos 55-9520.
 A single remote control can be used for several 55-9520 cubes.
 Une seule télécommande peut contrôler de nombreux cubes 55-9520.
 Mit einer Fernbedienung lassen sich mehrere Würfel 55-9520 steuern.
 Un telecomando può controllare diversi cubi 55-9520.
 Um comando à distância pode controlar vários cubos 55-9520.
 Один пульт может управлять множеством кубов 55-9520.
 Pilot zdalnego sterowania może kontrolować wiele układów 55-9520.







KAP

55-9669-14-M1

4 x E-27 max. 13W / max. L=120mm Ø=50mm
Fluorescent - LED



IP
65



P.
609

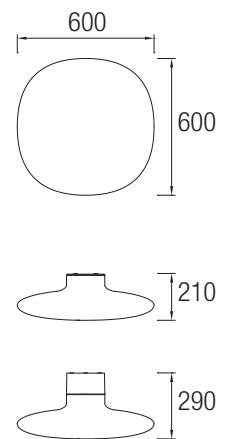
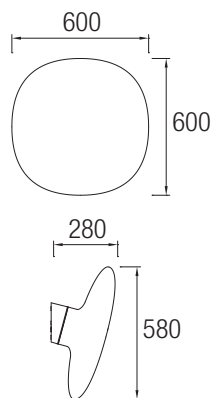
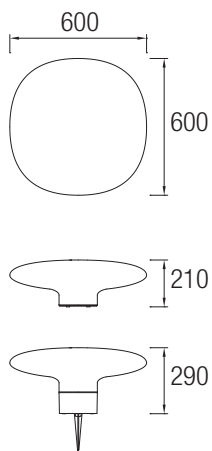
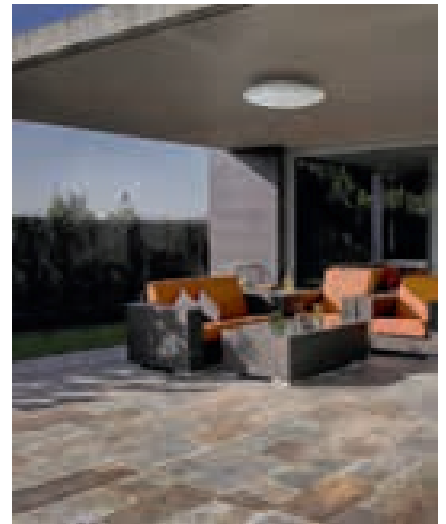
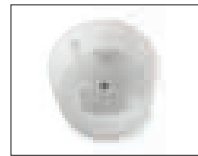

OUTDOOR | CHILLOUT



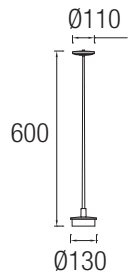

INVISIBLE NEW

55-9733-05-M1 ■

27 LED 100-240V 10W 864lm^(N)
Warm white 3000K

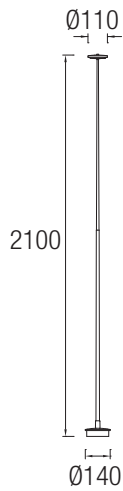

INVISIBLE NEW

25-9733-05-M1 ■

27 LED 100-240V 10W 864lm^(N)
Warm white 3000K

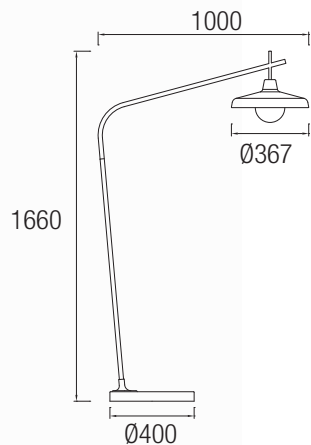
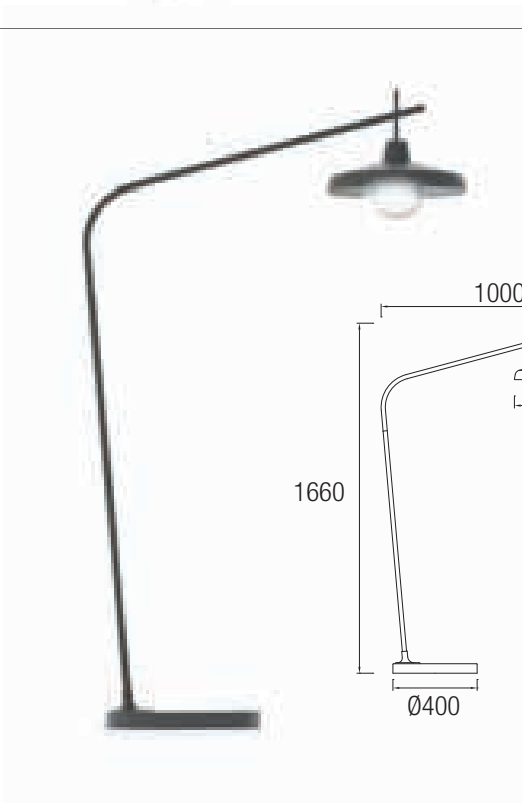

JAMBO NEW

25-9742-Z5-M1 ■

E-27 max. 18W / max. L=120mm Ø=50
Fluorescent - LED





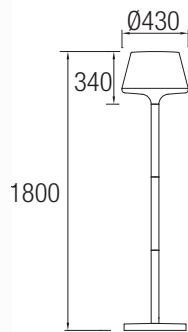
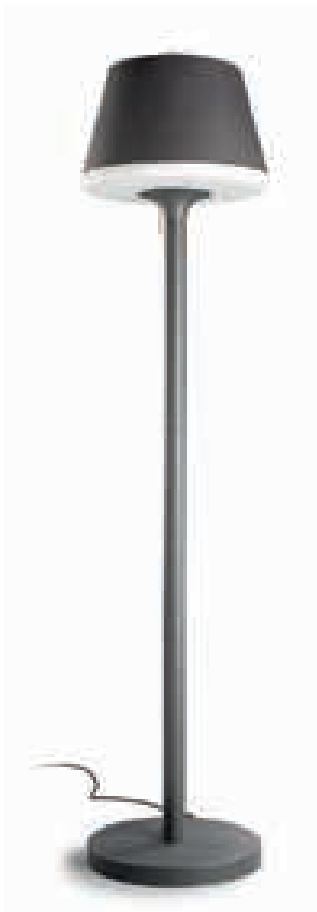

MOONLIGHT

25-9503-14-M1

25-9503-Z5-M1

E-27 max. 100W

Halogen - Fluorescent - LED

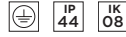

Incluye interruptor y pantalla opaca./ Includes switch and opaque screen./
Comprend interrupteur et abat-jour opaque./ Einschließlich Schalter und
opakem Schirm./ Contiene interruttore e schermo opaco./ Inclui interruptor
e quebra-luz opaco./ В комплект входит выключатель и непрозрачный
абажур./ Zawiera wyłącznik i nieprzezroczysty abażur.

Base para fijar al suelo incluida./ Base for fixing to ground included./ Socle
à fixer au sol fourni./ Bodenplatte zur Befestigung am Boden mitgeliefert./
Base da fissare nel pavimento inclusa./ Base para fixar ao chão incluida./
В комплект входит основа для фиксации к полу./ Zawarta podstawa do
przytworzenia do podłogi.



25-9503-Z5-M1

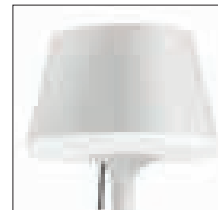

25-9503-14-M1

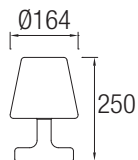
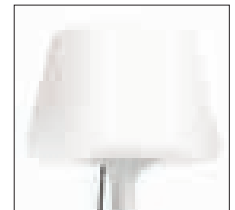

MOONLIGHT NEW

10-9755-M1-M1

LED 100-240V 1W RGB



Mando y cargador incluido.
Remote and charger included.
Télécommande et chargeur fournis.
Fernbedienung und Ladegerät mitgeliefert
Telecomando e caricatore inclusi.
Comando e carregador incluídos.
Пульт управления и зарядное устройство
поставляются в комплекте.
Zawarty pilot i ładowarka.





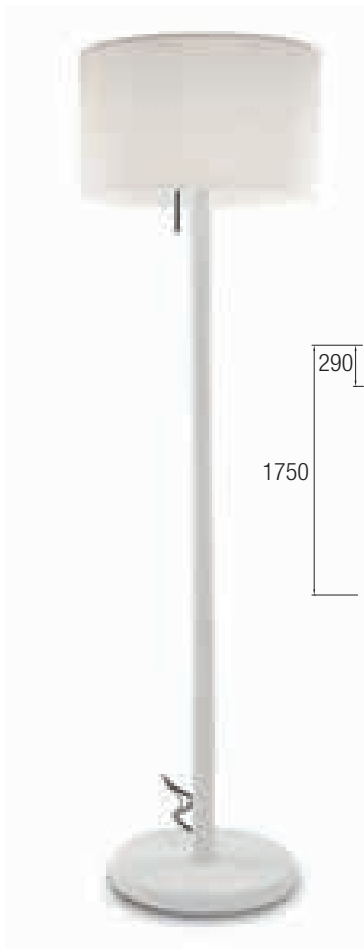

SMOOTH

25-9642-14-M1

LED 3 W 230V **RGB**

+
E-27 max. 30W / max. L=170mm
Fluorescent - LED



Interruptor incluido./ Switch included./ Interrupteur fourni./ Inkl. Schalter./
Interruttore incluso./ Interruptor incluido./ В комплект входит выключатель.
/ Zawiera wyłącznik.

Base para fijar al suelo incluida./ Base for fixing in the ground included./
Socle à fixer au sol fourni./ Bodenplatte zur Befestigung am Boden
mitgeliefert./ Base di fissazione a pavimento inclusa./ Base para fixar ao
chão incluida./ В комплект входит основа для фиксации к полу./ Zawarta
podstawa do przymocowania do podłogi.

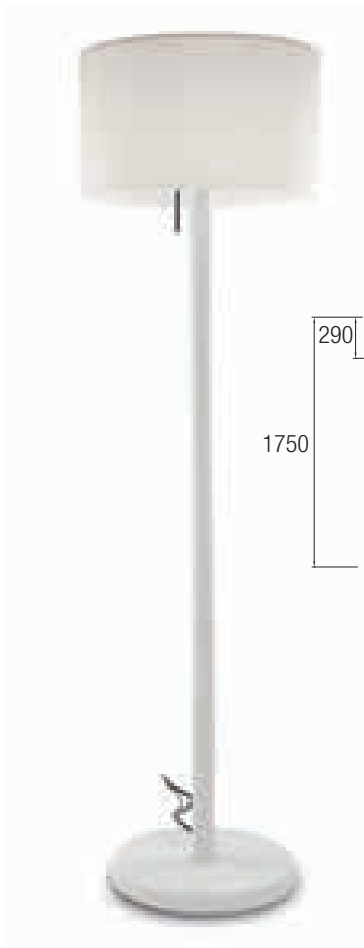
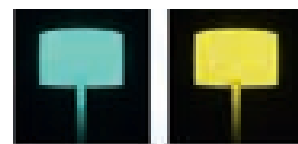

SMOOTH

25-9614-14-M1

E-27 max. 100W / max. L=170mm
Halogen - Fluorescent - LED



Interruptor incluido./ Switch included./ Interrupteur fourni./ Inkl. Schalter./
Interruttore incluso./ Interruptor incluido./ В комплект входит выключатель.
/ Zawiera wyłącznik.

Base para fijar al suelo incluida./ Base for fixing in the ground included./
Socle à fixer au sol fourni./ Bodenplatte zur Befestigung am Boden
mitgeliefert./ Base di fissazione a pavimento inclusa./ Base para fixar ao
chão incluida./ В комплект входит основа для фиксации к полу./ Zawarta
podstawa do przymocowania do podłogi.





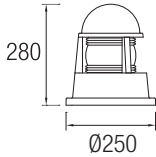

ODIN

10-9645-Z5-M2 ■

E-27 max. 60W / max. L=180mm
Halogen - Fluorescent - LED

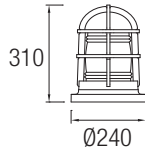
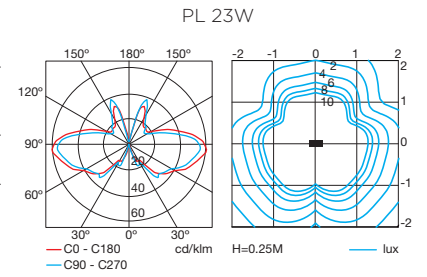
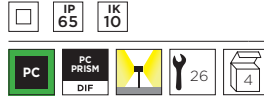

MARINER

10-9475-Z5-M2 ■

E-27 max. 60W / max. L=180mm
Halogen - Fluorescent - LED

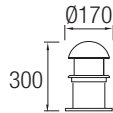
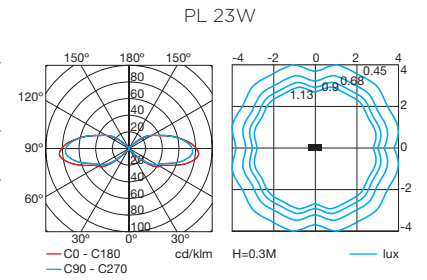
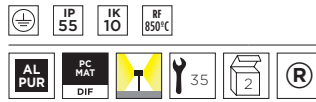

BALIZAS

55-9334-Z5-M3 ■

E-27 max. 100W / max. L=170mm
Halogen - Fluorescent - LED

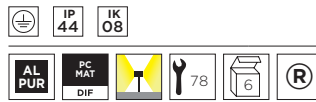

P. 695, 697, 709

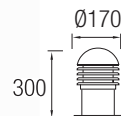
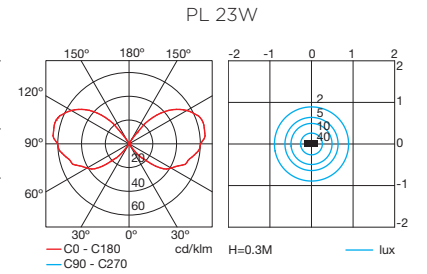

BALIZAS

55-9318-34-M3 ■

55-9318-Z5-M3 ■

E-27 max. 100W / max. L=170mm
Halogen - Fluorescent - LED

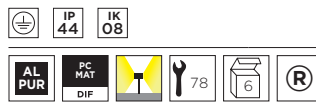

P. 695, 697, 709

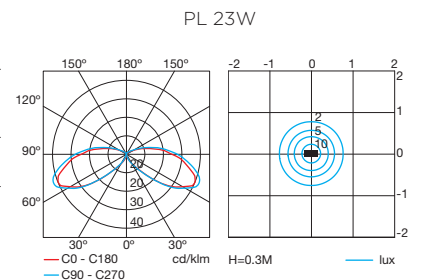



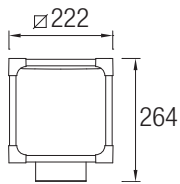

VINTAGE NEW

10-9774-CC-M1 ■

192 LED 220-240V 13W 1344lm^(nd)
Warm white 3000K



EAGLE RISE



P. 579

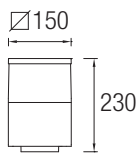

CUBIK

10-9386-34-M3 ■

10-9386-K7-M3 ■

10-9386-Z5-M3 ■

E-27 max. 60W / max. L=180mm
Halogen - Fluorescent - LED



P. 699

PL 13W

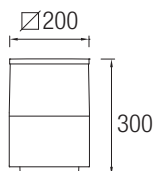
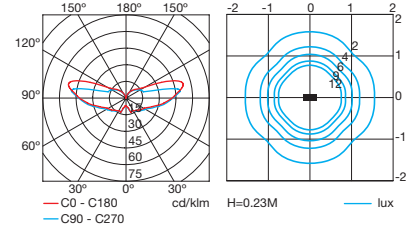

CUBIK

10-9387-34-M3 ■

10-9387-K7-M3 ■

10-9387-Z5-M3 ■

E-27 max. 100W / max. L=185mm
Halogen - Fluorescent - LED

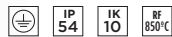

P. 699

PL 18W

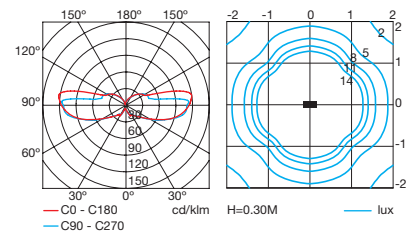



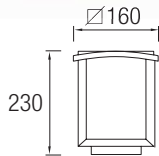

MARK

10-9298-Z5-M3 ■

E-27 max. 100W / max. L=185mm
Halogen - Fluorescent - LED

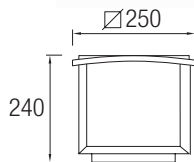
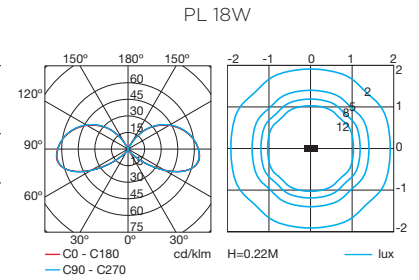
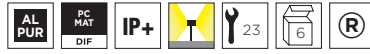

MARK

10-9299-14-M1 □ PC OPAL **NEW**

10-9299-Z5-M3 ■ PC MAT

E-27 max. 100W / max. L=185mm
Halogen - Fluorescent - LED

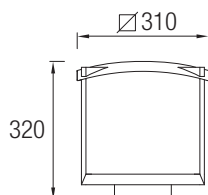
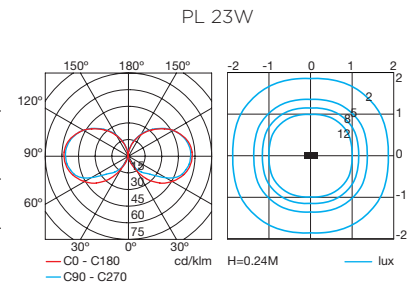
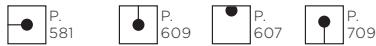

MARK

10-9390-Z5-M3 ■

E-27 max. 150W / max. L=220mm
Halogen - Fluorescent - LED

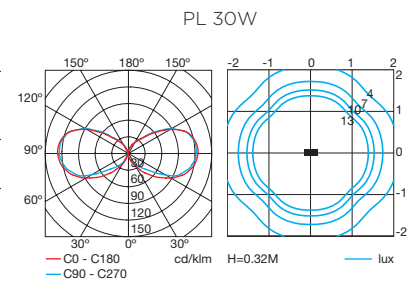
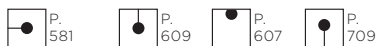



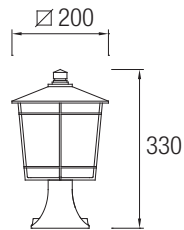

JANNA

10-9447-18-M3 ■

E-27 max. 18W / max. L=160mm
Fluorescent - LED

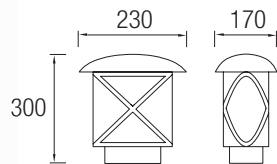

CROSS

10-9295-18-M3 ■

E-27 max. 100W / max. L=170mm
Halogen - Fluorescent - LED

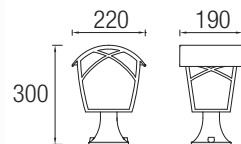

ALBA

10-9350-18-AA ■

E-27 max. 100W / max. L=160mm
Halogen - Fluorescent - LED



2 juegos de cristales incluidos (rústico ámbar + transparente satinado). / 2 sets of glasses included (rustic amber + transparent satin). / 2 jeux de verres fournis (rustique ambre + transparent satiné). / 2 Scheibensätze eingeschl. (rustikal bersteinfarben + transparent satiniert). / 2 set di vetri inclusi (rustico ambr + trasparente satinato). / 2 jogos de vidros incluidos (rústico ámbar + transparente acetinado). / 2 стекла включены в комплект (янтарное и прозрачное сатинированное). / Zawarte 2 komplety szkła (rustykalny bursztynowy + satynowany przezroczysty)



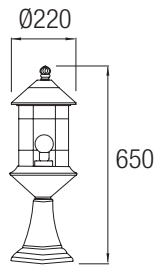

ANDREA NEW

10-9785-18-AA

E-27 max. 100W / max. L=180mm
Halogen - Fluorescent - LED



IP
23



GLA
BU
DIF

IP+



6



P.
593



P.
613



P.
729

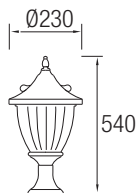

GALATEA

10-9151-18-E7

E-27 max. 100W / max. L=167mm
Halogen - Fluorescent - LED



IP
23

850°C



GLA
DIF

IP+



4



P.
593



P.
613



P.
728





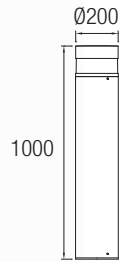

NEWTON

55-9550-34-M2



55-9550-Z5-M2



E-27 max. 100W / max. L=165mm Ø=55mm
Halogen - Fluorescent - LED

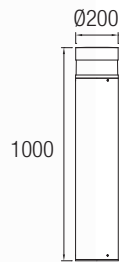
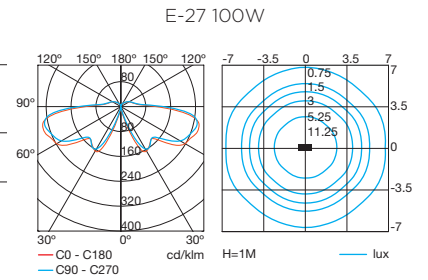

NEWTON

55-9551-34-M2



55-9551-Z5-M2



G12 35W HID 230V

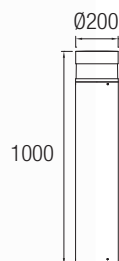
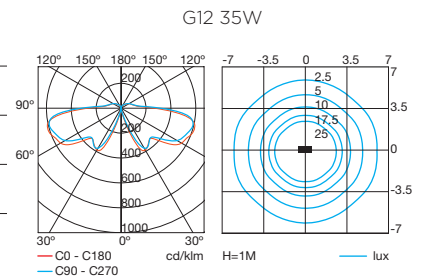

NEWTON

55-9552-34-M2



55-9552-Z5-M2



G12 70W HID 230V

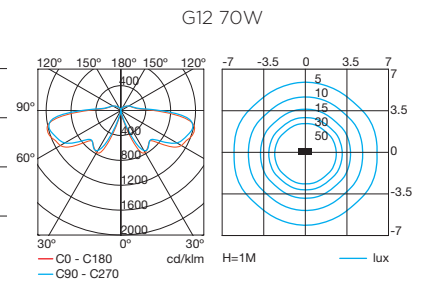



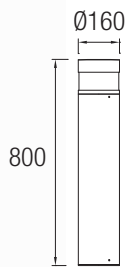

NEWTON

55-9504-34-M2 ■

55-9504-Z5-M2 ■

E-27 max. 60W / max. L=155mm Ø=55mm
Halogen - Fluorescent - LED

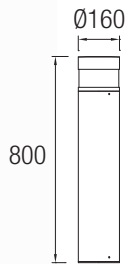
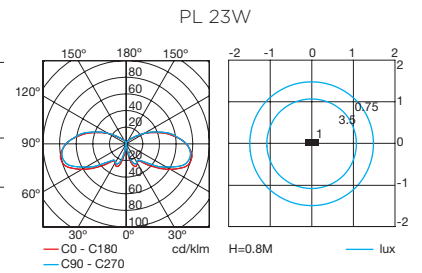

NEWTON

55-9505-34-M2 ■

55-9505-Z5-M2 ■

G8.5 35W HID 230V

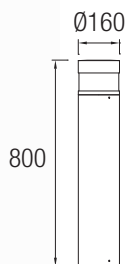
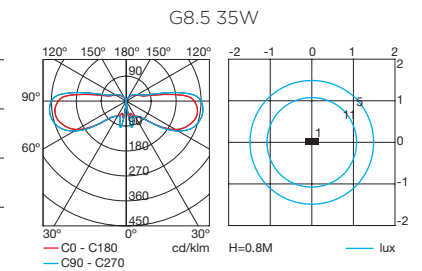

NEWTON

55-9506-34-M2 ■

55-9506-Z5-M2 ■

G8.5 70W HID 230V

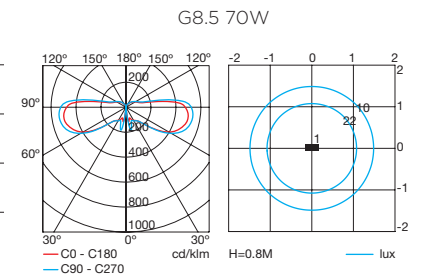



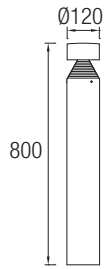
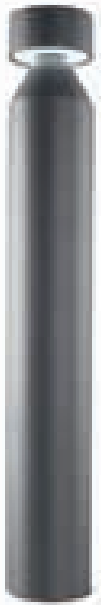

CILIN

55-9706-Z5-CD

9 LED CREE 100-240V 9W 963lm^(N)
Warm white 3000K



EAGLE RISE

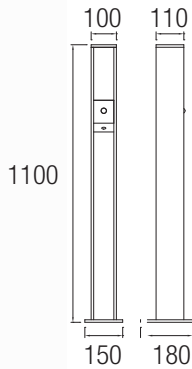
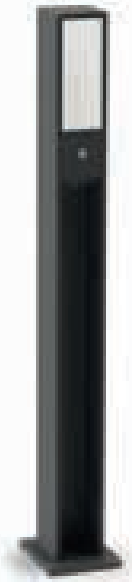

TWO-LIGHT NEW

55-9775-Z5-CD

E-27 max.23W / L= 180mm
+
LED 230V 1W
Warm white 3000K



EAGLE RISE



SENSOR PIR. / PIR SENSOR / CAPTEUR PIR / PIR-SENSOR
(BEWEGUNGSMELDER). / SENSORE PIR. / SENSOR PIR. /
ИНФРАКРАСНЫЙ ДАТЧИК ДВИЖЕНИЯ / CZUJNIK PIR.



Doble iluminación: LED de señalización y E-27 mediante sensor.
Dual illumination: indicator LED and E-27 via sensor.
Double éclairage : LED de signalisation et E-27 par capteur.
Doppelte Beleuchtung: LED zur Signalisierung und E-27 mittels Sensor.
Doppia illuminazione: LED di segnalazione ed E-27 tramite sensore.
Dupla iluminação: LED de sinalização e E-27 através de sensor.
Двойное освещение: сигнальный светодиод и сенсорная лампа E-27
Podwójne oświetlenie: sygnalizacyjna LED i E-27 za pośrednictwem czujnika.

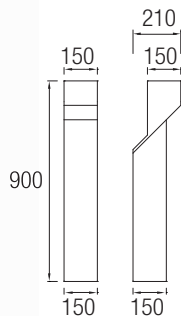

QUADRA

55-9374-34-T2

2 x GX24d-3 26W Fluorescent 230V

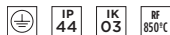

BAG



2 x Gx24d-3 26W

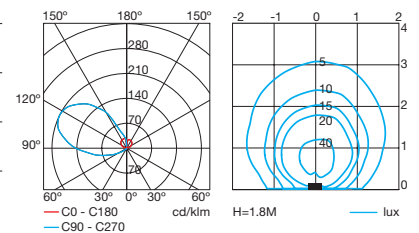



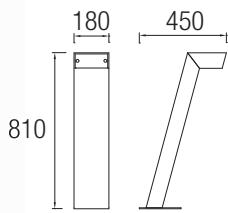

TORCH

55-9459-Z5-M3 ■

2 x E-27 max. 18W / max. L=150mm Ø=50mm
Fluorescent - LED



PL 18W

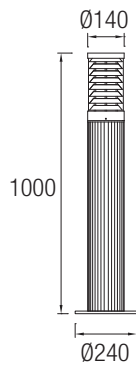
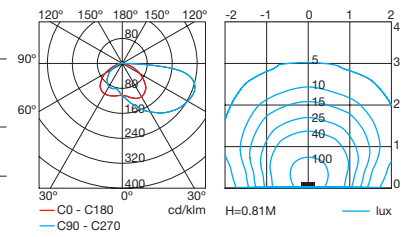

TEMIS

55-9479-34-M2 ■

E-27 max. 100W / max. L=160mm Ø=55mm
Halogen - Fluorescent - LED



PL 30W

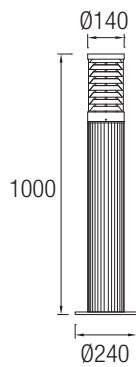
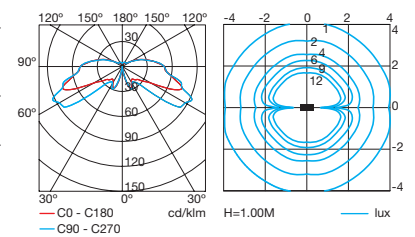

TEMIS

55-9530-34-M2 ■

G12 70W HID 230V

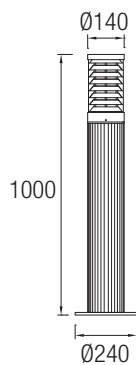

TEMIS

55-9575-34-M2 ■

G12 35W HID 230V





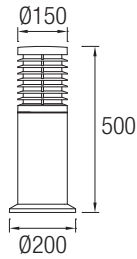

NOTT

55-9655-05-CD

E-27 max. 23W / max. L=190mm
Fluorescent - LED

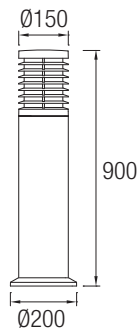
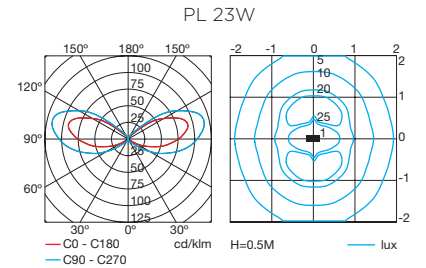
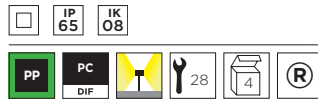

NOTT

55-9656-05-CD

E-27 max. 23W / max. L=190mm
Fluorescent - LED

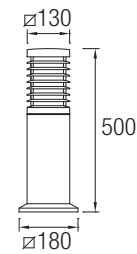
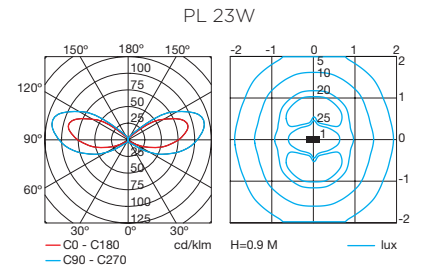
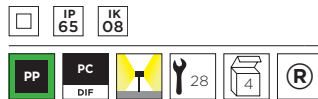

NOTT

55-9657-05-CD

E-27 max. 23W / max. L=190mm
Fluorescent - LED

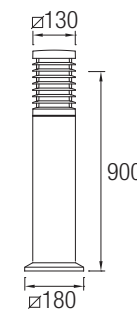
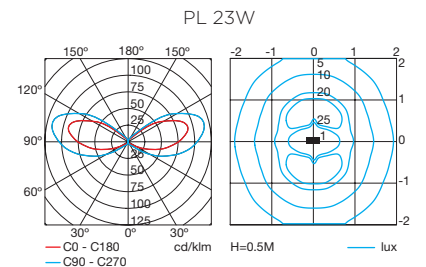
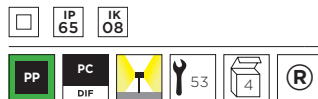

NOTT

55-9658-05-CD

E-27 max. 23W / max. L=190mm
Fluorescent - LED

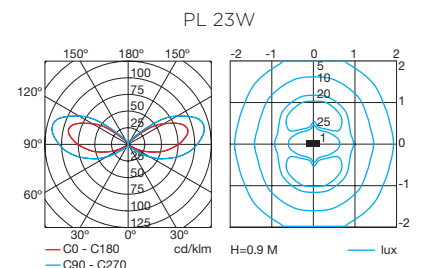
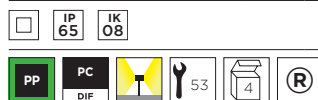



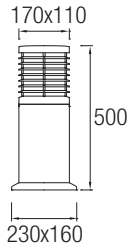

NOTT

55-9357-34-M3 ■

55-9357-Z5-M3 ■

E-27 max. 30W / max. L=190mm
Halogen - Fluorescent - LED

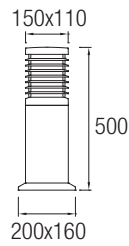
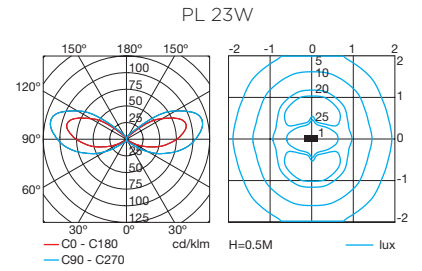
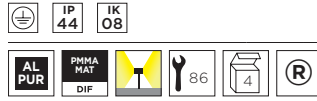

NOTT

55-9358-34-M3 ■

55-9358-Z5-M3 ■

E-27 max. 30W / max. L=190mm
Halogen - Fluorescent - LED

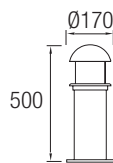
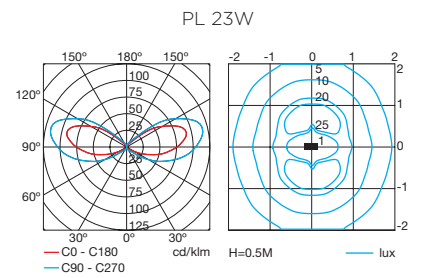
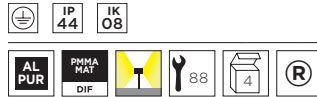

BALIZAS

55-9335-Z5-M3 ■

E-27 max. 100W / max. L=140mm Ø=55mm
Halogen - Fluorescent - LED

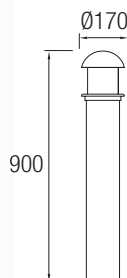
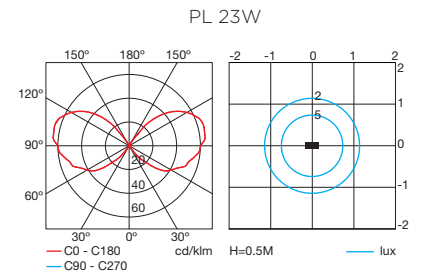

BALIZAS

55-9336-Z5-M3 ■

E-27 max. 100W / max. L=140mm Ø=55mm
Halogen - Fluorescent - LED

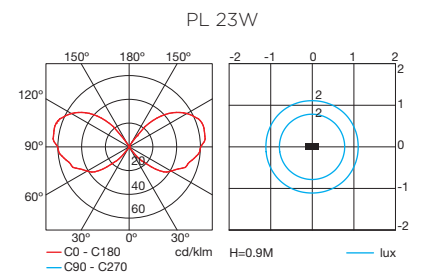



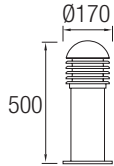

BALIZAS

55-9319-34-M3 ■

55-9319-Z5-M3 ■

E-27 max. 100W / max. L=140mm Ø=55mm
Halogen - Fluorescent - LED

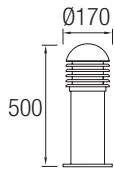
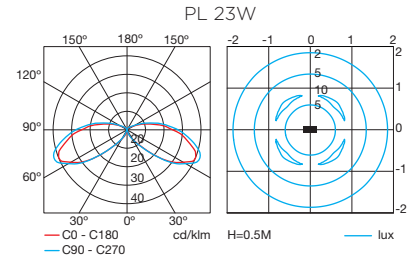

BALIZAS

55-9342-34-M3 ■

55-9342-Z5-M3 ■

G12 70W HID 230V

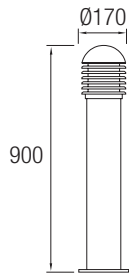
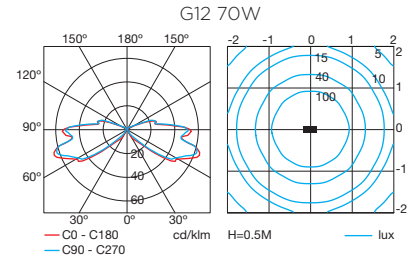

BALIZAS

55-9320-34-M3 ■

55-9320-Z5-M3 ■

E-27 max. 100W / max. L=140mm Ø=55mm
Halogen - Fluorescent - LED

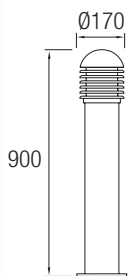
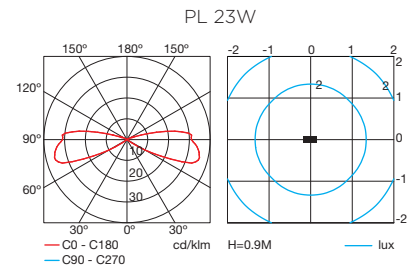

BALIZAS

55-9343-34-M3 ■

55-9343-Z5-M3 ■

G12 70W HID 230V

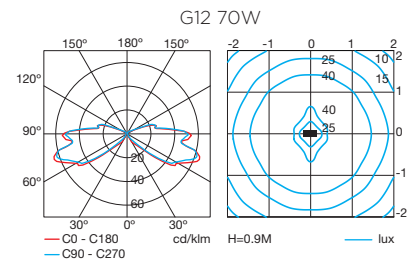



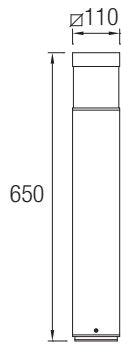

CUBASE

55-9690-34-M2 ■

4 LED CREE 100-240V 9W 728lm^(N)
Warm white 3000K

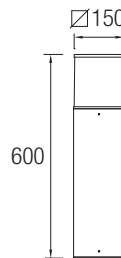

CUBIK

55-9488-34-M3 ■

55-9488-Z5-M3 ■

E-27 max. 60W / max. L=180mm
Halogen - Fluorescent - LED



PL 13W

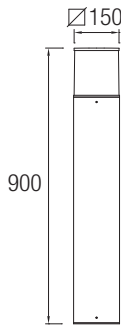
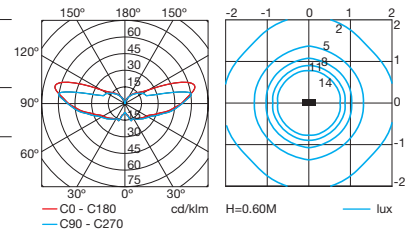

CUBIK

55-9549-34-M3 ■

55-9549-Z5-M3 ■

E-27 max. 60W / max. L=180mm
Halogen - Fluorescent - LED



PL 13W

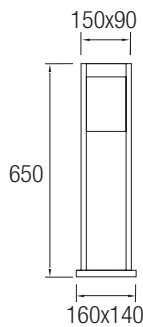
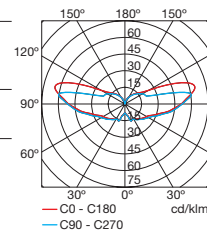

HEBE

55-9238-34-M3 ■

E-27 max. 100W / max. L=167mm Ø=51mm
Halogen - Fluorescent - LED



PL 30W

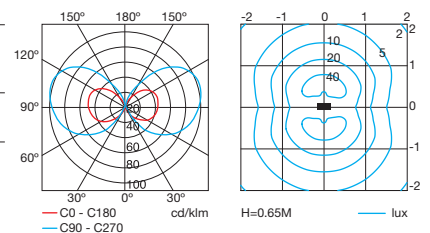



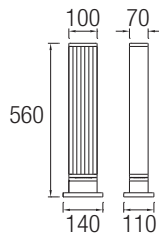
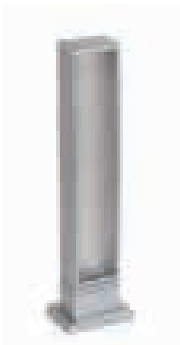

TINA

55-9581-34-M3 ■

2G11 36W 230V

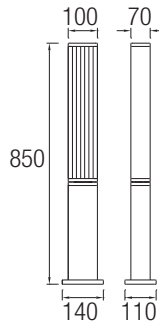
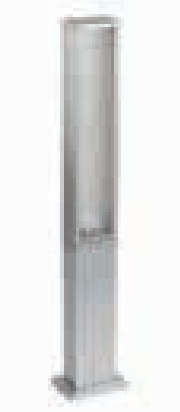
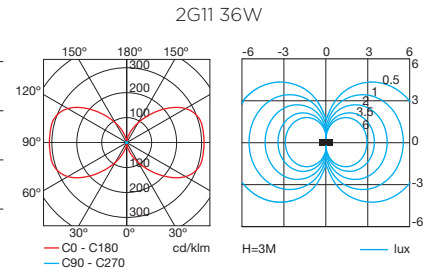
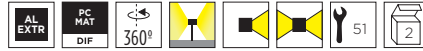

TINA

55-9582-34-M3 ■

2G11 36W 230V

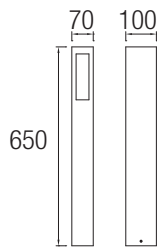
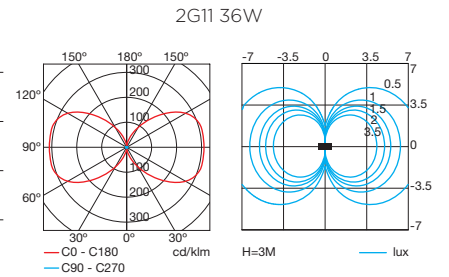
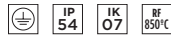

WAY NEW

55-9759-Z5-T2 ■

E-27 max. 60W / max. L=180mm
Halogen - Fluorescent

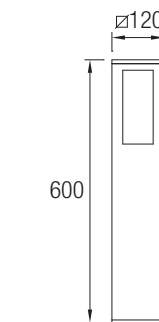

WAY

55-9682-Z5-37 ■

GU-10 max. 50W / max. L=80mm
Halogen - Fluorescent - LED

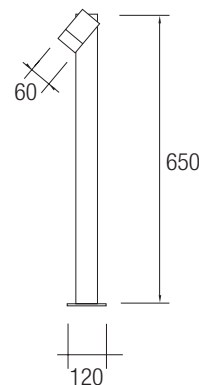
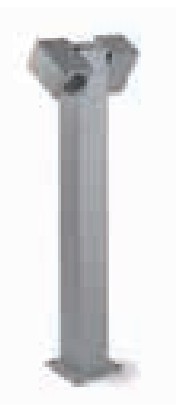
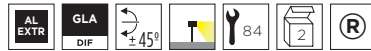

ICARO

55-9190-34-37 ■

2 x GU-10 max. 50W / max. L=75mm
Halogen - Fluorescent - LED



2 x OSRAM 50W

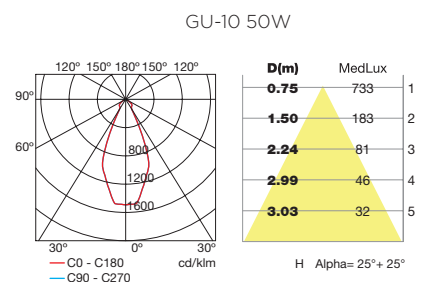



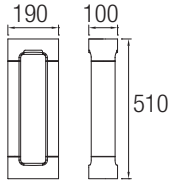

MÜLLER

10-9556-Z5-M3

GX53 max. 13W
Fluorescent - LED

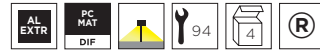

GX53 13W

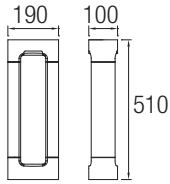
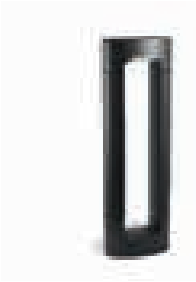
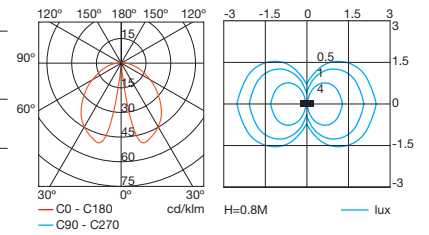

MÜLLER

10-9557-Z5-M3

LED BRIDGELUX 100-240V 10W 1050lm^(N)
Neutral white 4000K



LED 10W

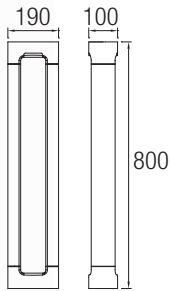
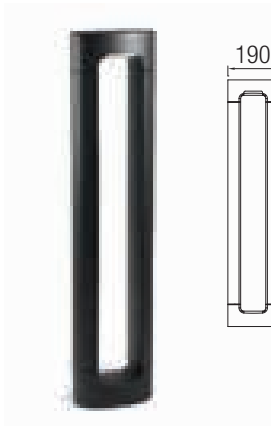
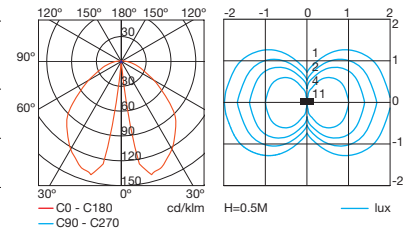

MÜLLER

55-9556-Z5-M3

GX53 max. 13W
Fluorescent - LED



GX53 13W

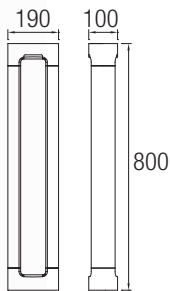
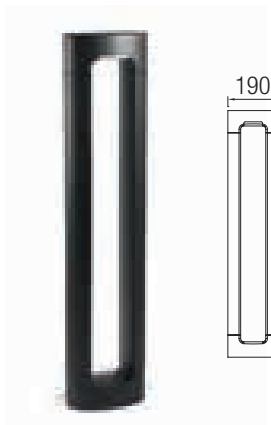
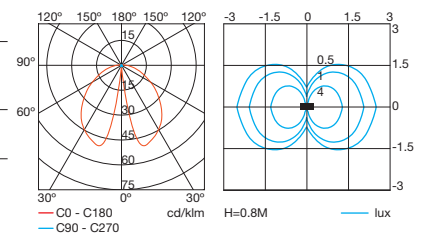

MÜLLER

55-9557-Z5-M3

LED BRIDGELUX 100-240V 10W 1050lm^(N)
Neutral white 4000K



LED 10W

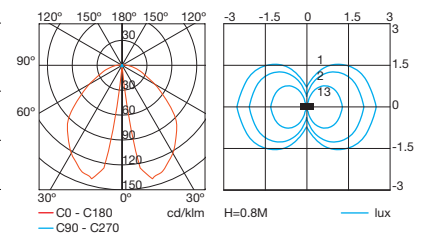





PILE 10-9555-34-M3

4 LED CREE 100-240V 4W 488lm^(N)
Neutral white 4000K



EAGLE RISE

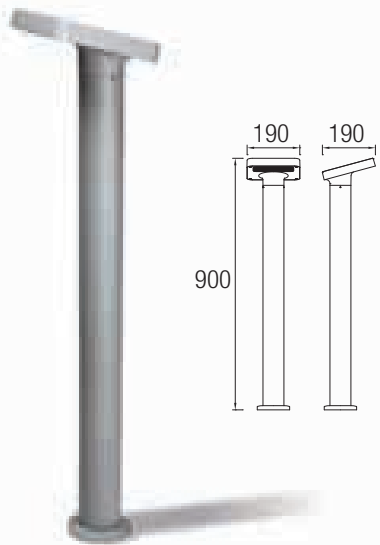
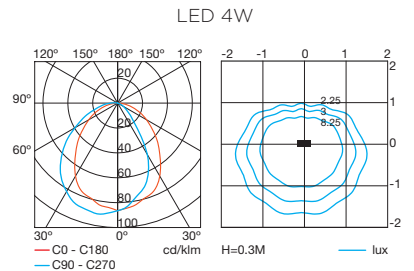
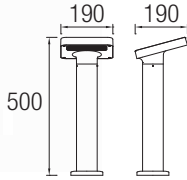

PILE 55-9555-34-M3

8 LED CREE 100-240V 8W 976lm^(N)
Neutral white 4000K



EAGLE RISE

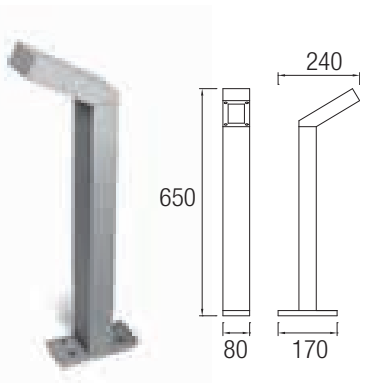
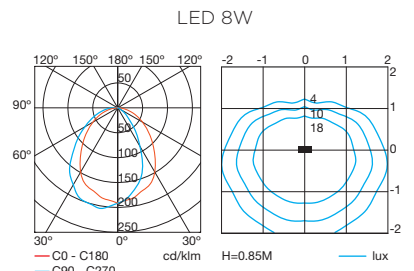
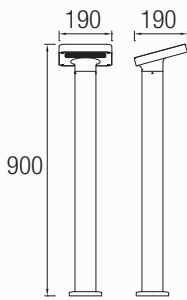

WALKER 55-9595-34-M3 (S)

3 LED CREE 100-240V 6,5W 621lm^(N)
Neutral white 4000K

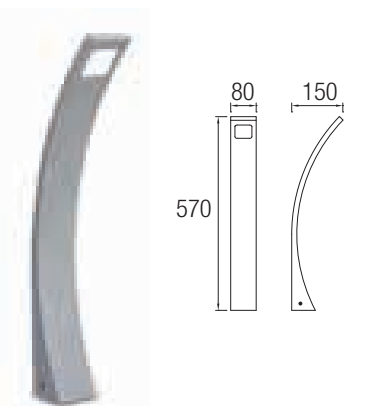
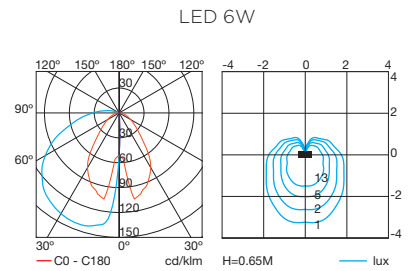
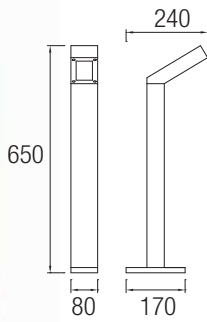

SHARPE 55-9602-34-M1

3 LED CREE 100-240V 3W 366lm^(N)
Neutral white 4000K



EAGLE RISE

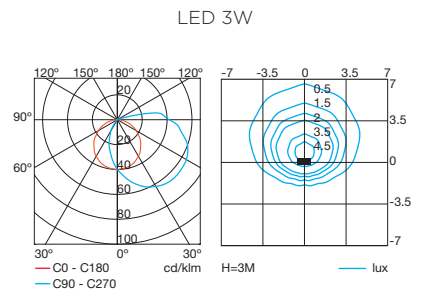
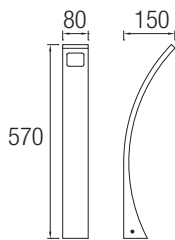



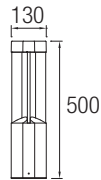
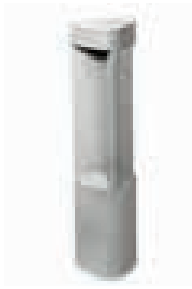

TAUBE

10-9607-34-M1

3 LED CREE 100-240V 6,5W 62lm^(N)
Neutral white 4000K



IP 44



EAGLE RISE

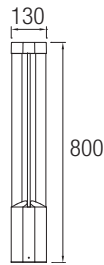
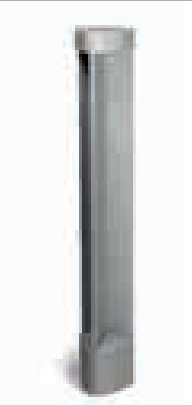
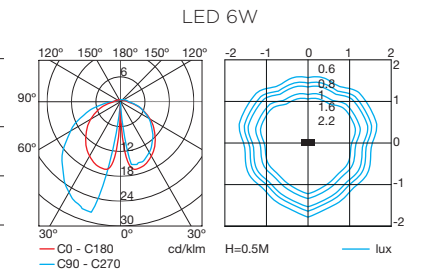

TAUBE

55-9607-34-M1

3 LED CREE 100-240V 6,5W 62lm^(N)
Neutral white 4000K



IP 44



EAGLE RISE

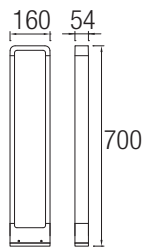
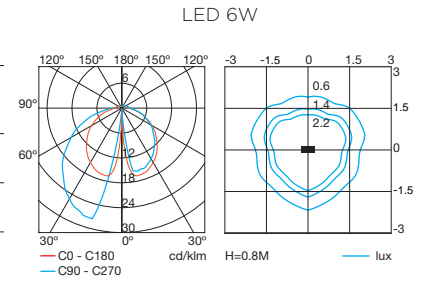

BEUTLER NEW

55-9760-Z5-37

LED BRIDGELUX 100-240V 4,25W 400lm^(N)
Neutral white 4000K



IP 54



SELF

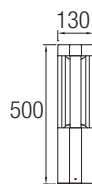
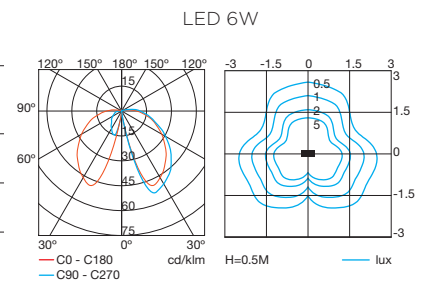

HELION

55-9720-Z5-M1

LED EDISON 100-240V 6W 440lm^(N)
Warm white 3000K



IP 54



EAGLE RISE

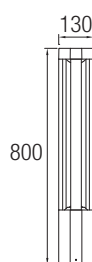
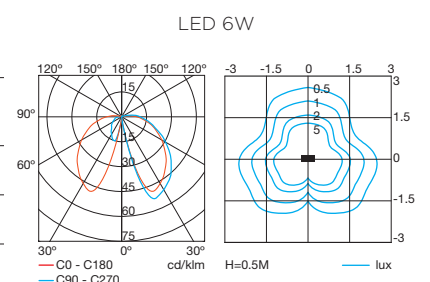

HELION

55-9721-Z5-M1

LED EDISON 100-240V 6W 440lm^(N)
Warm white 3000K



IP 54



EAGLE RISE





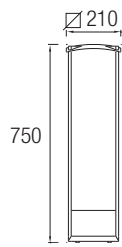

MARK

55-9390-14-M1

PC OPAL **NEW**

55-9390-Z5-M3

PC MAT

2G11 55W 230V



IP
44



BAG



AL
PUR



PC
MAT



PC
OPAL



95



2



P.
581



P.
609



P.
607



P.
679

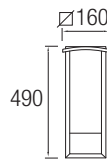
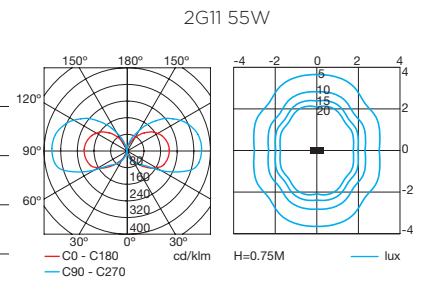

MARK

55-9298-Z5-M3

■

2G11 24W 230V



IP
44



BAG



AL
PUR



PC
MAT



75



4



P.
581



P.
609



P.
607



P.
679

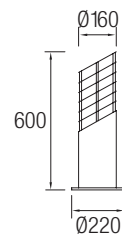
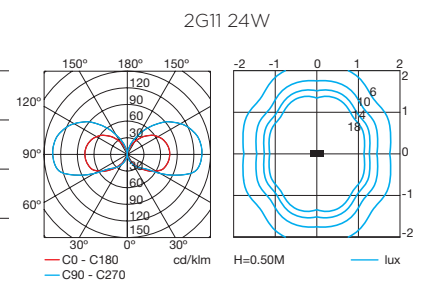

BALIZAS

55-8956-05-M1

■ (S)

55-8956-34-M1

■ (S)

E-27 max. 100W / max. L=167mm Ø=51mm

Halogen - Fluorescent - LED



IP
44



AL
INJ



PC
OPAL



40



4



P.
675

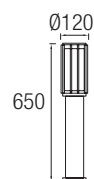

SIMS

55-9717-34-M1

■

E-27 max. 30W / max. L=200mm

Fluorescent - LED



IP
44



AL
INJ



PC
OPAL



18



4



P.
571



P.
607



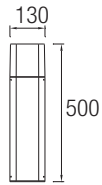

MANDELA

55-9605-Z5-M1 ■

E-27 max. 40W / max. L=150mm
Halogen - Fluorescent - LED



PL 18W

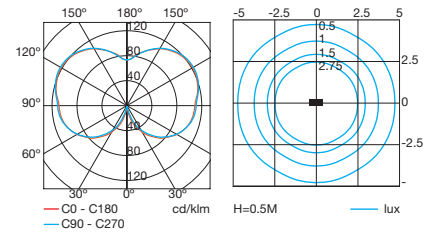

MANDELA

55-9606-Z5-M1 ■

E-27 max. 40W / max. L=150mm
Halogen - Fluorescent - LED



PL 18W

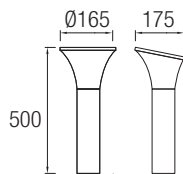
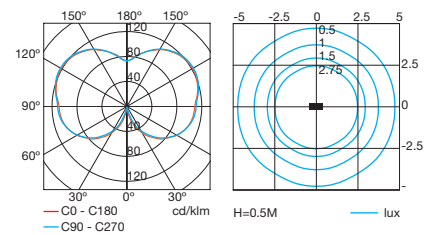

SUZUKI

55-9715-Z5-M1 ■

E-27 max. 18W / max. L=150mm Ø=53mm
Fluorescent - LED

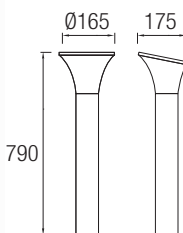
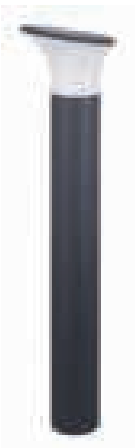

SUZUKI

55-9716-Z5-M1 ■

E-27 max. 18W / max. L=150mm Ø=53mm
Fluorescent - LED





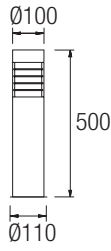

PRIAP NEW

55-9239-CA-M2

E-27 max. 23W / max. L=152mm Ø=50mm
Fluorescent - LED



PL 23W

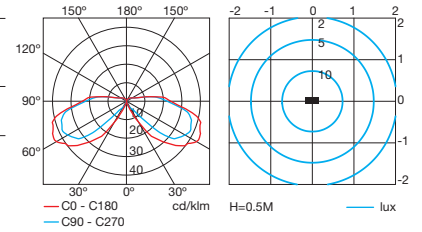

PRIAP NEW

55-9440-CA-M2

E-27 max. 23W / max. L=152mm Ø=50mm
Fluorescent - LED



PL 23W

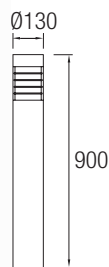
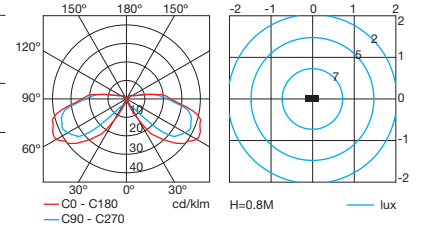

PRIAP

55-9317-Y4-M2

E-27 max. 23W / max. L=152mm Ø=50mm
Fluorescent - LED



PL 23W

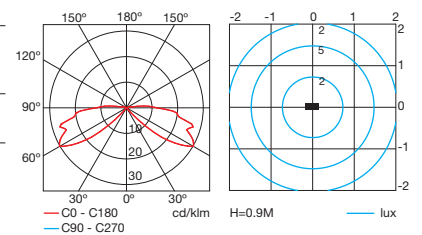



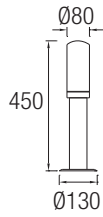
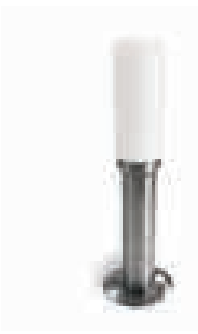

EDWARDS

10-9613-CA-B8 ■

E-27 max. 75W / max. L=160mm Ø=50mm
Halogen - Fluorescent - LED

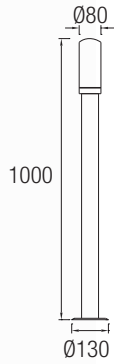
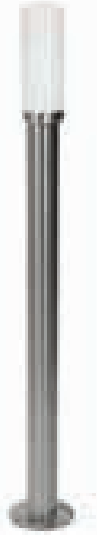

EDWARDS

55-9613-CA-B8 ■

E-27 max. 75W / max. L=160mm Ø=50mm
Halogen - Fluorescent - LED

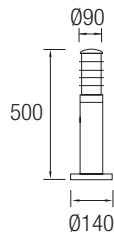
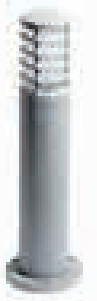

ALEXANDRIA

10-9329-18-B8 ■ (S)

10-9329-34-B8 ■

E-27 max. 100W / max. L=167mm Ø=51mm
Halogen - Fluorescent - LED

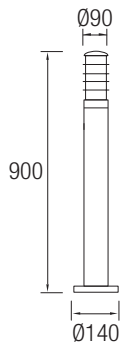
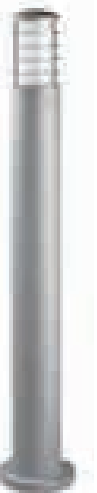

ALEXANDRIA

55-9329-18-B8 ■ (S)

55-9329-34-B8 ■

E-27 max. 100W / max. L=167mm Ø=51mm
Halogen - Fluorescent - LED





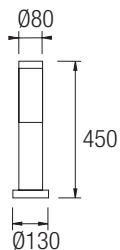
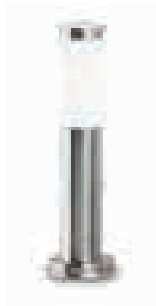

ELECTRA

10-8790-Y4-M1 ■

E-27 max. 23W / max. L=167mm Ø=55mm
Fluorescent - LED

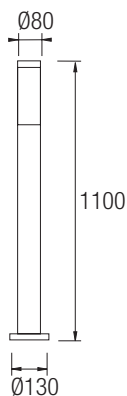
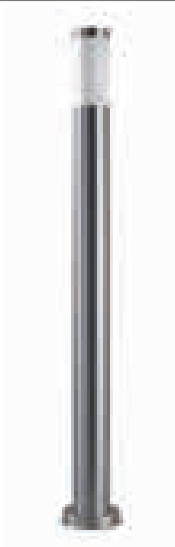

ELECTRA

55-8790-Y4-M1 ■

E-27 max. 23W / max. L=167mm Ø=55mm
Fluorescent - LED



55-8791-Y4-Y4 ■

Kit reflector / Reflector kit / Kit réflecteur / Reflektor-Kit / Kit riflettore /
Kit refletor / Комплект отражателей / Zestaw odbłyśnika / **10-8790,**
55-8790

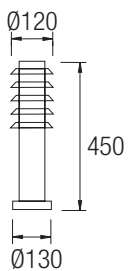

ELECTRA

10-9333-J6-M1 ■

E-27 max. 23W / max. L=167mm Ø=51mm
Fluorescent - LED



ELECTRA

55-9333-J6-M1 ■

E-27 max. 23W / max. L=167mm Ø=51mm
Fluorescent - LED





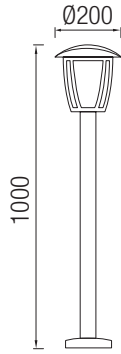

EVANS

55-9624-18-M3 ■ (S)

E-27 max. 40W / max. L=130mm
Halogen - Fluorescent - LED

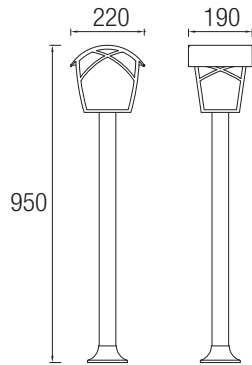
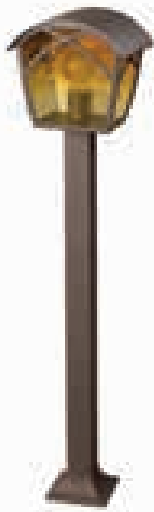

ALBA

55-9350-18-AA ■

E-27 max.100W / max. L=160mm
Halogen - Fluorescent - LED

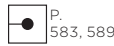

2 juegos de cristales incluidos (rústico ámbar + transparente satinado). / 2 sets of glasses included (rustic amber + transparent satin). / 2 jeux de verres fournis (rustique ambre + transparent satiné). / 2 Scheibensätze eingeschl. (rustikal bersteinfarben + transparent satiniert). / 2 giochi di vetri inclusi (rustico ambretta + trasparente satinato). / 2 jogos de vidros incluídos (rústico âmbar + transparente acetinado). / 2 стекла включены в комплект (янтарное и прозрачное сатинованное). / Zawarte 2 komplety szkła (rustykalny bursztynowy + satynowany przezroczysty)

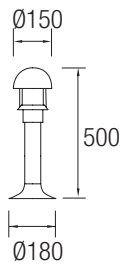

MIDAS

10-9183-18-B8 ■

E-27 max.100W / max. L=128mm Ø=45mm
Halogen - Fluorescent - LED

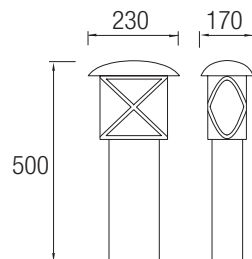

CROSS

55-9295-18-M3 ■

E-27 max.100W / max. L=170mm
Halogen - Fluorescent - LED





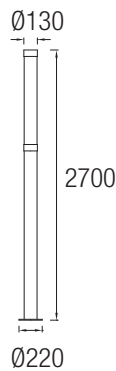
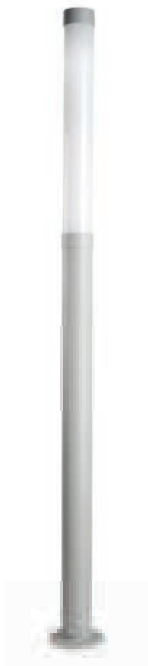

LYON

55-9670-34-M1

2 x T5 21/39W 230V



Sodio de alta presión y halogenuros metálicos.
High pressure sodium and metal halide.
Sodium haute pression et iodures métalliques.
Natriumdampf - Hochdrucklampen und Halogen - Metalldampfampfen.
Sodio ad alta pressione e alogenuri metallici.
Sódio de alta pressão e iodetos metálicos.
Натриевые лампы высокого давления и металлогалогеновые лампы.
Soda wysokociśnieniowa i metalohalogeny.

2 x E-40 150W

TEMIS

60-9294-34-M2

2 x E-40 150W 230V



60-9294+55-9293

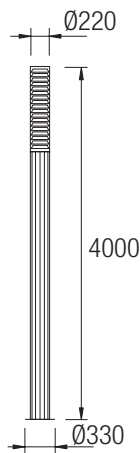
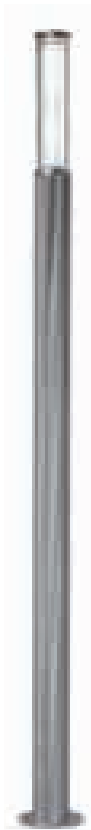
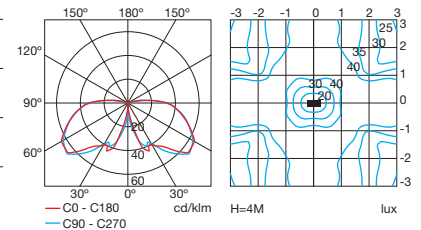

60-9294
+
55-9293

TEMIS

55-9293-34-34

Columna de 4m de altura./ 3.5m high column./ Mât de 4 m de haut./ Säule, 4 m hoch./ Colonna di 4m di altezza./ Coluna de 4 m de altura./ Колонна высотой 4 м./ Słup o wysokości 4m.



Reflectores anticontaminación lumínica.
Anti light pollution reflectors.
Réflecteurs anti-pollution lumineuse.
Reflektore für eine umweltfreundliche Beleuchtung
Riflettori anti-contaminazione luminica.
Reflectores que evitam a poluição luminosa.
Отражатели для предотвращения светового загрязнения
Odbłyśniki zapobiegające zjawisku "light pollution"

Kit de instalación incluido.
Installation kit included.
Kit d'installation compris.
Einbaukit inklusive.
Kit installazione incluso.
Kit de instalação incluído.
Прилагается набор для установки
Zestaw montażowy w komplecie



Superficie estriada para evitar el pegado de adhesivos.
Slotted surface to prevent sticking of adhesives.
Surface striée pour éviter le collage d'adhésifs.
Gestreckte Oberflächen, um das Ankleben von Adhäsivmaterial zu vermeiden
Superficie striata per evitare l'attacco degli adesivi.
Superficie estriada para evitar a colagem de adesivos.
Рифленая поверхность для предотвращения размещения наклеек.
Powierzchnia szczelinowana uniemożliwiająca przyklejanie

Certificado CE para la instalación en espacios públicos.
CE Certificate for installation in public places.
Certificat CE pour l'installation dans les espaces publics.
CE-Zertifikat für die Installation an öffentlichen Bereichen.
Certificato CE per la installazione in spazi pubblici.
Certificado CE para instalação em espaços públicos.
Сертификат CE для установки в общественных местах.
Posiada certyfikat CE na montaż w miejscach publicznych.

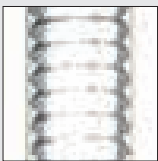

Reflectores anticontaminación luminica.
Anti light pollution reflectors.
Réflecteurs anti-pollution lumineuse.
Reflektore für eine umweltfreundliche Beleuchtung
Riflettori anti-contaminazione luminica.
Reflectores que evitam a poluição luminosa.
Отражатели для предотвращения светового загрязнения
Odbłyśniki zapobiegające zjawisku "light pollution"



Kit de instalación incluido.
Installation kit included.
Kit d'installation compris.
Einbaukit inklusive.
Kit installazione incluso.
Kit de instalação incluido.
Прилагается набор для установки
Zestaw montażowy w komplecie

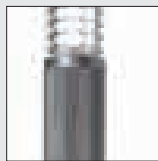

Superficie estriada para evitar el pegado de adhesivos.
Slotted surface to prevent sticking of adhesives.
Surface striée pour éviter le collage d'adhésifs.
Gestreckte Oberflächen, um das Ankleben von Adhäsivmaterial zu vermeiden
Superficie striata per evitare l'attacco degli adesivi.
Superficie estriada para evitar a colagem de adesivos.
Рифленая поверхность для предотвращения размещения наклеек.
Powierzchnia szczelinowana uniemożliwiająca przyklejanie

Certificado **CE** para la instalación en espacios públicos.
CE Certificate for installation in public places.
Certificat **CE** pour l'installation dans les espaces publics.
CE-Zertifikat für die Installation an öffentlichen Bereichen.
Certificato **CE** per la installazione in spazi pubblici.
Certificado **CE** para instalação em espaços públicos.
Сертификат **CE** для установки в общественных местах.
Posiada certyfikat **CE** na montaż w miejscach publicznych.

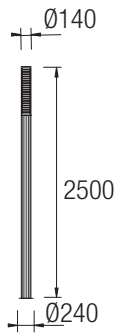
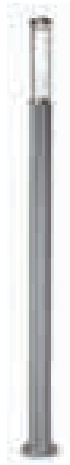

TEMIS

55-9431-34-M2

2 x GX24q-4 26-32-42W 230V

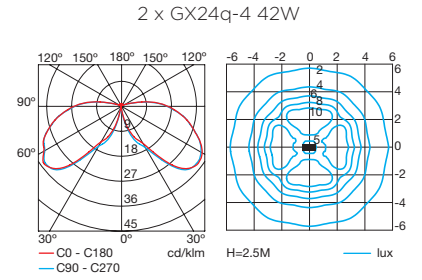

TEMIS

71-9515-52-52

Reflector direccional para / Directional reflector for / Réflecteur directionnel pour / Reflektor für / Riflettore direzionale per / Refletor direccional para / Направленный отражатель для / Odblyśnik kierunkowy dla / **55-9431**

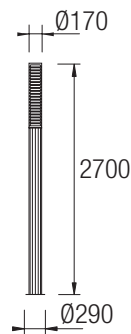
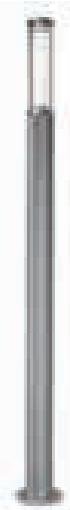
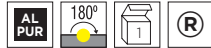

TEMIS

55-9268-34-M2

4 x 2G11 55W 230V

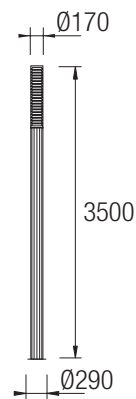
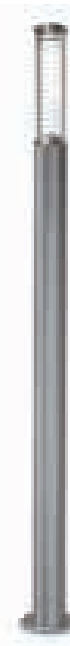
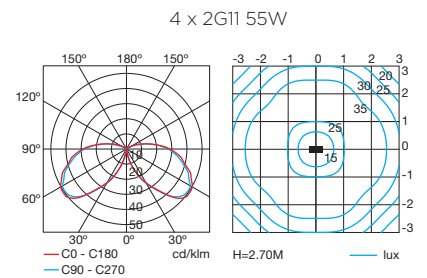

TEMIS

55-9269-34-M2

4 x 2G11 55W 230V

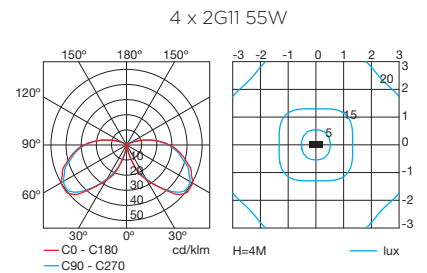

TEMIS

71-9514-52-52

Reflector direccional para / Directional reflector for / Réflecteur directionnel pour / Reflektor für / Riflettore direzionale per / Refletor direccional para / Направленный отражатель для / Odblyśnik kierunkowy dla / **55-9268, 55-9269**

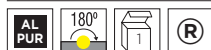



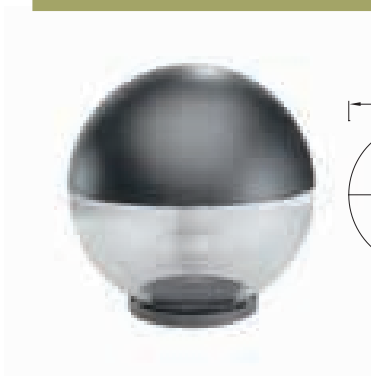

HEADS

60-9482-Z5-M2

E-27 max. 100W
Halogen - Fluorescent - LED



PL 30W

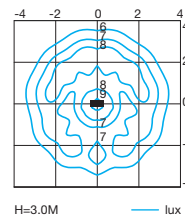

HEADS

71-9508-00-00

E-27 70W 230V

Kit de sodio de alta presión y halogenuros metálicos de 70W para / 70W high pressure sodium and metal halide kit for / Kit de sodium haute pression et iodures métalliques de 70 W pour / Kit für Natriumdampf - Hochdrucklampen und Halogen - Metaldampflampen. mit 70 W für / Kit di sodio ad alta pressione e alogenuri metallici di 70W per / Kit de sódio de alta pressão e iodetos metálicos de 70 W para / Комплект под натриевые лампы высокого давления и металлогалогеновые лампы 70Вт для / Soda wysokociśnieniowa i metalohalogenowe 70W dla **60-9482**



HIT 70W

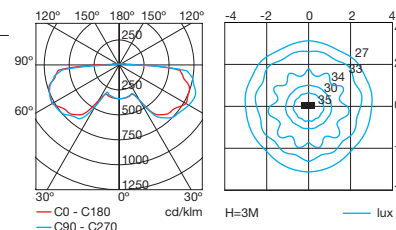

POMPEYA

71-9291-34-34

Soporte para instalación en poste de diámetro 60mm para usar con los cabezales Pompeya: / Supporting bracket for use with 60mm diameter post installation. To be used with Pompeya heads: / Support à installer sur un mât de 60 mm de diamètre à utiliser avec les têtes Pompeya: / Halterung an Masten mit 60 mm Durchmesser zur Verwendung mit den Köpfen Pompeya: / Supporto per installazione su palo di diametro 60mm da utilizzare con testata Pompeya: / Suporte para instalação em poste com diâmetro de 60 mm para usar com as cabeças Pompeya: / Крепление для установки на столбе диаметром 60 мм для использования головок Помпея: / Wspornik dla instalacji na słupku o średnicy 60mm do użycia z głowicami Pompeya: / **05-9251, 05-9537, 05-9538, 05-9539, 05-9254**



POMPEYA

71-9292-34-34

Soporte para instalación en poste de diámetro 60mm para usar con los cabezales Pompeya: / Supporting bracket for use with 60mm diameter post installation. To be used with Pompeya heads: / Support à installer sur un mât de 60 mm de diamètre à utiliser avec les têtes Pompeya: / Halterung an Masten mit 60 mm Durchmesser zur Verwendung mit den Köpfen Pompeya: / Supporto per installazione su palo di diametro 60mm da utilizzare con testata Pompeya: / Suporte para instalação em poste com diâmetro de 60 mm para usar com as cabeças Pompeya: / Крепление для установки на столбе диаметром 60 мм для использования головок Помпея: / Wspornik dla instalacji na słupku o średnicy 60mm do użycia z głowicami Pompeya: / **05-9251, 05-9537, 05-9538, 05-9539, 05-9254**



55-9305-48-48

Columna de 3,5m de altura./ 3.5m high column./ Mât de 3,5 m de haut./ Säule, 3,5 m hoch./ Colonna di 3,5m di altezza./ Coluna de 3,5 m de altura./ Колонна высотой 3,5 м./ Słup o wysokości 3,5m.



Kit de instalación incluido /
Installation kit included /
Kit d'installation compris /
Einbautkit inklusive / Kit installazione incluso /
Kit de instalação incluído /
Прилагается набор для установки /
Zestaw montażowy w komplecie

Sustitución de la lámpara sin herramientas.
Lamps can be changed without any tools.
Remplacement de la lampe sans outils.
Leuchtmittelersetzungs ohne Werkzeuge.

Sostituzione della lampadina senza attrezzi.
Substituição de lâmpada sem ferramenta
Ручная замена лампочки.
Żarówka może być wymieniona bez użycia narzędzi



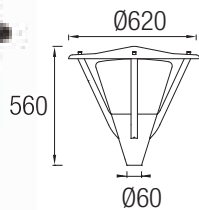

HEADS

60-9376-Z5-M3

E-27 max. 150W
Halogen - Fluorescent - LED



E-27 100W

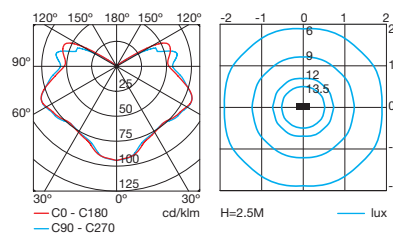

HEADS

71-9399-05-05



Accesorio anticontaminación luminica para / Anti light pollution accessory for / Accessoire antipollution lumineuse pour / Zubehöre gegen Lichtverschmutzung für / Accessorio anti-inquinamento luminico per / Acessório antipoluição luminosa para / Принадлежность против светового загрязнения для / Akcesorium przeciw zanieczyszczeniu świetlnemu dla / 60-9376



HEADS

71-9442-00-00



E-27 70W 230V

Kit de sodio de alta presión y halogenuros metálicos de 70W para / 70W high pressure sodium and metal halide kit for / Kit de sodium haute pression et iodures métalliques de 70 W pour / Kit für Natriumdampf - Hochdrucklampen und Halogen - Metaldampflampen. mit 70 W für / Kit di sodio ad alta pressione e alogenuri metallici di 70W per / Kit de sódio de alta pressão e iodetos metálicos de 70 W para / Комплект под натриевые лампы высокого давления и металлогалогеновые лампы 70Вт для / Soda wysokociśnieniowa i metalohalogen 70W dla / 60-9376

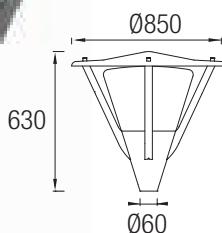

Sodio de alta presión y halogenuros metálicos.
High pressure sodium and metal halide.
Sodium haute pression et iodures métalliques.
Natriumdampf - Hochdrucklampen und Halogen - Metaldampflampen.
Sodio ad alta pressione e alogenuri metallici.
Sódio de alta pressão e iodetos metálicos.
Натриевые лампы высокого давления и металлогалогеновые лампы.
Soda wysokociśnieniowa i metalohalogen.

HEADS

60-9307-Z5-M3

E-40 150W 230V



BAG



60-9307 + 71-9398

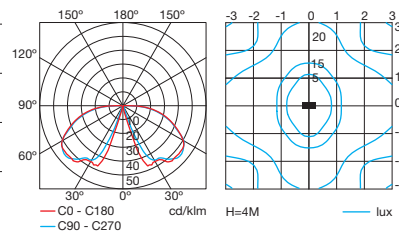

HEADS

71-9398-05-05



Accesorio anticontaminación luminica para / Anti light pollution accessory for / Accessoire antipollution lumineuse pour / Zubehöre gegen Lichtverschmutzung für / Accessorio anti-inquinamento luminico per / Acessório antipoluição luminosa para / Принадлежность против светового загрязнения для / Akcesorium przeciw zanieczyszczeniu świetlnemu dla / 60-9307

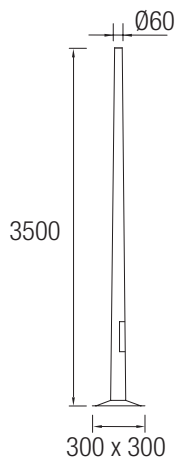

55-9305-48-48

Columna de 3,5m de altura. / 3.5m high column. / Mât de 3,5 m de haut. / Mast 3,5 m hoch. / Colonna di 3,5m di altezza. / Coluna de 3,5 m de altura. / Колонна высотой 3,5 м. / Słup o wysokości 3,5m.



Kit de instalación incluido / Installation kit included / Kit d'installation compris / Einbaukit inklusive / Kit installazione incluso / Kit de instalação incluido / Прилагается набор для установки / Zestaw montażowy w komplecie

Sustitución de la lámpara sin herramientas.
The bulb can be changed without any tools.
Remplacement de la lampe sans outils.
Leuchtmittelerersetzung ohne Werkzeuge.

Sostituzione della lampadina senza attrezzi.
Substituição de lâmpada sem ferramenta
Ручная замена лампочки.
Żarówka może być wymieniona bez użycia narzędzi

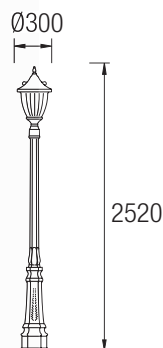
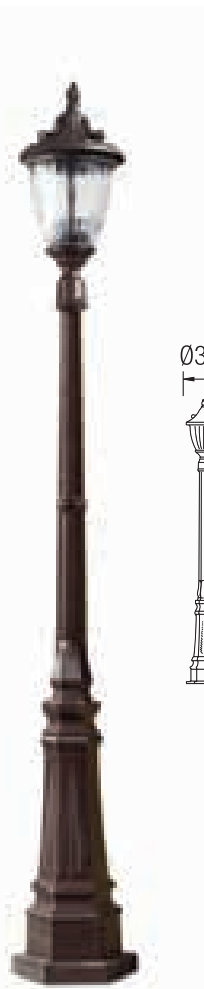

GALATEA

60-9151-18-E7

3 x E-14 max. 60W / max. L=120mm Ø35mm
Halogen - Fluorescent - LED



55-9151-18-18

Columna / Column/ Mât / Säule / Colonna / Coluna / Колонна / Stup



Para farola completa pedir códigos / For a complete lamp post, order both codes. / Pour le réverbère complet, demander les codes / Für eine komplette Mastleuchte bitte die folgenden Artikel - Nr. bestellen / Per il lampione completo ordinare i codici / Para poste de iluminação exterior completo pedir códigos / Для заказа фонаря целиком запрашивайте следующие артикулы / Dla pełnej latarni zamówić kody

60-9151-18-E7 + 55-9151-18-18

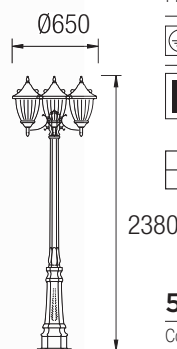

GALATEA

60-9152-18-E7

3 x E-27 max. 100W / max. L=167mm Ø=51mm
Halogen - Fluorescent - LED

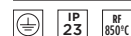

55-9151-18-18

Columna / Column/ Mât / Säule / Colonna / Coluna / Колонна / Stup



Para farola completa pedir códigos / For a complete lamp post, order both codes. / Pour le réverbère complet, demander les codes / Für eine komplette Mastleuchte bitte die folgenden Artikel - Nr. bestellen / Per il lampione completo ordinare i codici / Para poste de iluminação exterior completo pedir códigos / Для заказа фонаря целиком запрашивайте следующие артикулы / Dla pełnej latarni zamówić kody

60-9152-18-E7 + 55-9151-18-18

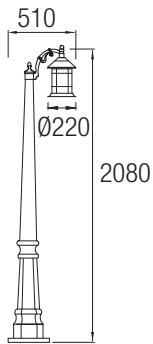

ANDREA

60-9785-18-AA

E-27 max. 100W / max. L=180mm
Halogen - Fluorescent - LED



IP 23

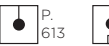

55-9151-18-18

Columna / Column / Mât / Säule / Colonna / Coluna / Колонна / Stup



Para farola completa pedir códigos / For a complete lamp post, order both codes. / Pour le réverbère complet, demander les codes / Für komplette Laterne Art.-Nr. bestellen / Per il lampione completo ordinare i codici / Para poste de iluminação exterior completo pedir códigos / Для заказа фонаря целиком запрашивайте следующие артикулы / Dla pełnej latarni zamówić kody

60-9785-18-AA + 55-9151-18-18

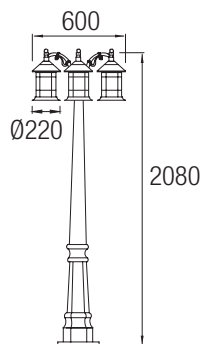

ANDREA

60-9786-18-AA

3 x E-27 max. 100W / max. L=180mm
Halogen - Fluorescent - LED



IP 23



55-9151-18-18

Columna / Column / Mât / Säule / Colonna / Coluna / Колонна / Stup



Para farola completa pedir códigos / For a complete lamp post, order both codes. / Pour le réverbère complet, demander les codes / Für komplette Laterne Art.-Nr. bestellen / Per il lampione completo ordinare i codici / Para poste de iluminação exterior completo pedir códigos / Для заказа фонаря целиком запрашивайте следующие артикулы / Dla pełnej latarni zamówić kody

60-9786-18-AA + 55-9151-18-18

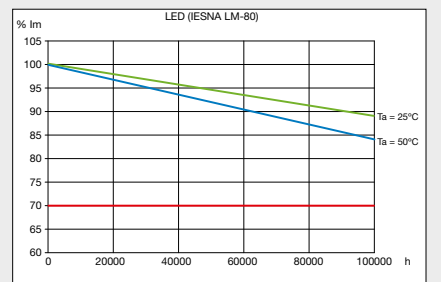
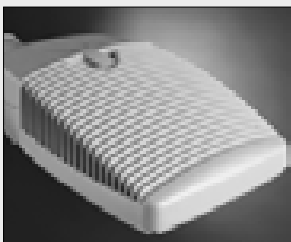

ESENCIAL

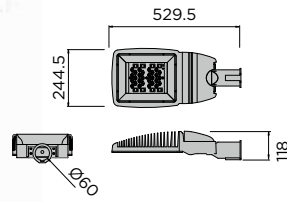

LED 56W
ULOR INST = 0,73%

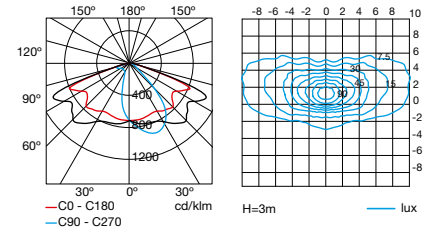

LED OSRAM Neutral white 4000K

30W	16 LED	2.953 lm ^(N)		80-4744-AT-37
45W	20 LED	4.429 lm ^(N)		80-4748-AT-37
45W	20 LED	4.429 lm ^(N)	2N	80-4750-AT-37
45W	20 LED	4.429 lm ^(N)	2N TEMP	80-4749-AT-37
56W	24 LED	5.315 lm ^(N)		80-4752-AT-37
56W	24 LED	5.315 lm ^(N)	2N	80-4754-AT-37
56W	24 LED	5.315 lm ^(N)	2N TEMP	80-4753-AT-37

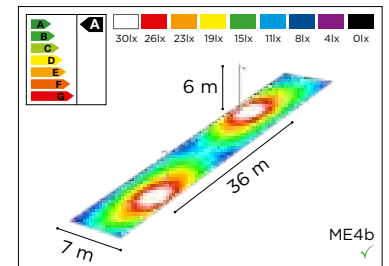
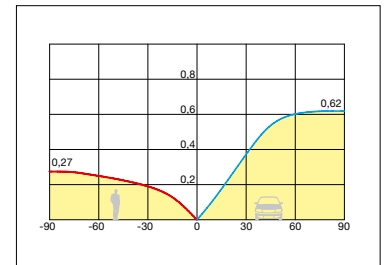

OUTDOOR | URBAN

ESENCIAL SOLAR



NEW

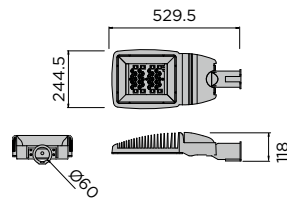

LED 45W
ULOR INST = 0,73%

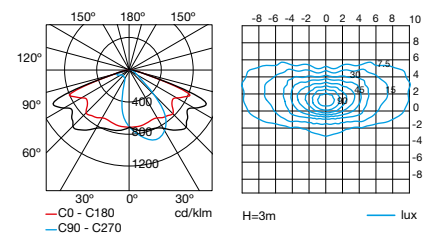

LED OSRAM Neutral white 4000K

30W	20 LED	2.953 lm ^(N)		80-2617-AT-37
45W	20 LED	4.429 lm ^(N)		80-2618-AT-37

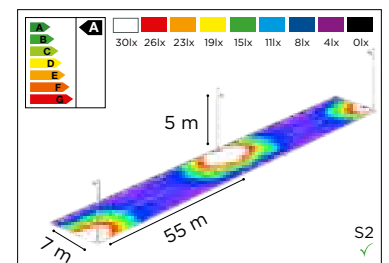
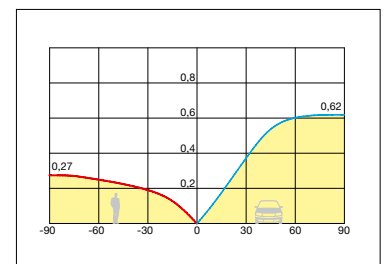



ESENCIAL HP

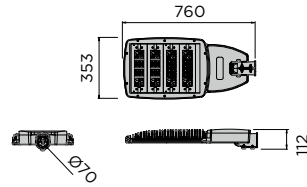

LED 130W
ULOR INST = 0,73%

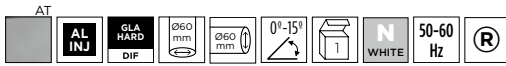
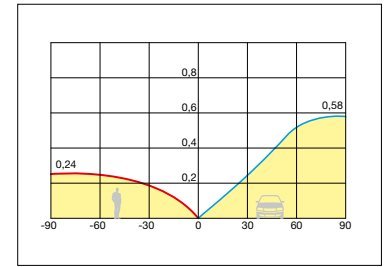
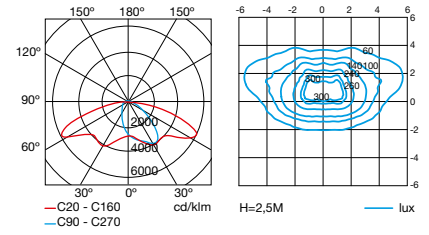

LED OSRAM Neutral white 4000K

80W	40 LED	8.485 lm ^(N)	220-240V CE	80-1767-AT-37
80W	40 LED	8.485 lm ^(N)	120-277V UL	80-3235-AT-37
100W	48 LED	10.606 lm ^(N)	220-240V CE	80-1769-AT-37
100W	48 LED	10.606 lm ^(N)	120-277V UL	80-3236-AT-37
130W	64 LED	13.787 lm ^(N)	220-240V CE	80-1780-AT-37
130W	64 LED	13.787 lm ^(N)	120-277V UL	80-3237-AT-37

NEW

NEW

NEW

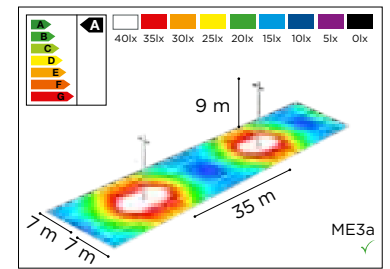

OUTDOOR | URBAN

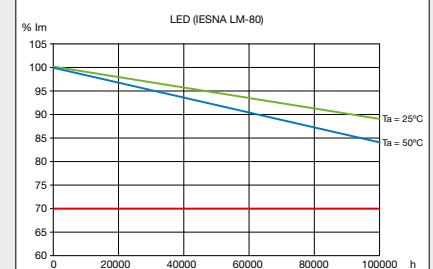
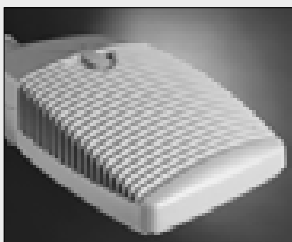



ESENCIAL HP

ESENCIAL

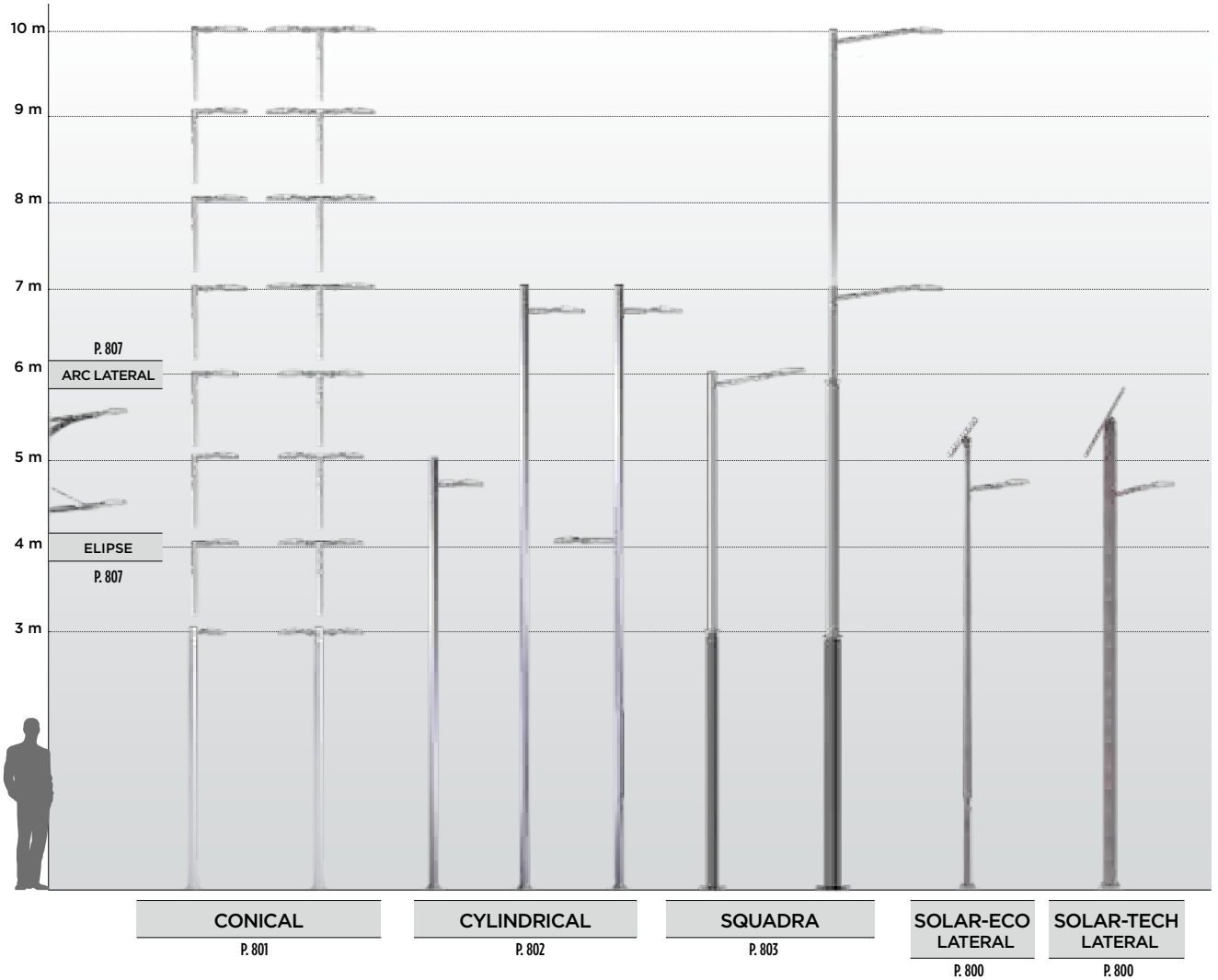

CONICAL
P. 801

CYLINDRICAL
P. 802

SQUADRA
P. 803

SOLAR-ECO
LATERAL
P. 800

SOLAR-TECH
LATERAL
P. 800



ESENCIAL HP

CONICAL	10m	81-4538-AV-AV	71-4541-48-48	71-4525-48-48	✓	71-4555-AV-AV	71-4531-48-48	X
	9m	81-4537-AV-AV	71-4540-48-48	71-4525-48-48	✓	71-4555-AV-AV	71-4531-48-48	X
	8m	81-4536-AV-AV	71-4540-48-48	71-4525-48-48	✓	71-4555-AV-AV	71-4531-48-48	X
	7m	81-3149-AV-AV	71-4540-48-48	71-4525-48-48	✓	71-4555-AV-AV	71-4531-48-48	X
CYLINDRICAL	7+4 m	81-3133-AU-AU	71-4522-48-48	71-4525-48-48	✓	X	71-3128-48-48	X
	7m	81-3132-AU-AU	71-4522-48-48	71-4525-48-48	✓	X	71-3128-48-48	X
SQUADRA	9m	81-4533-BP-AV	71-4540-48-48	71-4525-48-48	✓	X	71-4531-48-48	X
	7m	81-4532-BP-AV	71-4540-48-48	71-4525-48-48	✓	X	71-4531-48-48	X
ARC LATERAL	ARM	82-3030-BQ-BQ						
ELIPSE	ARM	82-3029-BQ-BQ						

ESENCIAL

CONICAL	6m	81-4535-AV-AV	71-4539-48-48	71-4524-48-48	71-4554-AV-AV	71-4555-AV-AV	71-4531-48-48	X
	5m	81-4534-AV-AV	71-4539-48-48	71-4524-48-48	71-4554-AV-AV	71-4555-AV-AV	71-4531-48-48	X
	4m	81-3151-AV-AV	71-4520-48-48	71-4524-48-48	71-4554-AV-AV	71-4555-AV-AV	71-4531-48-48	X
CYLINDRICAL	5m	81-3128-AU-AU	71-4539-48-48	71-4524-48-48	✓	X	71-3128-48-48	X
SQUADRA	6m	81-4531-BP-AV	71-4539-48-48	71-4524-48-48	✓	X	71-4531-48-48	X
SOLAR-ECO LATERAL	5m	81-3257-AV-AV	71-4539-48-48	71-4524-48-48	✓	X	71-4531-48-48	P. 798
SOLAR-TECH LATERAL	5m	81-4768-AV-AV	71-4521-48-48	71-4521-48-48	✓	X	71-4531-48-48	P. 799
ARC LATERAL	ARM	82-3030-BQ-BQ						
ELIPSE	ARM	82-3029-BQ-BQ						



OUTDOOR | URBAN



GAVINA LED



NEW

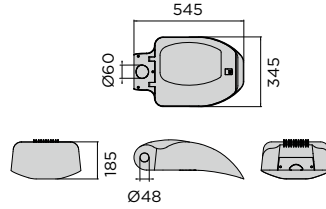

LED 65W
ULOR INST = 0,01%

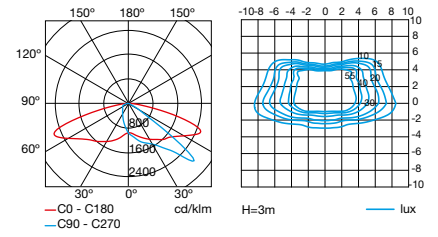

MEAN WELL



LED OSRAM Neutral white 4000K

65W 28 LED

6.117 lm^(N)

80-3238-BS-37

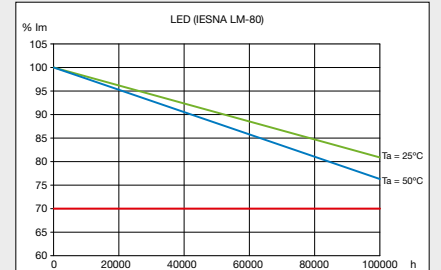
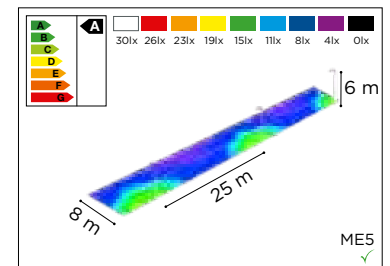
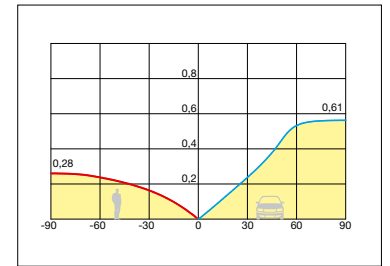

OUTDOOR | URBAN



GAVINA HID

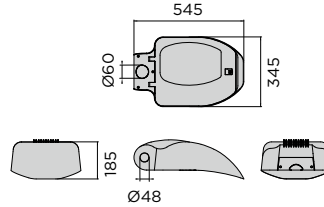

HPS 150W
ULOR INST = 0,01%

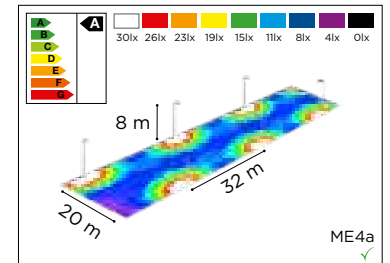
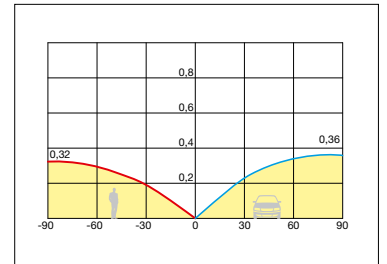
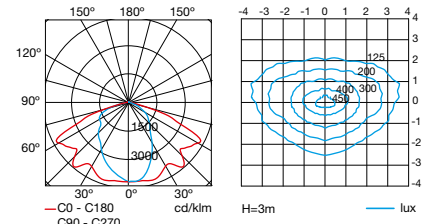

VOSSLOH
ELT

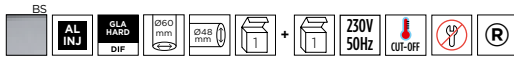

E-27

70W	HPS - MH		80-3044-BS-37
70W	HPS	2N	80-3047-BS-37
70W	HPS	2N TEMP	80-3054-BS-37
70W	HPS - MH		80-3057-BS-37

E-40

100W	HPS - MH		80-3045-BS-37
100W	HPS	2N	80-3048-BS-37
100W	HPS	2N TEMP	80-3055-BS-37
100W	HPS - MH		80-3058-BS-37
150W	HPS - MH		80-3046-BS-37
150W	HPS	2N	80-3049-BS-37
150W	HPS	2N TEMP	80-3056-BS-37
150W	HPS - MH		80-3059-BS-37

G-12

70W	MH		80-4829-BS-37
70W	MH		80-4830-BS-37
100W	MH		80-4831-BS-37
100W	MH		80-4832-BS-37
150W	MH		80-4833-BS-37
150W	MH		80-4834-BS-37

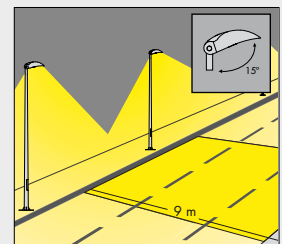
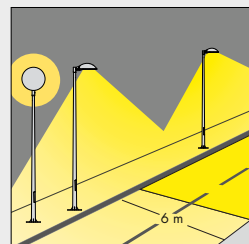

OUTDOOR | URBAN



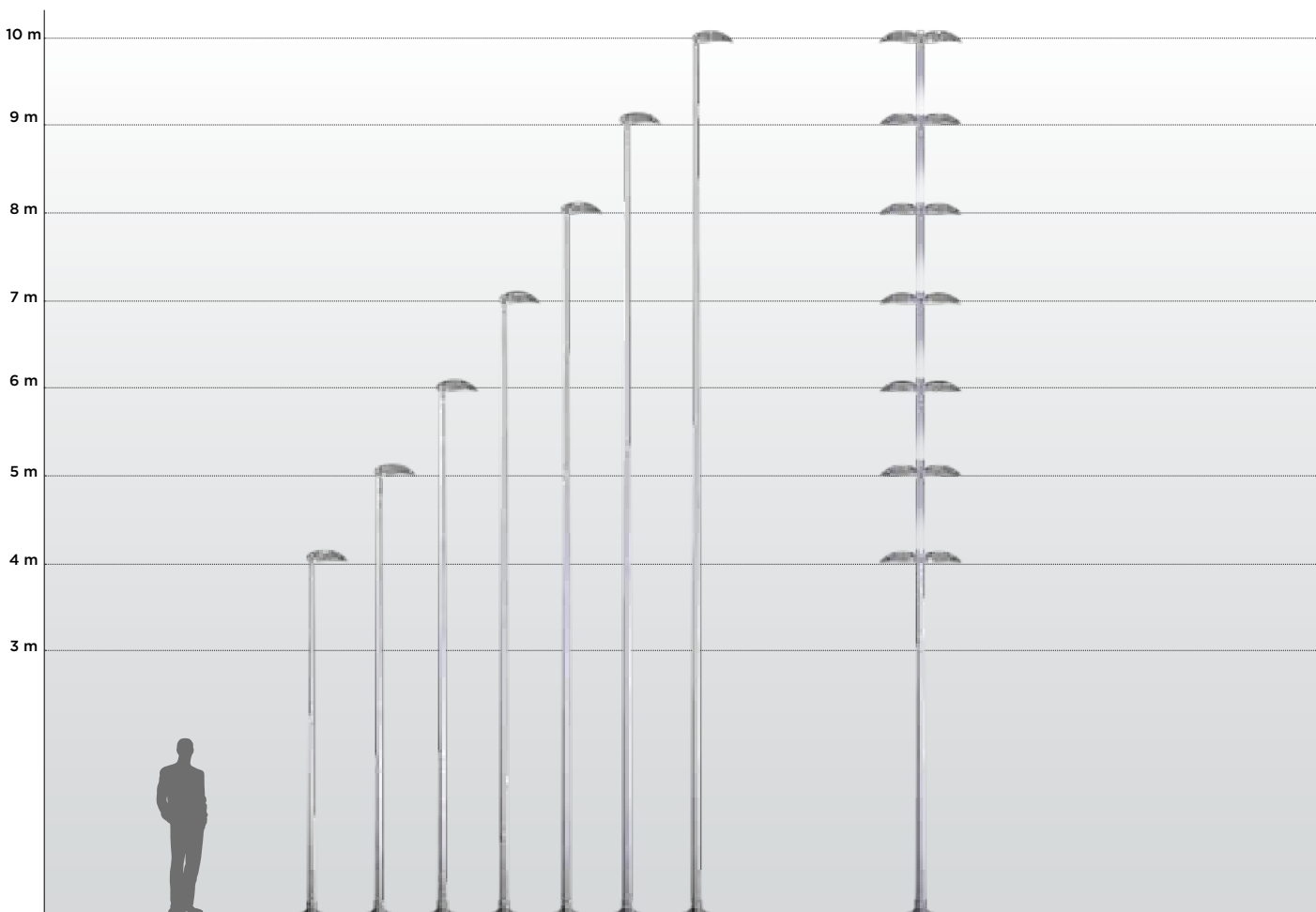

CONICAL
P. 801



CONICAL	10m	81-4538-AV-AV	71-4541-48-48	71-4525-48-48	✓	71-3044-AV-AV	71-4531-48-48
	9m	81-4537-AV-AV	71-4540-48-48	71-4525-48-48	✓	71-3044-AV-AV	71-4531-48-48
	8m	81-4536-AV-AV	71-4540-48-48	71-4525-48-48	✓	71-3044-AV-AV	71-4531-48-48
	7m	81-3149-AV-AV	71-4540-48-48	71-4525-48-48	✓	71-3044-AV-AV	71-4531-48-48
	6m	81-4535-AV-AV	71-4539-48-48	71-4524-48-48	✓	71-3044-AV-AV	71-4531-48-48
	5m	81-4534-AV-AV	71-4539-48-48	71-4524-48-48	✓	71-3044-AV-AV	71-4531-48-48
	4m	81-3151-AV-AV	71-4520-48-48	71-4524-48-48	✓	71-3044-AV-AV	71-4531-48-48



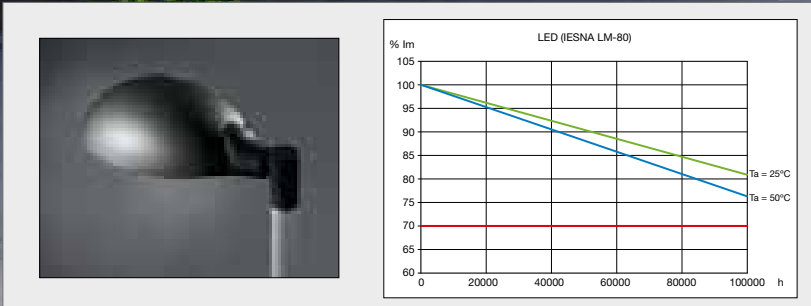

ELIPSE LED

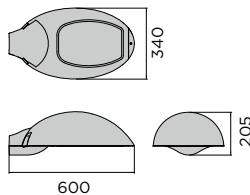

MEAN WELL



LED OSRAM Neutral white 4000K

30W	16 LED	2.896 lm ⁽ⁿ⁾		80-4610-BQ-37
45W	20 LED	4.345 lm ⁽ⁿ⁾		80-4614-BQ-37
45W	20 LED	4.345 lm ⁽ⁿ⁾	2N	80-4616-BQ-37
45W	20 LED	4.345 lm ⁽ⁿ⁾	2N TEMP	80-4615-BQ-37
65W	28 LED	6.117 lm ⁽ⁿ⁾		80-2696-BQ-37

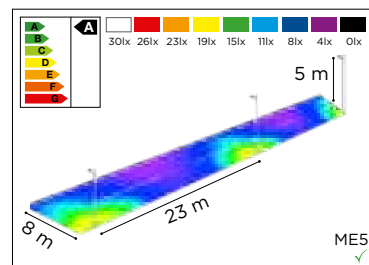
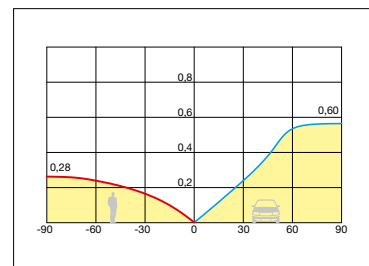
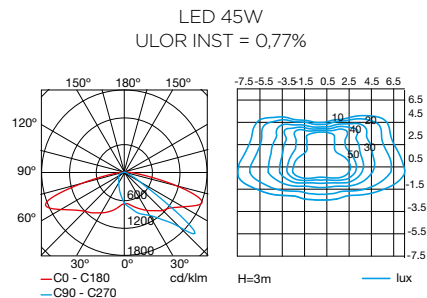

NEW

ELIPSE SOLAR

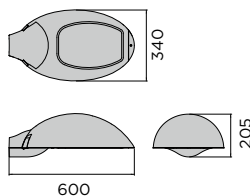

LED OSRAM Neutral white 4000K

30W	20 LED	2.896 lm ⁽ⁿ⁾		80-2467-BQ-37
45W	20 LED	4.345 lm ⁽ⁿ⁾		80-4768-BQ-37
65W	28 LED	6.117 lm ⁽ⁿ⁾		80-3274-BQ-37

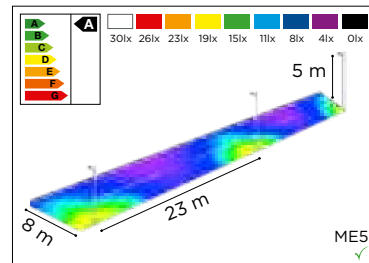
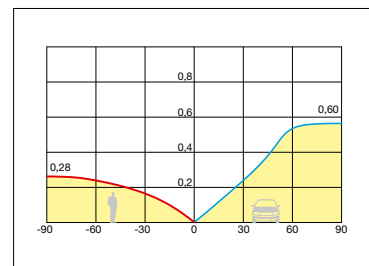
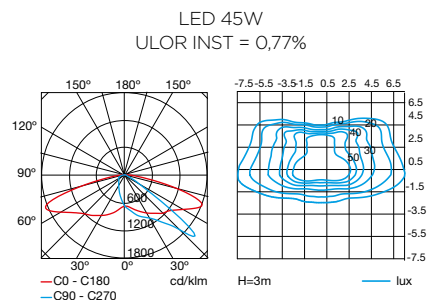

NEW



ELIPSE HID

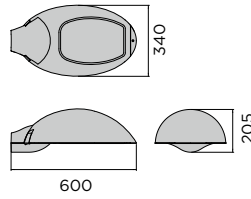

HPS 70W
ULOR INST = 0,15%

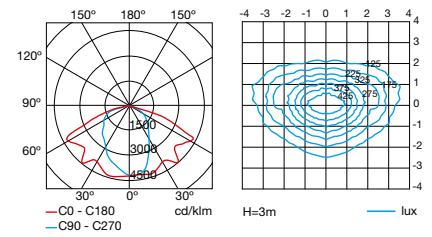

VOSSLOH
ELT

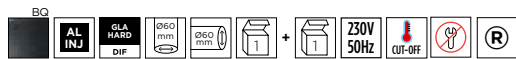

E-27

35W	MH		80-3065-BQ-37
35W	MH		80-3066-BQ-37
70W	HPS - MH		80-3029-BQ-37
70W	HPS	2N	80-3032-BQ-37
70W	HPS	2N TEMP	80-3039-BQ-37
70W	HPS - MH		80-3182-BQ-37
70W	HPS	2N	80-3067-BQ-37
70W	HPS	2N TEMP	80-3070-BQ-37

E-40

100W	HPS - MH		80-3030-BQ-37
100W	HPS	2N	80-3033-BQ-37
100W	HPS	2N TEMP	80-3040-BQ-37
100W	HPS - MH		80-3183-BQ-37
150W	HPS - MH		80-3031-BQ-37
150W	HPS	2N	80-3034-BQ-37
150W	HPS	2N TEMP	80-3041-BQ-37

G-12

70W	MH		80-4774-BQ-37
70W	MH		80-4775-BQ-37
100W	MH		80-4776-BQ-37
100W	MH		80-4777-BQ-37
150W	MH		80-4778-BQ-37

PGZ-12

45W	COSMOWHITE		PHILIPS	230V 50-60Hz		80-3062-BQ-37
60W	COSMOWHITE		PHILIPS	230V 50-60Hz		80-3063-BQ-37
90W	COSMOWHITE		PHILIPS	230V 50-60Hz		80-3064-BQ-37

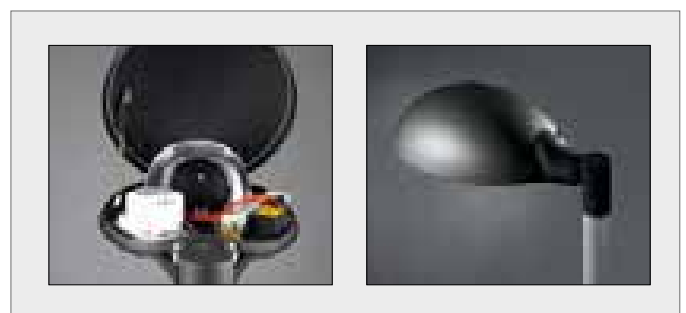
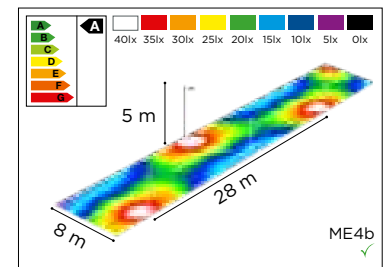
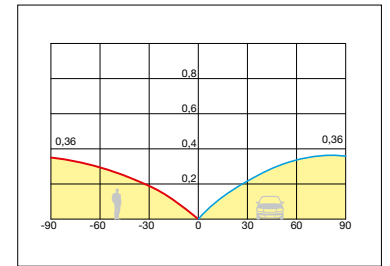

OUTDOOR | URBAN



L' ESTANY, BARCELONA, SPAIN

ELIPSE

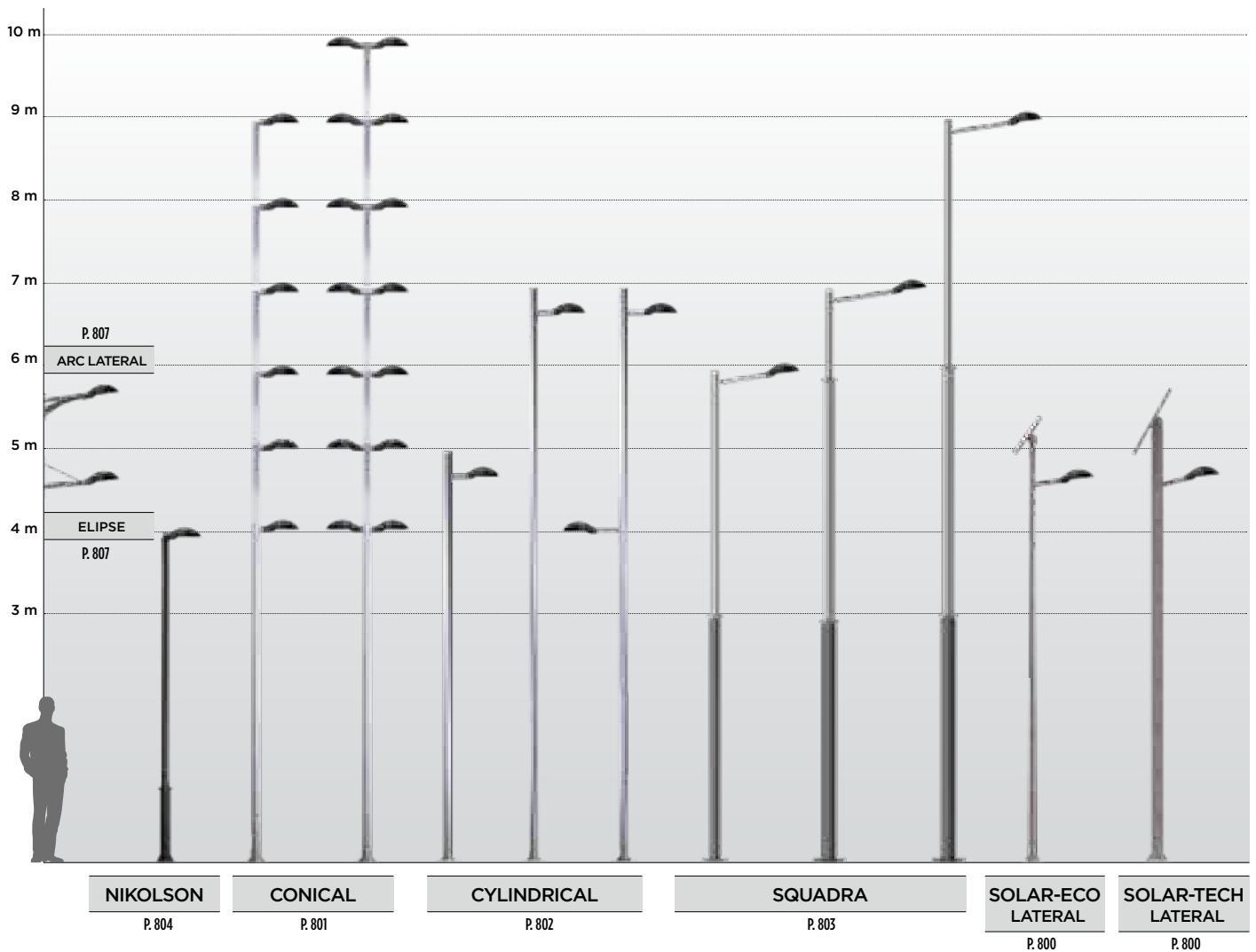

NIKOLSON	4m	81-3145-BP-BP ■	71-4520-48-48	71-4524-48-48	✓	71-4555-AV-AV ▨	71-3128-48-48	X
CONICAL	10m	81-4538-AV-AV ▨▨▨	71-4541-48-48	71-4525-48-48	✓	71-4555-AV-AV ▨▨▨	71-4531-48-48	X
	9m	81-4537-AV-AV ▨▨▨	71-4540-48-48	71-4525-48-48	✓	71-4555-AV-AV ▨▨▨	71-4531-48-48	X
	8m	81-4536-AV-AV ▨▨▨	71-4540-48-48	71-4525-48-48	✓	71-4555-AV-AV ▨▨▨	71-4531-48-48	X
	7m	81-3149-AV-AV ▨▨▨	71-4540-48-48	71-4525-48-48	✓	71-4555-AV-AV ▨▨▨	71-4531-48-48	X
	6m	81-4535-AV-AV ▨▨▨	71-4539-48-48	71-4524-48-48	✓	71-4555-AV-AV ▨▨▨	71-4531-48-48	X
	5m	81-4534-AV-AV ▨▨▨	71-4539-48-48	71-4524-48-48	✓	71-4555-AV-AV ▨▨▨	71-4531-48-48	X
	4m	81-3151-AV-AV ▨▨▨	71-4520-48-48	71-4524-48-48	✓	71-4555-AV-AV ▨▨▨	71-4531-48-48	X
CYLINDRICAL	7+ 4m	81-3133-AU-AU ■	71-4522-48-48	71-4525-48-48	✓	X	71-3128-48-48	X
	7m	81-3132-AU-AU ■	71-4522-48-48	71-4525-48-48	✓	X	71-3128-48-48	X
	5m	81-3128-AU-AU ■	71-4539-48-48	71-4524-48-48	✓	X	71-3128-48-48	X
SQUADRA	9m	81-4533-BP-AV ■▨▨▨	71-4540-48-48	71-4525-48-48	✓	X	71-4531-48-48	X
	7m	81-4532-BP-AV ■▨▨▨	71-4540-48-48	71-4525-48-48	✓	X	71-4531-48-48	X
	6m	81-4531-BP-AV ■▨▨▨	71-4539-48-48	71-4524-48-48	✓	X	71-4531-48-48	X
SOLAR-ECO LATERAL	5m	81-3257-AV-AV ■	71-4539-48-48	71-4524-48-48	✓	X	71-4531-48-48	P. 798
SOLAR-TECH LATERAL	5m	81-4768-AV-AV ■	71-4521-48-48	71-4525-48-48	✓	X	71-4531-48-48	P. 799
ARC LATERAL	ARM	82-3030-BQ-BQ ■						
ELIPSE	ARM	82-3029-BQ-BQ ■						



OUTDOOR | URBAN



MINI ROADWAY HID

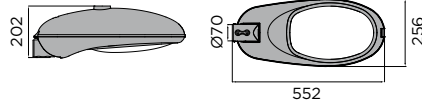

HPS 150W
ULOR INST = 0,00%

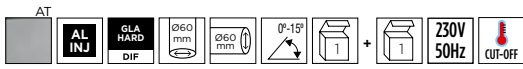
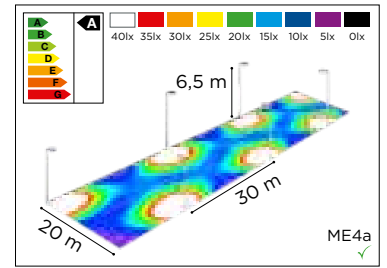
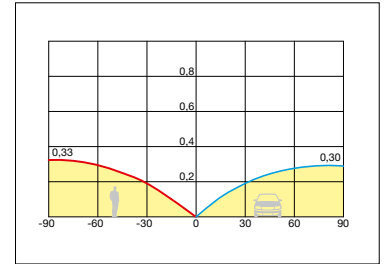
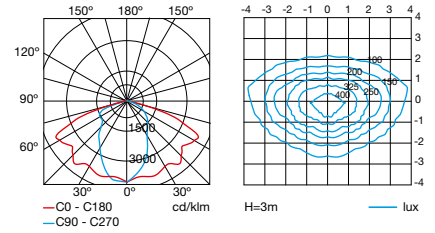

E-27

50W	HPS		80-2438-AT-37
50W	HPS	2N	80-2442-AT-37
50W	HPS	2N TEMP	80-2446-AT-37
70W	HPS - MH		80-2439-AT-37
70W	HPS	2N	80-2443-AT-37
70W	HPS	2N TEMP	80-2447-AT-37

E-40

100W	HPS - MH		80-2440-AT-37
100W	HPS	2N	80-2444-AT-37
100W	HPS	2N TEMP	80-2448-AT-37
150W	HPS - MH		80-2441-AT-37
150W	HPS	2N	80-2445-AT-37
150W	HPS	2N TEMP	80-2449-AT-37



OUTDOOR | URBAN



ROADWAY HID

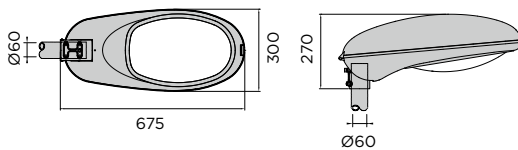

HPS 150W
ULOR INST = 0,00%

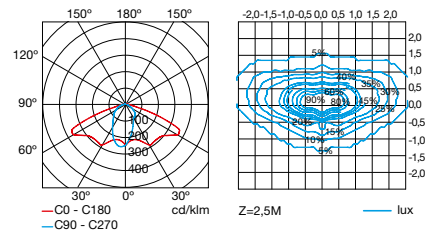

IP 64 IP 66 IK 08 3 YEAR WARRANTY VOSSLOH ELT

AT AL INJ GLA HARD DIP Ø60 mm Ø60 mm 0°-15° 1 + 1 230V 50Hz CUT-OFF

E-27

70W	HPS - MH	⊕	80-3071-AT-37
70W	HPS	⊕ 2N	80-3074-AT-37
70W	HPS	⊕ 2N TEMP	80-3083-AT-37
70W	HPS - MH	□	80-3087-AT-37
70W	HPS	□ 2N	80-3091-AT-37
70W	HPS	□ 2N TEMP	80-3095-AT-37

E-40

WITHOUT GEAR

100W	HPS - MH	⊕	80-4771-AT-37
100W	HPS	⊕ 2N	80-3072-AT-37
100W	HPS	⊕ 2N TEMP	80-3075-AT-37
100W	HPS - MH	□	80-3084-AT-37
100W	HPS	□ 2N	80-3088-AT-37
100W	HPS	□ 2N TEMP	80-3092-AT-37
100W	HPS	□ 2N TEMP	80-3096-AT-37
150W	HPS - MH	⊕	80-3073-AT-37
150W	HPS	⊕ 2N	80-3076-AT-37
150W	HPS	⊕ 2N TEMP	80-3085-AT-37
150W	HPS - MH	□	80-3089-AT-37
150W	HPS	□ 2N	80-3093-AT-37
150W	HPS	□ 2N TEMP	80-3097-AT-37
250W	HPS - MH	⊕	80-3081-AT-37
250W	HPS	⊕ 2N	80-3082-AT-37
250W	HPS	⊕ 2N TEMP	80-3086-AT-37
250W	HPS - MH	□	80-3090-AT-37
250W	HPS	□ 2N	80-3094-AT-37
250W	HPS	□ 2N TEMP	80-3098-AT-37
400W	HPS - MH	⊕	80-2674-AT-37
400W	HPS	⊕ 2N	80-3252-AT-37
400W	HPS	⊕ 2N TEMP	80-3253-AT-37

G-12

70W	MH	⊕	80-4838-AT-37
70W	MH	□	80-4839-AT-37
100W	MH	⊕	80-4840-AT-37
100W	MH	□	80-4841-AT-37
150W	MH	⊕	80-4842-AT-37
150W	MH	□	80-4843-AT-37

PGZ-12

45W	COSMOWHITE	⊕ PHILIPS 230V 50-60Hz	80-4598-AT-37
60W	COSMOWHITE	⊕ PHILIPS 230V 50-60Hz	80-4599-AT-37
90W	COSMOWHITE	⊕ PHILIPS 230V 50-60Hz	80-4600-AT-37
140W	COSMOWHITE	⊕ PHILIPS 230V 50-60Hz	80-4601-AT-37

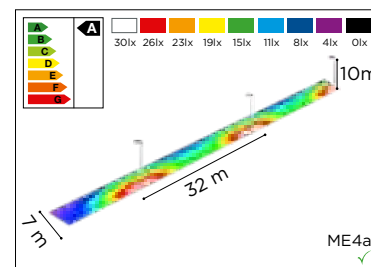
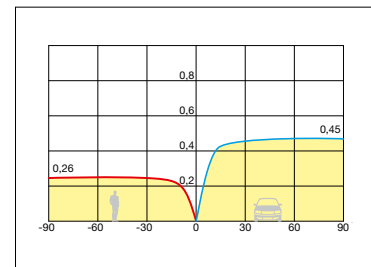

NEW
NEW
NEW



OUTDOOR | URBAN



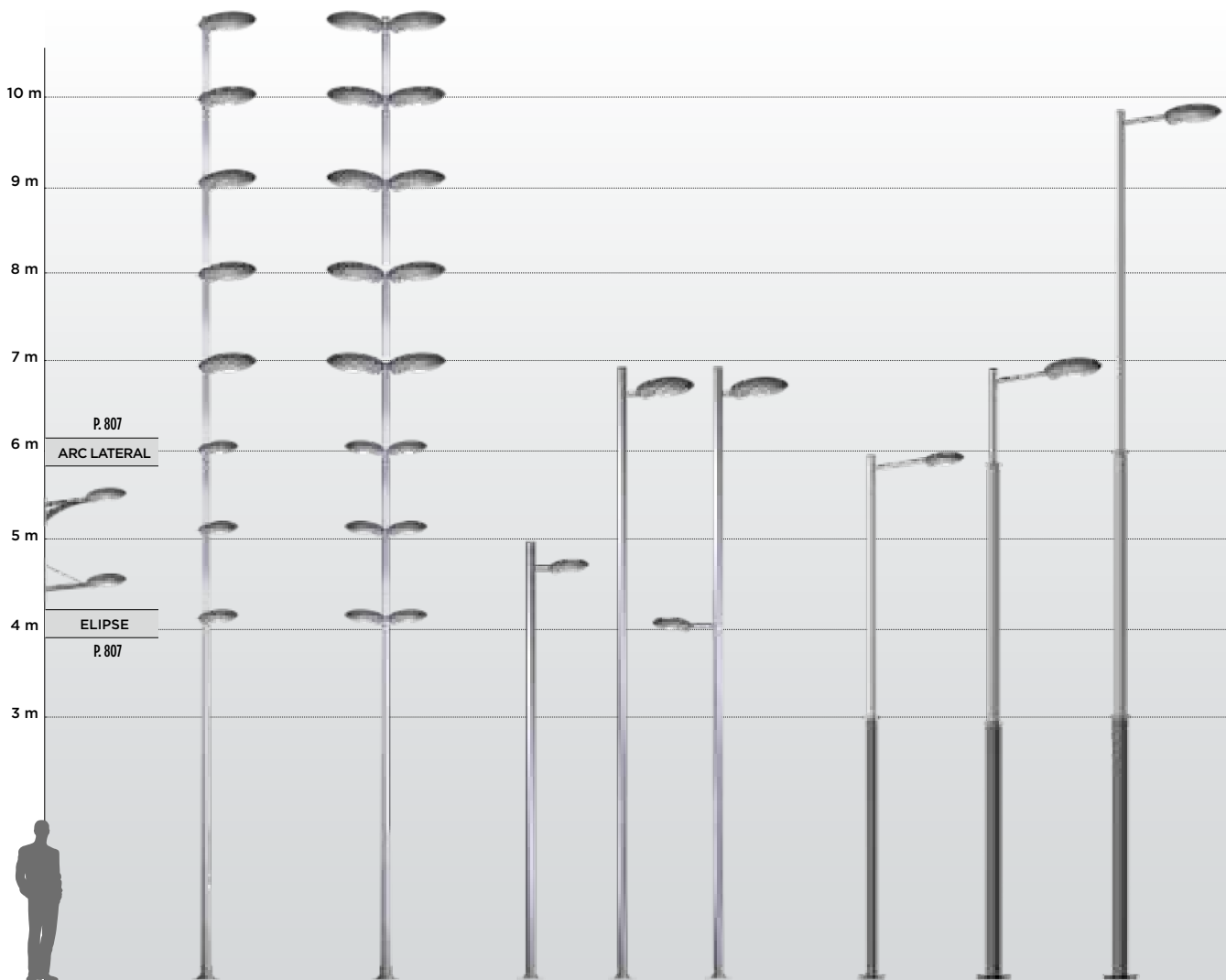

CONICAL P. 801 **CYLINDRICAL** P. 802 **SQUADRA** P. 803



CONICAL	10m	81-4538-AV-AV	71-4541-48-48	71-4525-48-48	✓	71-4555-AV-AV	71-4531-48-48
	9m	81-4537-AV-AV	71-4540-48-48	71-4525-48-48	✓	71-4555-AV-AV	71-4531-48-48
	8m	81-4536-AV-AV	71-4540-48-48	71-4525-48-48	✓	71-4555-AV-AV	71-4531-48-48
	7m	81-3149-AV-AV	71-4540-48-48	71-4525-48-48	✓	71-4555-AV-AV	71-4531-48-48
CYLINDRICAL	7+4 m	81-3133-AU-AU	71-4522-48-48	71-4525-48-48	✓	X	71-3128-48-48
	7m	81-3132-AU-AU	71-4522-48-48	71-4525-48-48	✓	X	71-3128-48-48
SQUADRA	9m	81-4533-BP-AV	71-4540-48-48	71-4525-48-48	✓	X	71-4531-48-48
	7m	81-4532-BP-AV	71-4540-48-48	71-4525-48-48	✓	X	71-4531-48-48

ARC LATERAL	ARM	82-3030-BQ-BQ
ELIPSE	ARM	82-3029-BQ-BQ

CONICAL	6m	81-4535-AV-AV	71-4539-48-48	71-4524-48-48	71-4554-AV-AV	71-4555-AV-AV	71-4531-48-48
	5m	81-4534-AV-AV	71-4539-48-48	71-4524-48-48	71-4554-AV-AV	71-4555-AV-AV	71-4531-48-48
	4m	81-3151-AV-AV	71-4520-48-48	71-4524-48-48	71-4554-AV-AV	71-4555-AV-AV	71-4531-48-48
CYLINDRICAL	5m	81-3128-AU-AU	71-4539-48-48	71-4524-48-48	✓	X	71-3128-48-48
SQUADRA	6m	81-4531-BP-AV	71-4539-48-48	71-4524-48-48	✓	X	71-4531-48-48
ARC LATERAL	ARM	82-3030-BQ-BQ					
ELIPSE	ARM	82-3029-BQ-BQ					





ECOVIAL HID

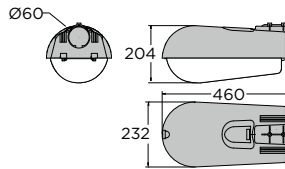

HPS 70W
ULOR INST = 1,64%

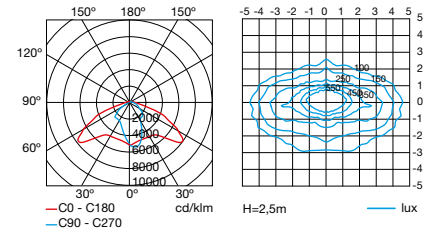

VOSSLOH

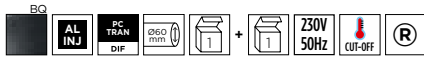

E-27

35W MH	80-4573-BQ-M2
70W HPS - MH	80-4574-BQ-M2

E-40

100W HPS - MH	80-4575-BQ-M2
150W HPS - MH	80-4576-BQ-M2

G-12

70W MH	80-4835-BQ-M2
100W MH	80-4836-BQ-M2
150W MH	80-4837-BQ-M2

PGZ-12



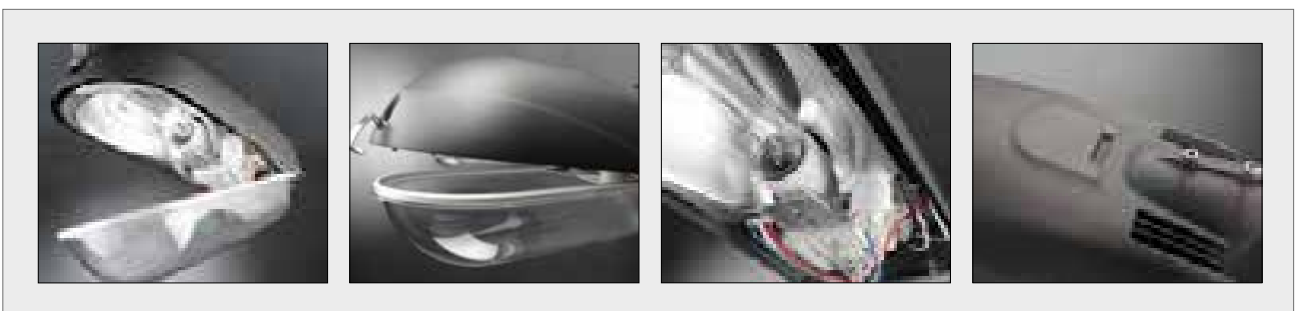
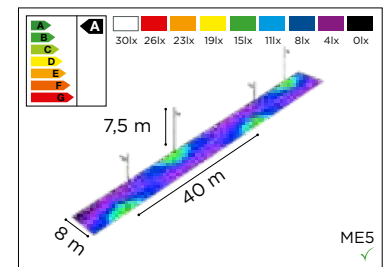
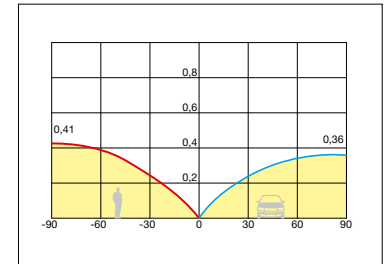



45W COSMOWHITE	PHILIPS	230V 50-60Hz	80-4577-BQ-M2
60W COSMOWHITE	PHILIPS	230V 50-60Hz	80-4578-BQ-M2
90W COSMOWHITE	PHILIPS	230V 50-60Hz	80-4579-BQ-M2

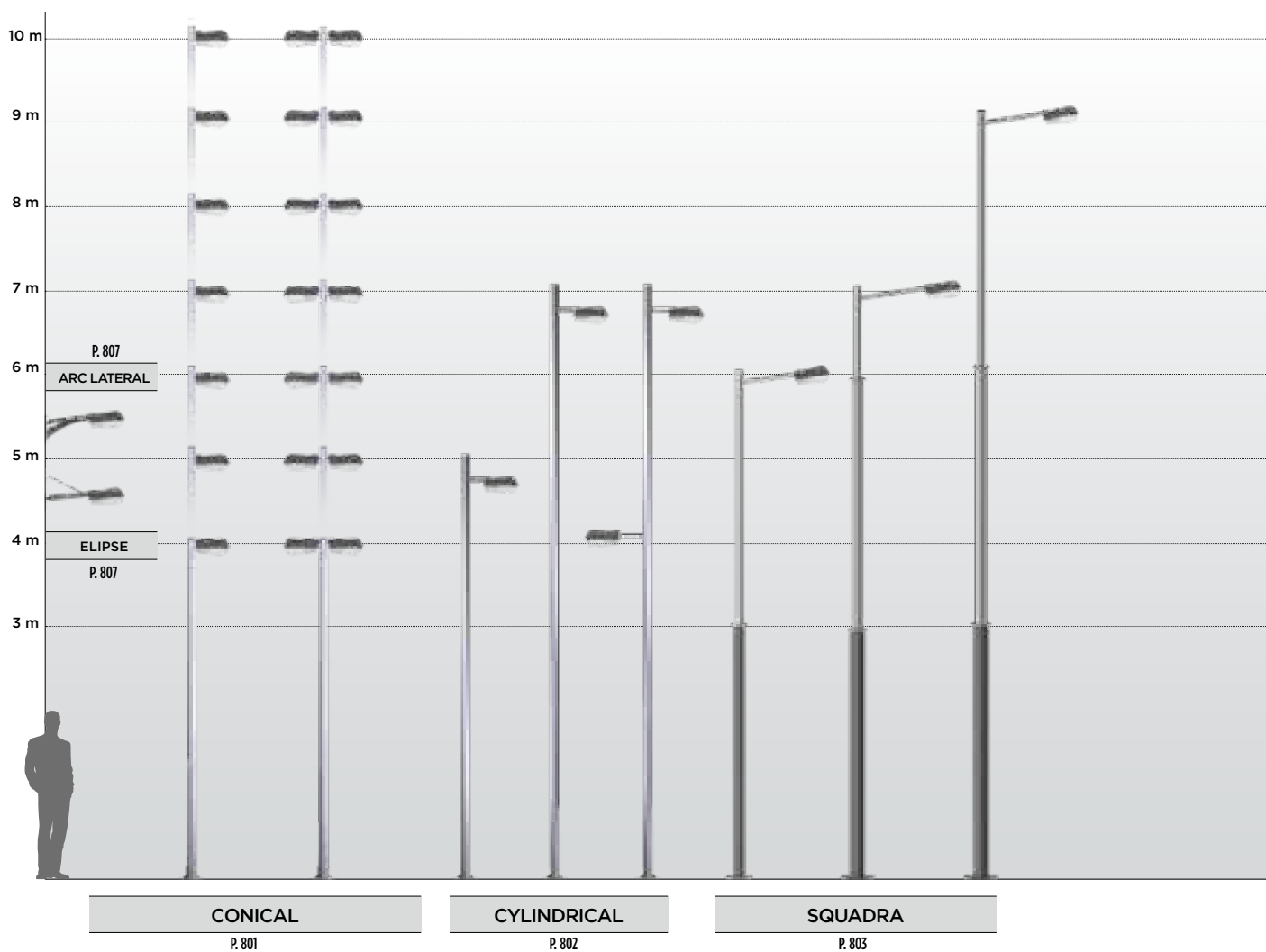

OUTDOOR | URBAN





							
CONICAL	10m	81-4538-AV-AV ■■■	71-4541-48-48	71-4525-48-48	71-4554-AV-AV ■■■	71-4555-AV-AV ■■■	71-4531-48-48
	9m	81-4537-AV-AV ■■■	71-4540-48-48	71-4525-48-48	71-4554-AV-AV ■■■	71-4555-AV-AV ■■■	71-4531-48-48
	8m	81-4536-AV-AV ■■■	71-4540-48-48	71-4525-48-48	71-4554-AV-AV ■■■	71-4555-AV-AV ■■■	71-4531-48-48
	7m	81-3149-AV-AV ■■■	71-4540-48-48	71-4525-48-48	71-4554-AV-AV ■■■	71-4555-AV-AV ■■■	71-4531-48-48
	6m	81-4535-AV-AV ■■■	71-4539-48-48	71-4524-48-48	71-4554-AV-AV ■■■	71-4555-AV-AV ■■■	71-4531-48-48
	5m	81-4534-AV-AV ■■■	71-4539-48-48	71-4524-48-48	71-4554-AV-AV ■■■	71-4555-AV-AV ■■■	71-4531-48-48
	4m	81-3151-AV-AV ■■■	71-4520-48-48	71-4524-48-48	71-4554-AV-AV ■■■	71-4555-AV-AV ■■■	71-4531-48-48
CYLINDRICAL	7+ 4 m	81-3133-AU-AU ■	71-4522-48-48	71-4525-48-48	✓	X	71-3128-48-48
	7m	81-3132-AU-AU ■	71-4522-48-48	71-4525-48-48	✓	X	71-3128-48-48
	5m	81-3128-AU-AU ■	71-4539-48-48	71-4524-48-48	✓	X	71-3128-48-48
SQUADRA	9m	81-4533-BP-AV ■■■	71-4540-48-48	71-4525-48-48	✓	X	71-4531-48-48
	7m	81-4532-BP-AV ■■■	71-4540-48-48	71-4525-48-48	✓	X	71-4531-48-48
	6m	81-4531-BP-AV ■■■	71-4539-48-48	71-4524-48-48	✓	X	71-4531-48-48
ARC LATERAL	ARM	82-3030-BQ-BQ ■					
ELIPSE	ARM	82-3029-BQ-BQ ■					



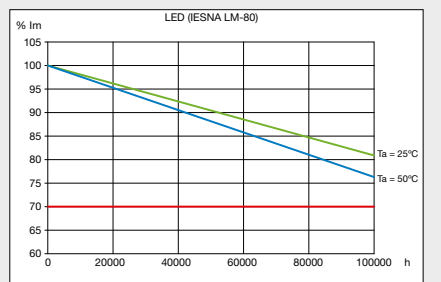
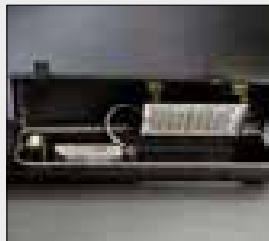

PROMENADE FLUO

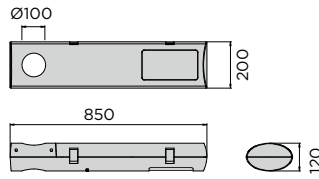

VOSSLOH

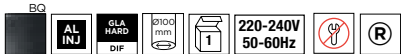

Gx24 q-5

57W FLUORESCENT

80-3023-BQ-37

FLUO 57W
ULOR INST = 0,00%

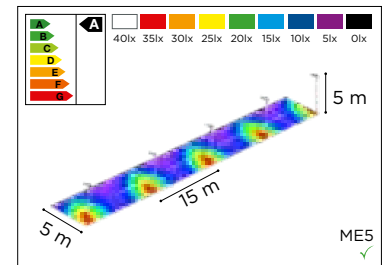
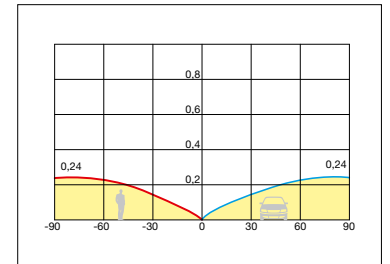
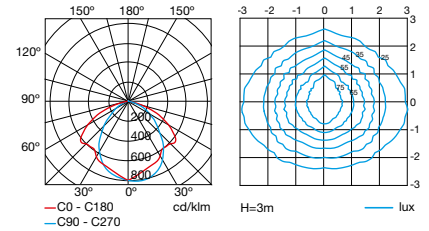

PROMENADE LED

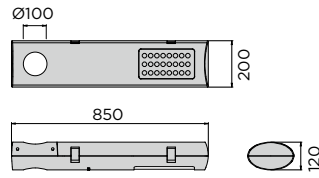

MEAN WELL



LED OSRAM Neutral white 4000K

30W	16 LED	3.041 lm ^(N)		80-4618-BQ-37
45W	20 LED	4.561 lm ^(N)		80-4622-BQ-37
45W	20 LED	4.561 lm ^(N)	ZN	80-4624-BQ-37
45W	20 LED	4.561 lm ^(N)	ZN TEMP	80-4623-BQ-37
56W	24 LED	5.676 lm ^(N)		80-2693-BQ-37
56W	24 LED	5.676 lm ^(N)	ZN	80-2695-BQ-37
56W	24 LED	5.676 lm ^(N)	ZN TEMP	80-2694-BQ-37

LED 45W
ULOR INST = 0,00%

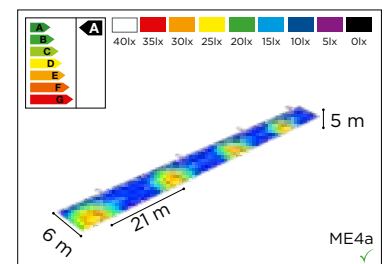
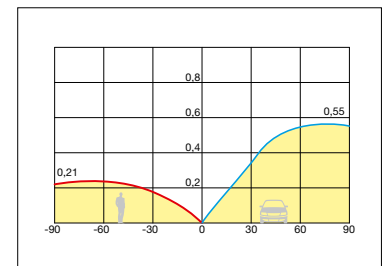
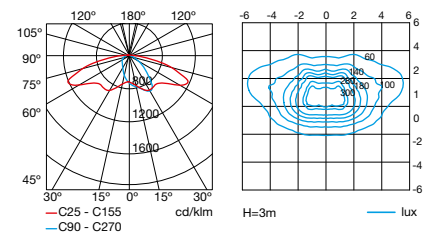

NEW
NEW
NEW



OUTDOOR | URBAN

PROMENADE HID

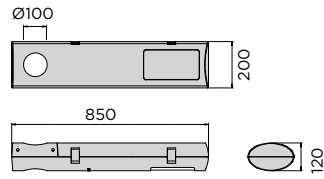

VOSSLOH



E-27

35W	MH		80-4521-BQ-37
35W	MH		80-4522-BQ-37
70W	HPS - MH		80-4502-BQ-37
70W	HPS	2N	80-4505-BQ-37
70W	HPS	2N TEMP	80-4508-BQ-37
70W	HPS	2N	80-4514-BQ-37
70W	HPS	2N TEMP	80-4517-BQ-37
70W	HPS - MH		80-4511-BQ-37

E-40

100W	HPS - MH		80-4503-BQ-37
100W	HPS	2N	80-4506-BQ-37
100W	HPS	2N TEMP	80-4509-BQ-37
100W	HPS - MH		80-4518-BQ-37
100W	HPS	2N	80-4512-BQ-37
100W	HPS	2N TEMP	80-4515-BQ-37
150W	HPS - MH		80-4504-BQ-37
150W	HPS	2N	80-4507-BQ-37
150W	HPS	2N TEMP	80-4510-BQ-37
150W	HPS - MH		80-4513-BQ-37
150W	HPS	2N	80-4516-BQ-37
150W	HPS	2N TEMP	80-4519-BQ-37

G-12

35W	MH		80-4494-BQ-37
35W	MH		80-4498-BQ-37
70W	MH		80-4495-BQ-37
70W	MH		80-4499-BQ-37
100W	MH		80-4496-BQ-37
100W	MH		80-4500-BQ-37
150W	MH		80-4497-BQ-37
150W	MH		80-4501-BQ-37

PGZ-12

45W	COSMOWHITE	PHILIPS	230V 50-60Hz		80-4602-BQ-37
60W	COSMOWHITE	PHILIPS	230V 50-60Hz		80-4603-BQ-37
90W	COSMOWHITE	PHILIPS	230V 50-60Hz		80-4604-BQ-37

HPS 70W
ULOR INST = 0,58%

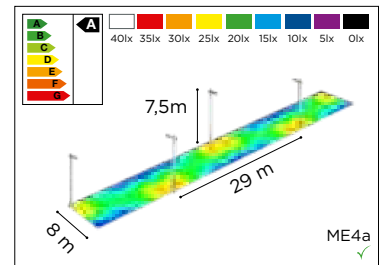
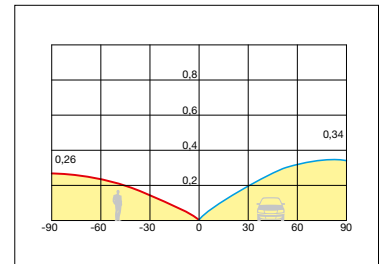
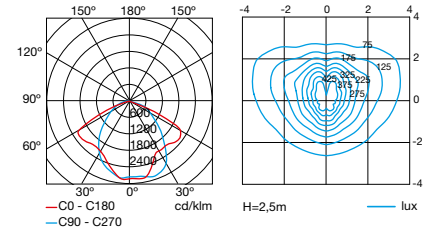

PROMENADE

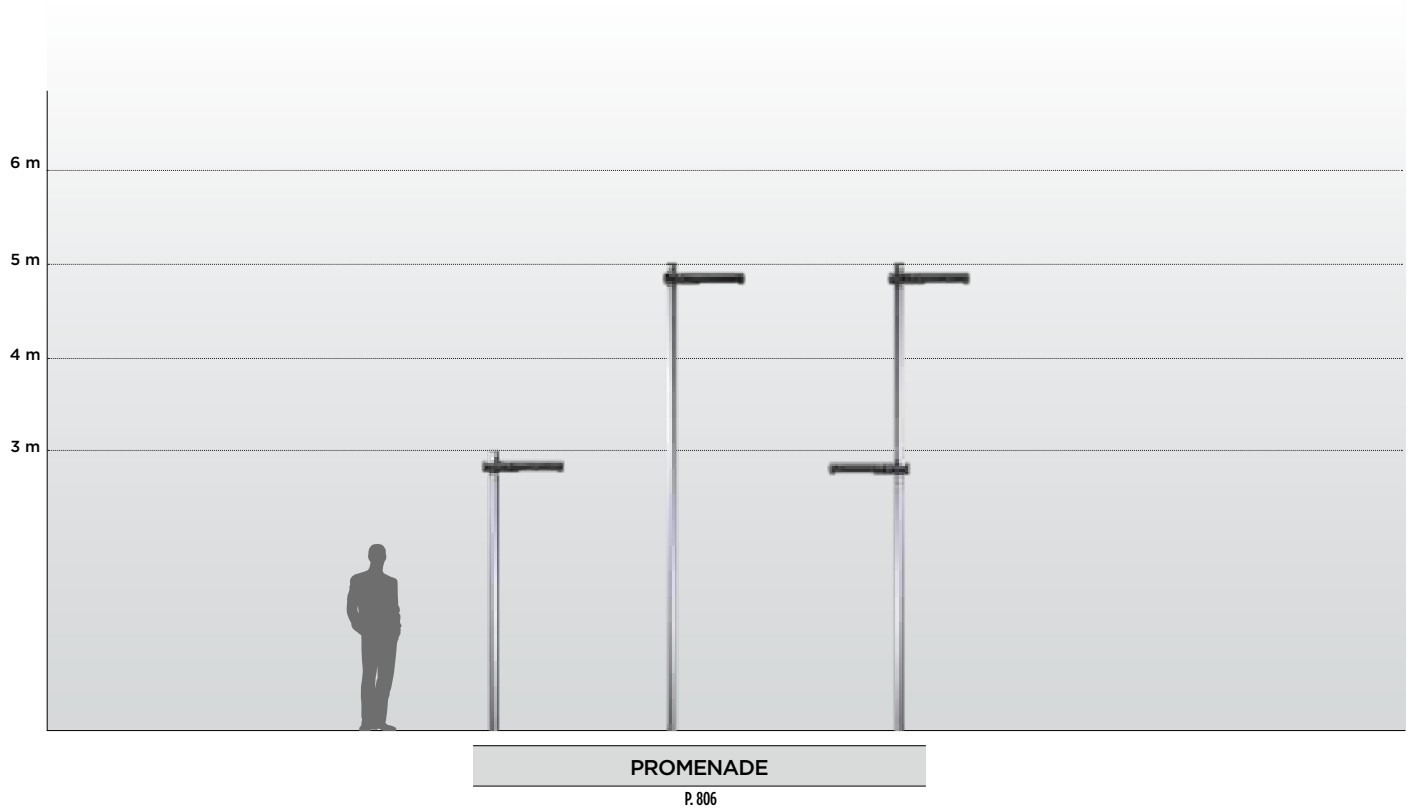

3m	81-3137-AU-AU	71-4520-48-48	71-4524-48-48	✓	X	71-4531-48-48
5m	81-3140-AU-AU	71-4539-48-48	71-4524-48-48	✓	X	71-4531-48-48
5+3m	81-3140-AU-AU	71-4539-48-48	71-4524-48-48	✓	X	71-4531-48-48



PLAÇA VALL, TORÀ, SPAIN







45 W 80-4553-AU-M2

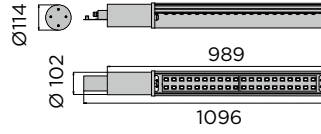

80 W 80-4552-AU-M2

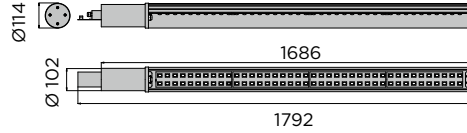

LED 80W
ULOR INST = 1,58%

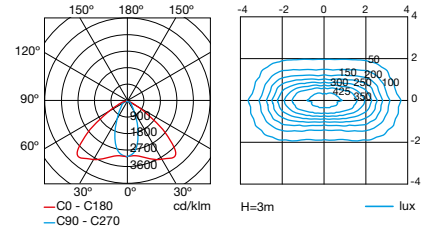

MEAN WELL



LED LUMILED Neutral white 4000K

45W	40 LED	3.839 lm ^(N)	80-4553-AU-M2
80W	80 LED	6.824 lm ^(N)	80-4552-AU-M2

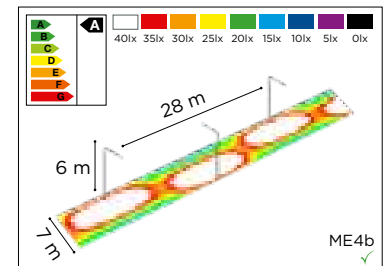
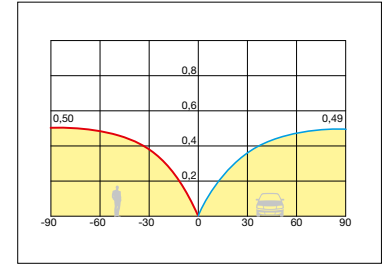

OUTDOOR | URBAN

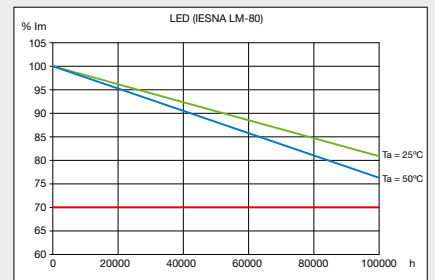
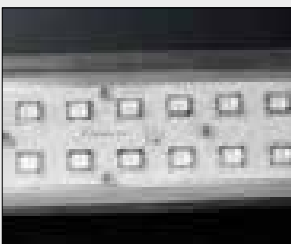



RUBÍ, BARCELONA, SPAIN

PILED

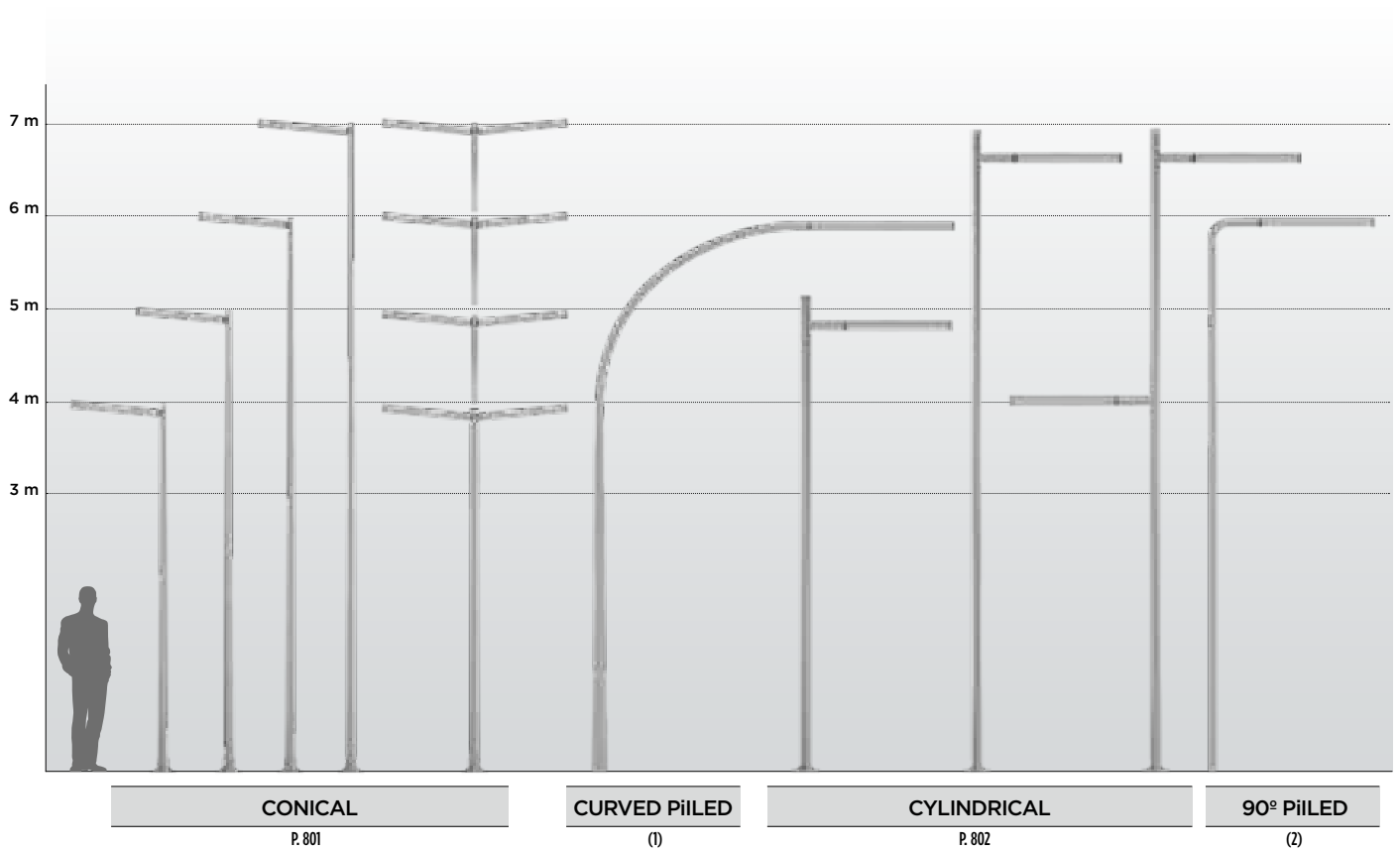

CONICAL

P. 801

CURVED PILED

(1)

CYLINDRICAL

P. 802

90° PILED

(2)



CONICAL	7m	81-3149-AV-AV		71-4540-48-48	71-4525-48-48	71-4553-AV-AV		71-4554-AV-AV		71-4555-AV-AV		71-4531-48-48
	6m	81-4535-AV-AV		71-4539-48-48	71-4524-48-48	71-4553-AV-AV		71-4554-AV-AV		71-4555-AV-AV		71-4531-48-48
	5m	81-4534-AV-AV		71-4539-48-48	71-4524-48-48	71-4553-AV-AV		71-4554-AV-AV		71-4555-AV-AV		71-4531-48-48
	4m	81-3151-AV-AV		71-4520-48-48	71-4524-48-48	71-4553-AV-AV		71-4554-AV-AV		71-4555-AV-AV		71-4531-48-48
CYLINDRICAL	7+4 m	81-3133-AU-AU	■	71-4522-48-48	71-4525-48-48	71-4553-AV-AV		✓		X		71-3128-48-48
	7m	81-3132-AU-AU	■	71-4522-48-48	71-4525-48-48	71-4553-AV-AV		✓		X		71-3128-48-48
	5m	81-3128-AU-AU	■	71-4539-48-48	71-4524-48-48	71-4553-AV-AV		✓		X		71-3128-48-48
90° PILED	6m	81-4558-AV-AV		71-4539-48-48	71-4524-48-48			✓		✓	X	71-4531-48-48
	5m	81-4557-AV-AV		71-4539-48-48	71-4524-48-48			✓		✓	X	71-4531-48-48
	4m	81-4556-AV-AV		71-4539-48-48	71-4524-48-48			✓		✓	X	71-4531-48-48
CURVED PILED	6m	81-4552-AV-AV		71-4556-48-48	71-4525-48-48			✓		✓	X	71-4531-48-48

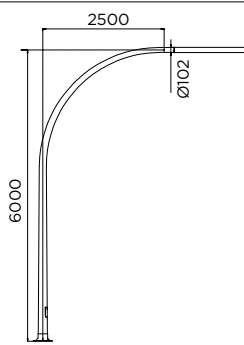

(1)

CURVED PILED

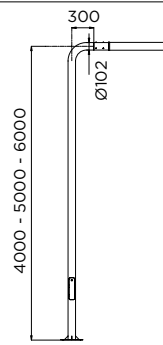

(2)

90° PILED





CITIZEN LED



NEW

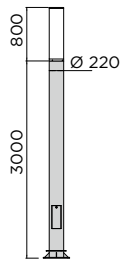

LED 56W
ULOR INST = 2,08%

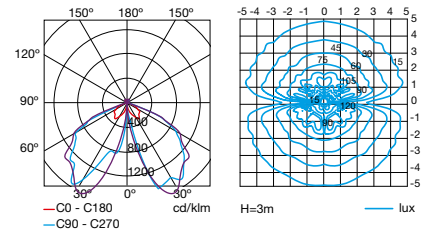

MEAN WELL

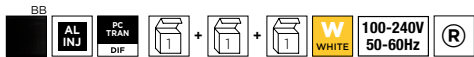

CITIZEN COB LED Neutral white 3000K

60W LED

6082 lm^(N)

83-3239-BB-M2 ⁽¹⁾

- ⁽¹⁾ EL CÓDIGO INCLUYE CABEZAL Y COLUMNA.
- ⁽²⁾ THE CODE INCLUDES HEAD AND POLE.
- ⁽³⁾ LE CODE COMPREND LA TÊTE ET LE MÂT.
- ⁽⁴⁾ DIESE ARTIKEL-NR. ENTHÄLT DEN MAST UND DEN LEUCHTENKOPF.
- ⁽⁵⁾ IL CODICE INCLUDE TESTA E COLONNA.
- ⁽⁶⁾ O CÓDIGO INCLUI A CABEÇA E A COLUNA.
- ⁽⁷⁾ АРТИКУЛ ВКЛЮЧАЕТ СВЕТИЛЬНИК И ОПОРУ.
- ⁽⁸⁾ TEN KOD OBEJMUJE GŁÓWICĘ I SŁUP.



71-4521-48-48

71-4526-48-48

71-3148-48-48

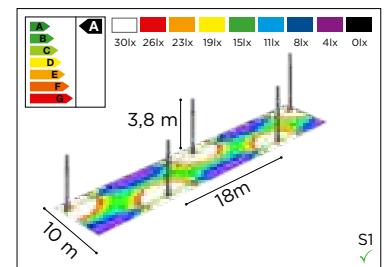
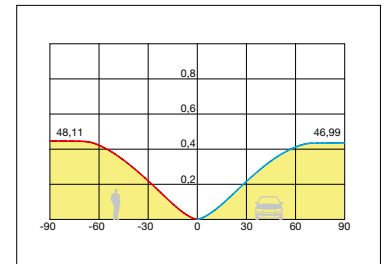

OUTDOOR | URBAN

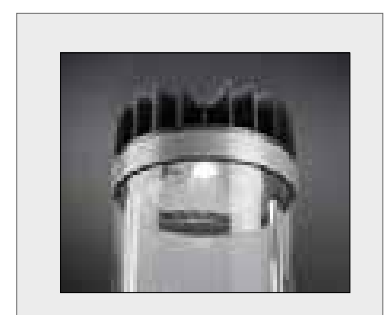



CITIZEN HID

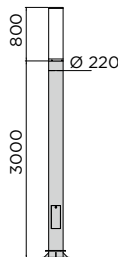

MH 70W
ULOR INST = 2,08%

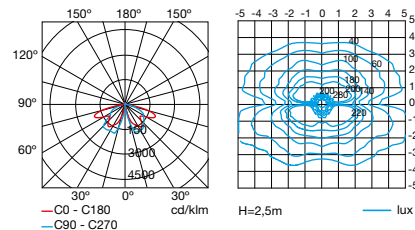

VOSSLOH

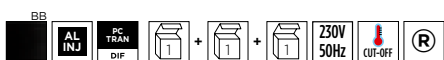

G-12

35W	MH		83-4580-BB-M2 ⁽¹⁾
35W	MH		83-4584-BB-M2 ⁽¹⁾
70W	MH		83-4581-BB-M2 ⁽¹⁾
70W	MH		83-4585-BB-M2 ⁽¹⁾
100W	MH		83-4582-BB-M2 ⁽¹⁾
100W	MH		83-4586-BB-M2 ⁽¹⁾
150W	MH		83-4583-BB-M2 ⁽¹⁾
150W	MH	2N	83-4588-BB-M2 ⁽¹⁾
150W	MH	2N	83-4590-BB-M2 ⁽¹⁾
150W	MH		83-4587-BB-M2 ⁽¹⁾
150W	MH	2N	83-4589-BB-M2 ⁽¹⁾
150W	MH	2N	83-4591-BB-M2 ⁽¹⁾

PGZ-12

45W	COSMOWHITE	PHILIPS		83-4608-BB-M2 ⁽¹⁾
60W	COSMOWHITE	PHILIPS		83-4609-BB-M2 ⁽¹⁾

- ⁽¹⁾ EL CÓDIGO INCLUYE CABEZAL Y COLUMNA.
- ⁽¹⁾ THE CODE INCLUDES HEAD AND POLE.
- ⁽¹⁾ LE CODE COMPREND LA TÊTE ET LE MÂT.
- ⁽¹⁾ DIESE ARTIKEL-NR. ENTHÄLT DEN MAST UND DEN LEUCHTENKOPF.
- ⁽¹⁾ IL CODICE INCLUDE TESTA E COLONNA.
- ⁽¹⁾ O CÓDIGO INCLUI A CABEÇA E A COLUNA.
- ⁽¹⁾ АРТИКУЛ ВКЛЮЧАЕТ СВЕТИЛЬНИК И ОПОРУ.
- ⁽¹⁾ TEN KOD OBEJMUJE GŁOWICĘ I SŁUP.



71-4521-48-48 71-4526-48-48 71-3148-48-48

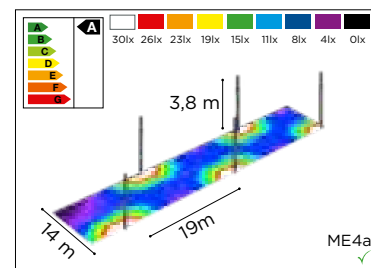
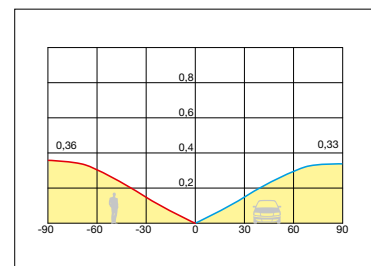

OUTDOOR | URBAN





SANT VICENÇ DELS HORTS, BARCELONA, SPAIN

CITIZEN HID

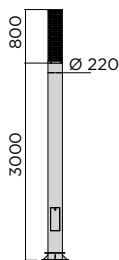

HPS 2X70W
ULOR INST = 10,3%

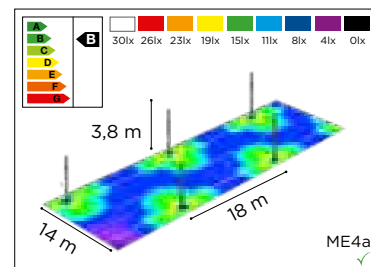
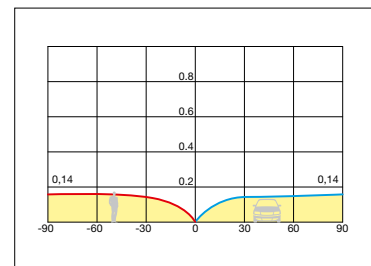
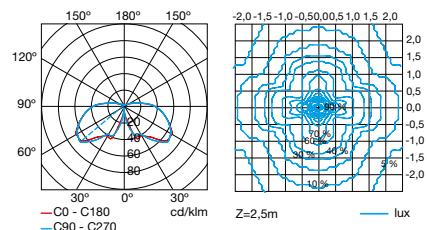

VOSSLOH
ELT



E-27

2 x 70W	HPS - MH	⊕	83-3099-BB-M2 ⁽¹⁾
2 x 70W	HPS	⊕ 2N	83-3103-BB-M2 ⁽¹⁾
2 x 70W	HPS	⊕ 2N TEMP	83-3117-BB-M2 ⁽¹⁾
2 x 70W	HPS - MH	□	83-3184-BB-M2 ⁽¹⁾

E-40

2 x 100W	HPS - MH	⊕	83-3101-BB-M2 ⁽¹⁾
2 x 100W	HPS	⊕ 2N	83-3104-BB-M2 ⁽¹⁾
2 x 100W	HPS	⊕ 2N TEMP	83-3118-BB-M2 ⁽¹⁾
2 x 100W	HPS - MH	□	83-3185-BB-M2 ⁽¹⁾
2 x 150W	HPS - MH	⊕	83-3102-BB-M2 ⁽¹⁾
2 x 150W	HPS	⊕ 2N	83-3105-BB-M2 ⁽¹⁾
2 x 150W	HPS	⊕ 2N TEMP	83-3119-BB-M2 ⁽¹⁾
2 x 150W	HPS - MH	□	83-3186-BB-M2 ⁽¹⁾

- ⁽¹⁾ EL CÓDIGO INCLUYE CABEZAL Y COLUMNA.
- ⁽²⁾ THE CODE INCLUDES HEAD AND POLE.
- ⁽³⁾ LE CODE COMPREND LA TÊTE ET LE MÂT.
- ⁽⁴⁾ DIESE ARTIKEL-NR. ENTHÄLT DEN MAST UND DEN LEUCHTENKOPF.
- ⁽⁵⁾ IL CODICE INCLUDE TESTA E COLONNA.
- ⁽⁶⁾ O CÓDIGO INCLUI A CABEÇA E A COLUNA.
- ⁽⁷⁾ АРТИКУЛ ВКЛЮЧАЕТ СВЕТИЛЬНИК И ОПОРУ.
- ⁽⁸⁾ TEN KOD OBEJMUJE GŁÓWICĘ I SŁUP.



71-4521-48-48

71-4526-48-48

71-3148-48-48



OUTDOOR | URBAN

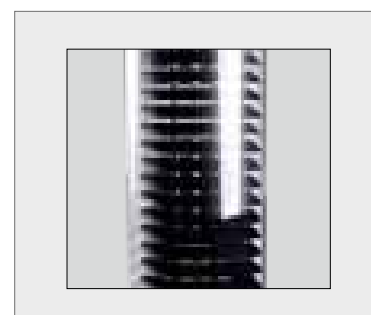

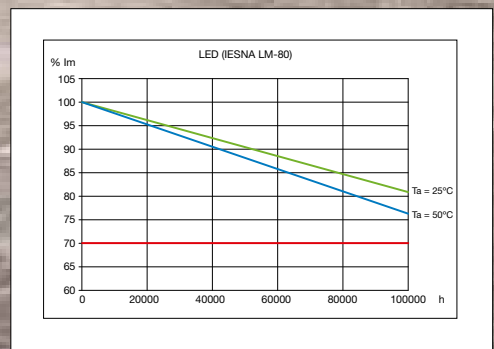

MERIDIAN LED

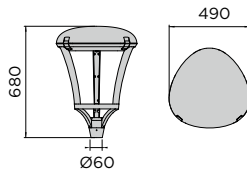

LED 45W
ULOR INST = 0,00%

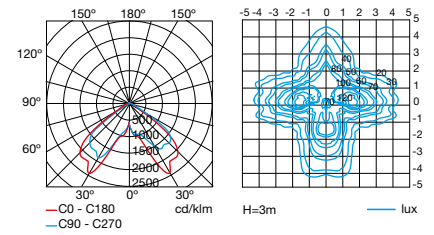

MEAN WELL



LED OSRAM Neutral white 4000K

30W	16 LED	3.103 lm ^(N)	80-4562-BP-37
45W	20 LED	4.283 lm ^(N)	80-4529-BP-37
45W	20 LED	4.283 lm ^(N)	80-4566-BP-37
45W	20 LED	4.283 lm ^(N)	80-4567-BP-37
65W	28 LED	5.970 lm ^(N)	80-2926-BP-37

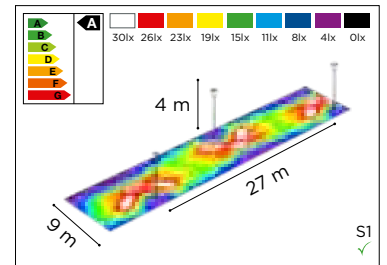
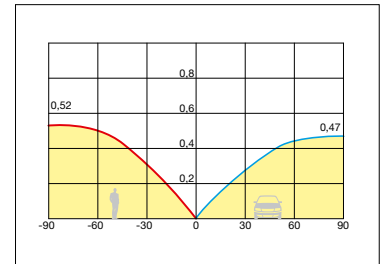

NEW

MERIDIAN LED



LED 45W
ULOR INST = 0,00%

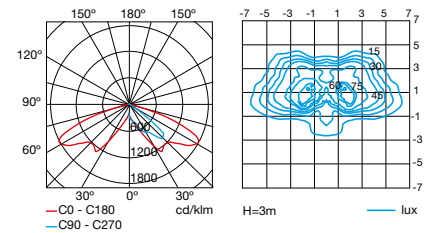

MEAN WELL



LED OSRAM Neutral white 4000K

30W	16 LED	3.179 lm ^(N)	80-2426-BP-37
45W	20 LED	4.379 lm ^(N)	80-2427-BP-37
45W	20 LED	4.379 lm ^(N)	80-2428-BP-37
45W	20 LED	4.379 lm ^(N)	80-2429-BP-37
65W	28 LED	6.117 lm ^(N)	80-2927-BP-37

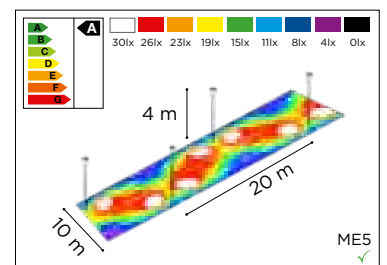
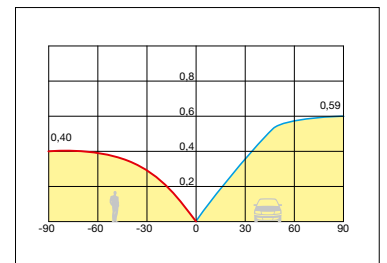

NEW



OUTDOOR | URBAN



PARQUE EUROPA, MADRID, SPAIN

MERIDIAN HID

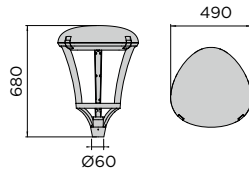

HPS 70W
ULOR INST = 0,1%

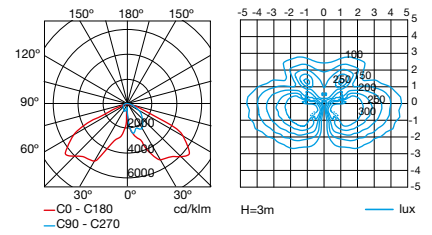

VOSSLOH
ELT

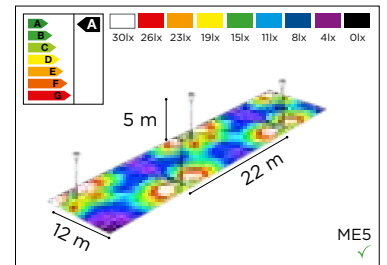
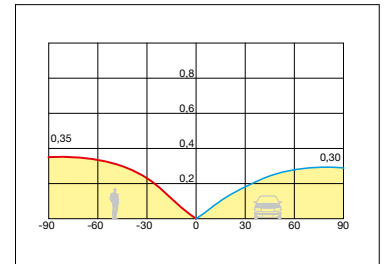
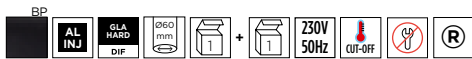

E-27

35W	MH	☉	80-4629-BP-37
35W	MH	☐	80-4630-BP-37
70W	HPS - MH	☉	80-4631-BP-37
70W	HPS	☉ 2N	80-4632-BP-37
70W	HPS	☉ 2N TEMP	80-4633-BP-37
70W	HPS - MH	☐	80-4634-BP-37
70W	HPS	☐ 2N	80-4635-BP-37
70W	HPS	☐ 2N TEMP	80-4636-BP-37

E-40

100W	HPS - MH	☉	80-4637-BP-37
100W	HPS	☉ 2N	80-4638-BP-37
100W	HPS	☉ 2N TEMP	80-4639-BP-37
100W	HPS - MH	☐	80-4640-BP-37
100W	HPS	☐ 2N	80-4641-BP-37
100W	HPS	☐ 2N TEMP	80-4642-BP-37
150W	HPS - MH	☉	80-4643-BP-37
150W	HPS	☉ 2N	80-4644-BP-37
150W	HPS	☉ 2N TEMP	80-4645-BP-37
150W	HPS - MH	☐	80-4647-BP-37
150W	HPS	☐ 2N	80-4646-BP-37
150W	HPS	☐ 2N TEMP	80-4648-BP-37

G-12

70W	MH	☉	80-4786-BP-37
70W	MH	☐	80-4787-BP-37
100W	MH	☉	80-4788-BP-37
100W	MH	☐	80-4789-BP-37
150W	MH	☉	80-4790-BP-37
150W	MH	☐	80-4791-BP-37

PGZ-12

45W	COSMOWHITE	PHILIPS	230V 50-60Hz	☉	80-4626-BP-37
60W	COSMOWHITE	PHILIPS	230V 50-60Hz	☉	80-4627-BP-37
90W	COSMOWHITE	PHILIPS	230V 50-60Hz	☉	80-4628-BP-37

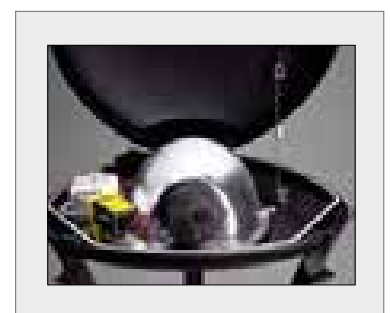

OUTDOOR | URBAN

MERIDIAN HID

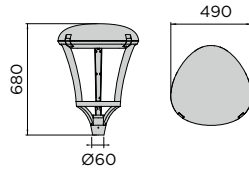

HPS 70W
ULOR INST = 0,1%

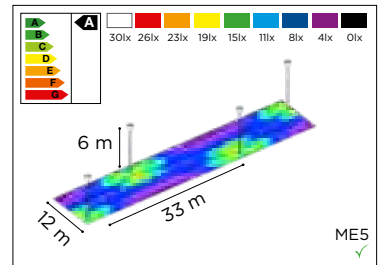
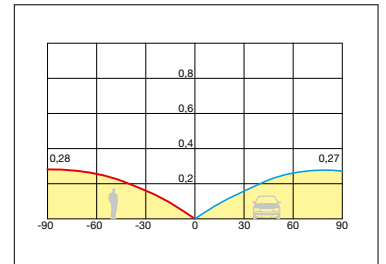
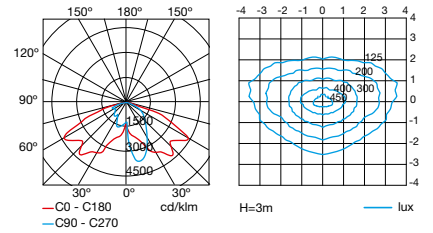

VOSSLOH
ELT

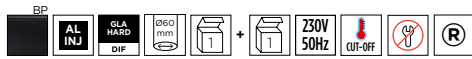

E-27

35W	MH		80-4523-BP-37
35W	MH		80-4524-BP-37
70W	HPS - MH		80-3012-BP-37
70W	HPS		80-3015-BP-37
70W	HPS		80-3018-BP-37
70W	HPS - MH		80-3021-BP-37
70W	HPS		80-3025-BP-37
70W	HPS		80-3179-BP-37

E-40

100W	HPS - MH		80-3013-BP-37
100W	HPS		80-3016-BP-37
100W	HPS		80-3019-BP-37
100W	HPS - MH		80-3022-BP-37
100W	HPS - MH		80-3026-BP-37
100W	HPS		80-3180-BP-37
150W	HPS - MH		80-3014-BP-37
150W	HPS		80-3017-BP-37
150W	HPS		80-3020-BP-37
150W	HPS - MH		80-3042-BP-37
150W	HPS		80-3027-BP-37
150W	HPS		80-3181-BP-37

G-12

70W	MH		80-4779-BP-37
70W	MH		80-4780-BP-37
100W	MH		80-4781-BP-37
100W	MH		80-4782-BP-37
150W	MH		80-4783-BP-37
150W	MH		80-4784-BP-37

PGZ-12

45W	COSMOWHITE	PHILIPS	80-4592-BP-37
60W	COSMOWHITE	PHILIPS	80-4593-BP-37
90W	COSMOWHITE	PHILIPS	80-4594-BP-37

MERIDIAN SOLAR

ASYMMETRICAL **NEW**

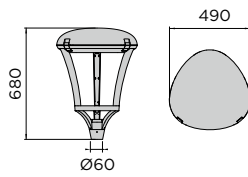

LED 45W
ULOR INST = 0,00%

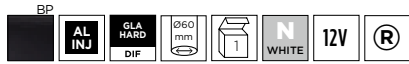
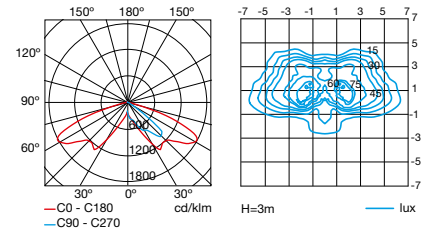

LED OSRAM Neutral white 4000K

30W	20 LED	3.179 lm ^(N)	80-3257-BP-37
45W	20 LED	4.379 lm ^(N)	80-3258-BP-37
65W	28 LED	6.117 lm ^(N)	80-3275-BP-37

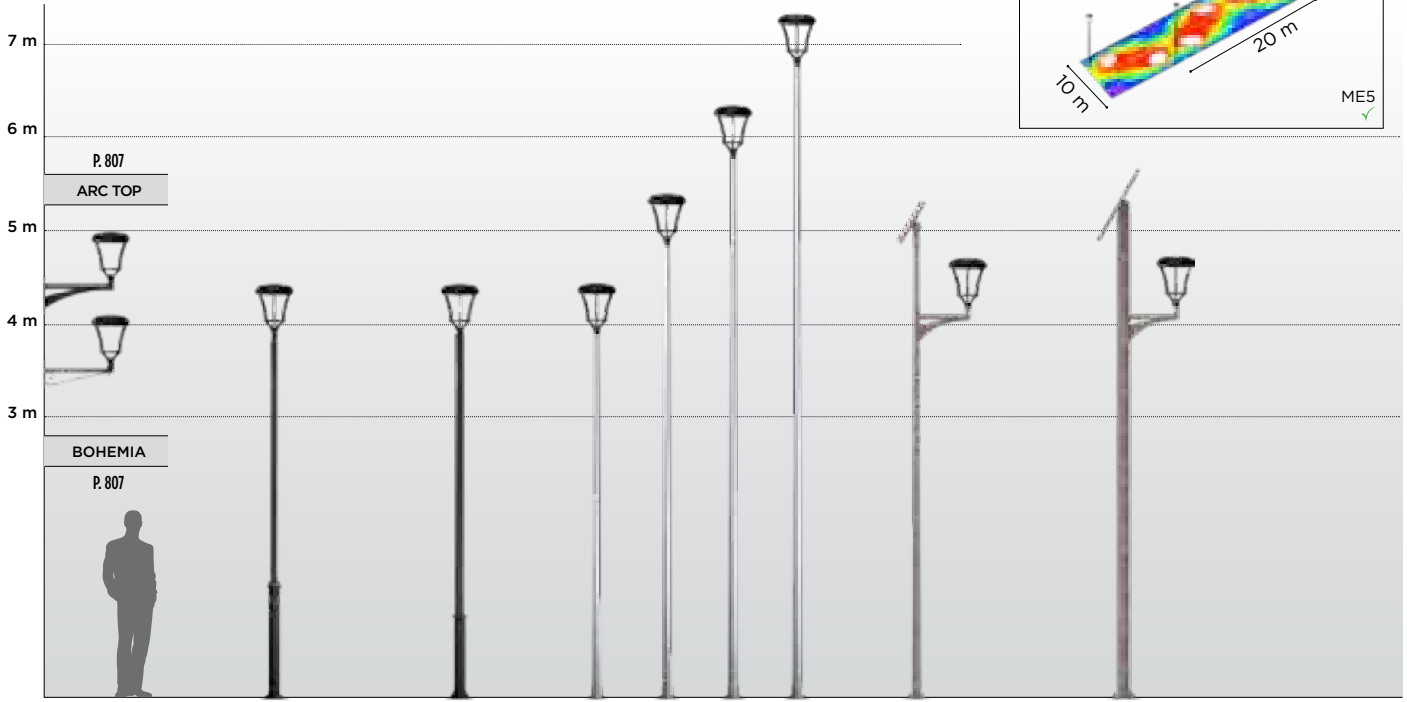
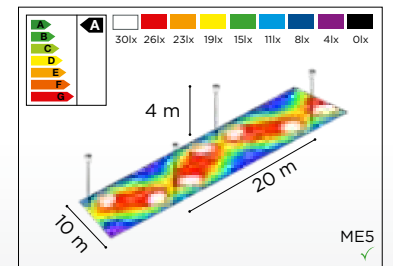
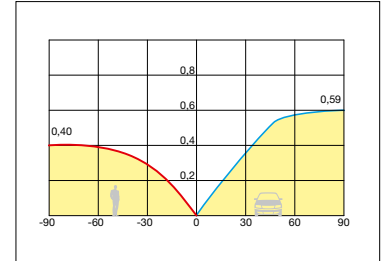

BOHEMIA	NIKOLSON	CONICAL	SOLAR-ECO TOP	SOLAR-TECH TOP
P. 805	P. 804	P. 801	P. 800	P. 800

BOHEMIA	4m	81-3123-BP-BP	■	71-4521-48-48	71-4524-48-48	✓	X	71-3148-48-48	X
NIKOLSON	4m	81-3145-BP-BP	■	71-4520-48-48	71-4524-48-48	✓	X	71-3128-48-48	X
CONICAL	7m	81-3149-AV-AV	▨	71-4540-48-48	71-4525-48-48	✓	X	71-4531-48-48	X
	6m	81-4535-AV-AV	▨	71-4539-48-48	71-4524-48-48	✓	X	71-4531-48-48	X
	5m	81-4534-AV-AV	▨	71-4539-48-48	71-4524-48-48	✓	X	71-4531-48-48	X
	4m	81-3151-AV-AV	▨	71-4520-48-48	71-4524-48-48	✓	X	71-4531-48-48	X
SOLAR-ECO TOP	5m	81-3256-AV-AV	■	71-4539-48-48	71-4524-48-48	✓	X	71-4531-48-48	P. 798
SOLAR-TECH TOP	5m	81-3255-AV-AV	■	71-4521-48-48	71-4525-48-48	✓	X	71-4531-48-48	P. 799
ARC TOP	ARM	82-3012-BP-BP	■						
BOHEMIA	ARM	82-3124-BP-BP	■						

OUTDOOR | URBAN

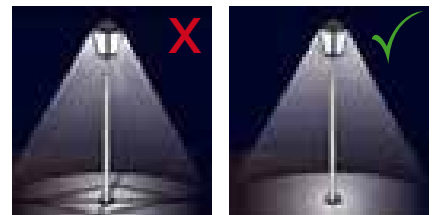
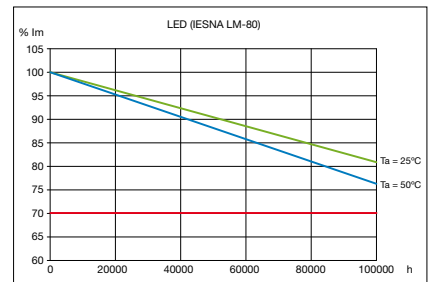

SISTEMA EXCLUSIVO DE LEDS-C4 PARA REDUCIR LA PROYECCIÓN DE SOMBRAS.

EXCLUSIVE LEDS-C4 SYSTEM TO REDUCE SHADOWS.

SYSTÈME EXCLUSIF DE LEDS-C4 DESTINÉ À RÉDUIRE LA PROJECTION D'OMBRES.

EXKLUSIVES SYSTEM VON LEDS-C4 ZUR VERRINGERUNG VON SCHATTENWURF.

SISTEMA ESCLUSIVO DI LEDS-C4 PER RIDURRE LA PROIEZIONE DI OMBRE.

SISTEMA EXCLUSIVO DE LEDS-C4 PARA REDUZIR A PROJEÇÃO DE SOMBRAS.

ЭКСКЛЮЗИВНАЯ СИСТЕМА LEDS-C4 ДЛЯ УМЕНЬШЕНИЯ ОТБРАСЫВАНИЯ ТЕНЕЙ.

EKSKLUZYWNY SYSTEM LEDS-C4 DLA ZMNIEJSZENIA RZUCANIA CIENI.

BOHEMIA LED

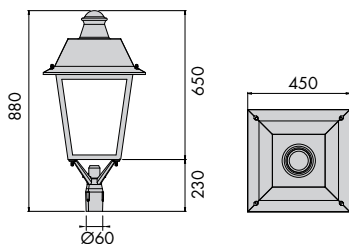

MEAN WELL

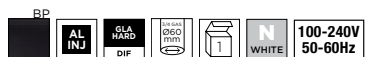

LED OSRAM Neutral white 4000K

30W	16 LED	3.102 lm ^(N)	80-4538-BP-37
45W	20 LED	4.283 lm ^(N)	80-4528-BP-37
45W	20 LED	4.283 lm ^(N)	80-4543-BP-37
45W	20 LED	4.283 lm ^(N)	80-4542-BP-37
65W	28 LED	5.970 lm ^(N)	80-8928-BP-37

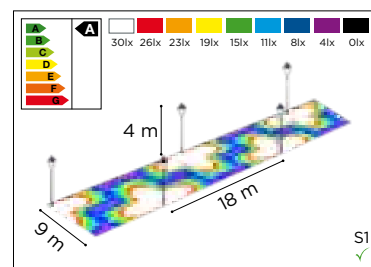
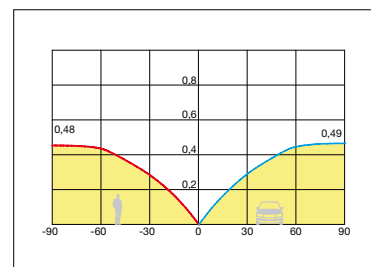
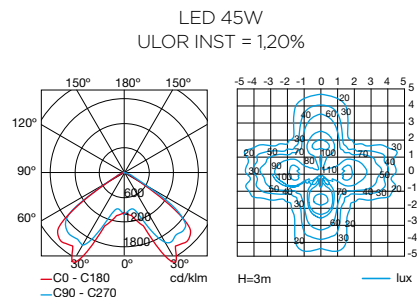

NEW

BOHEMIA LED

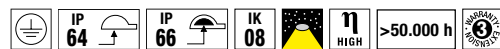
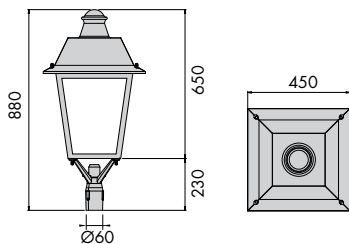

MEAN WELL



LED OSRAM Neutral white 4000K

30W	16 LED	3.179 lm ^(N)	80-2417-BP-37
45W	20 LED	4.379 lm ^(N)	80-2418-BP-37
45W	20 LED	4.379 lm ^(N)	80-2421-BP-37
45W	20 LED	4.379 lm ^(N)	80-2419-BP-37
65W	28 LED	6.117 lm ^(N)	80-8929-BP-37

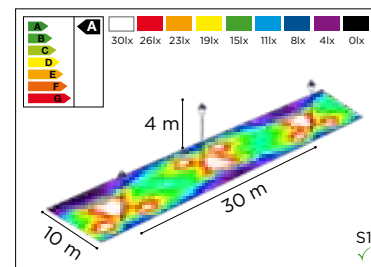
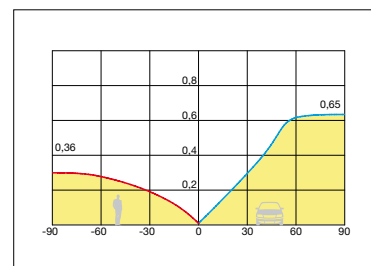
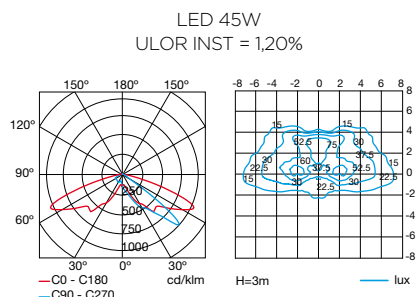

NEW



OUTDOOR | URBAN



BOHEMIA HID

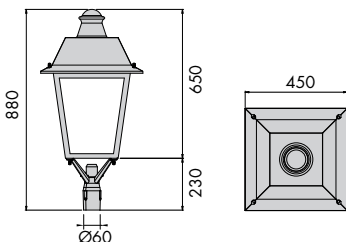

VOSSLOH
ELT



E-27

35W	MH		80-4652-BP-37
35W	MH		80-4653-BP-37
70W	HPS-MH		80-4654-BP-37
70W	HPS	2N	80-4655-BP-37
70W	HPS	2N TEMP	80-4656-BP-37
70W	HPS-MH		80-4657-BP-37
70W	HPS	2N	80-4658-BP-37
70W	HPS	2N TEMP	80-4659-BP-37

E-40

100W	HPS-MH		80-4660-BP-37
100W	HPS	2N	80-4661-BP-37
100W	HPS	2N TEMP	80-4662-BP-37
100W	HPS-MH		80-4663-BP-37
100W	HPS	2N	80-4664-BP-37
100W	HPS	2N TEMP	80-4665-BP-37
150W	HPS-MH		80-4666-BP-37
150W	HPS	2N	80-4667-BP-37
150W	HPS	2N TEMP	80-4668-BP-37
150W	HPS-MH		80-4669-BP-37
150W	HPS	2N	80-4670-BP-37
150W	HPS	2N TEMP	80-4671-BP-37

G-12

70W	MH		80-4799-BP-37
70W	MH		80-4800-BP-37
100W	MH		80-4801-BP-37
100W	MH		80-4802-BP-37
150W	MH		80-4803-BP-37
150W	MH		80-4804-BP-37

PGZ-12

45W	COSMOWHITE		PHILIPS	230V 50-60Hz		80-4649-BP-37
60W	COSMOWHITE		PHILIPS	230V 50-60Hz		80-4650-BP-37
90W	COSMOWHITE		PHILIPS	230V 50-60Hz		80-4651-BP-37

HPS 70W
ULOR INST = 1,00%

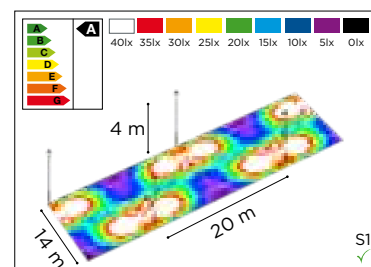
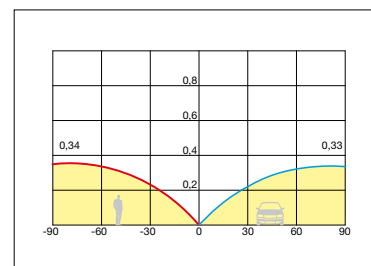
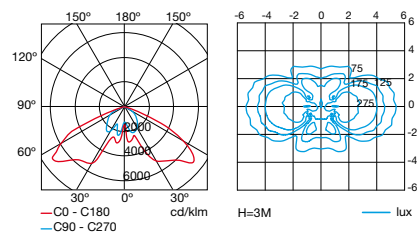

OUTDOOR | URBAN

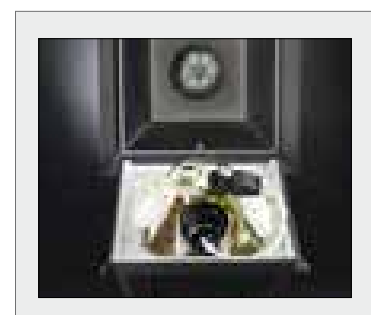

BOHEMIA HID

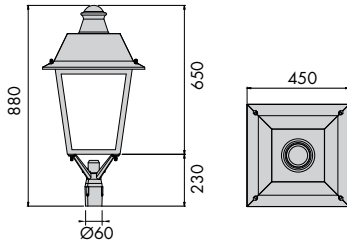

HPS 70W
ULOR INST = 1.00%

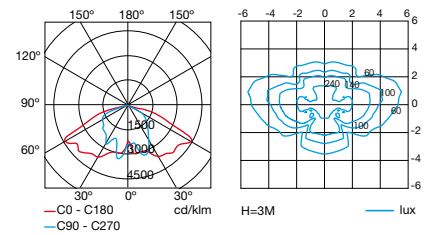

VOSSLOH
ELT

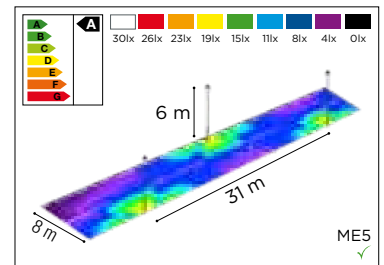
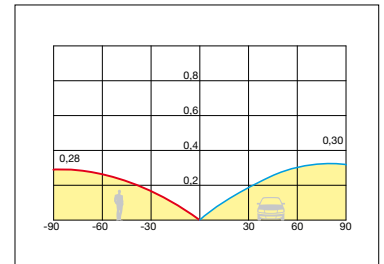

E-27

35W	MH		80-4525-BP-37
35W	MH		80-4545-BP-37
70W	HPS-MH		80-3001-BP-37
70W	HPS	2N	80-3004-BP-37
70W	HPS	2N TEMP	80-3007-BP-37
70W	HPS-MH		80-3010-BP-37
70W	HPS	2N	80-3173-BP-37
70W	HPS	2N TEMP	80-3176-BP-37

E-40

100W	HPS-MH		80-3002-BP-37
100W	HPS	2N	80-3005-BP-37
100W	HPS	2N TEMP	80-3008-BP-37
100W	HPS-MH		80-3011-BP-37
100W	HPS	2N	80-3174-BP-37
100W	HPS	2N TEMP	80-3177-BP-37
150W	HPS-MH		80-3003-BP-37
150W	HPS	2N	80-3006-BP-37
150W	HPS	2N TEMP	80-3009-BP-37
150W	HPS-MH		80-3028-BP-37
150W	HPS	2N	80-3175-BP-37
150W	HPS	2N TEMP	80-3178-BP-37

G-12

70W	MH		80-4793-BP-37
70W	MH		80-4794-BP-37
100W	MH		80-4795-BP-37
100W	MH		80-4796-BP-37
150W	MH		80-4797-BP-37
150W	MH		80-4798-BP-37

PGZ-12

45W	COSMOWHITE	PHILIPS	230V 50-60Hz		80-4595-BP-37
60W	COSMOWHITE	PHILIPS	230V 50-60Hz		80-4596-BP-37
90W	COSMOWHITE	PHILIPS	230V 50-60Hz		80-4597-BP-37

BOHEMIA SOLAR



NEW

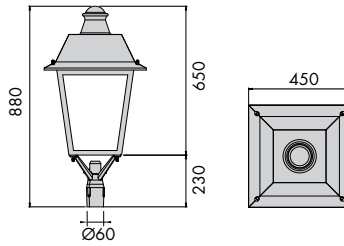

LED 45W
ULOR INST = 1,20%

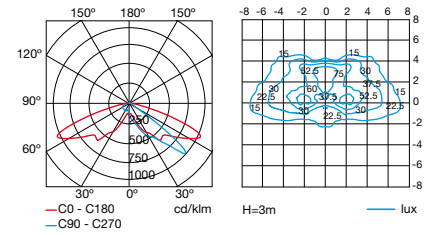

LED OSRAM Neutral white 4000K

30W	20 LED	3.179 lm ^(N)	80-3261-BP-37
45W	20 LED	4.379 lm ^(N)	80-3262-BP-37
65W	28 LED	6.117 lm ^(N)	80-3276-BP-37

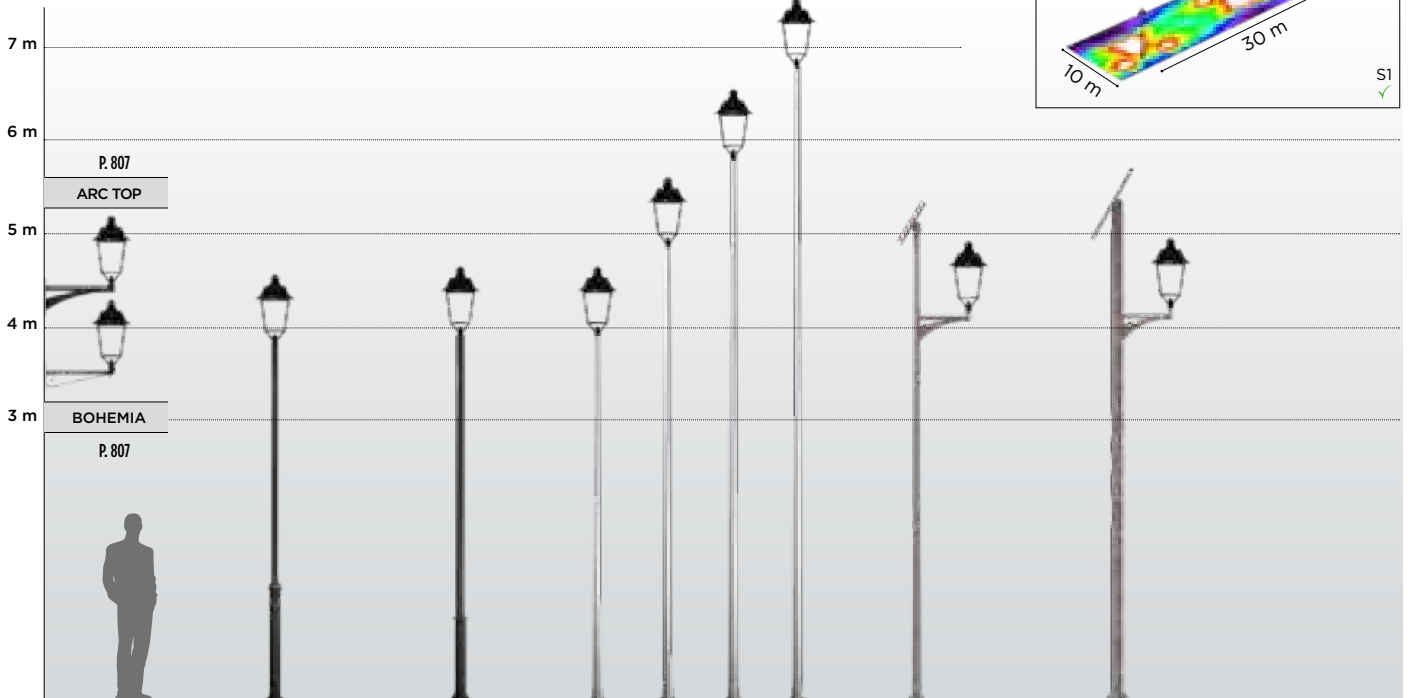
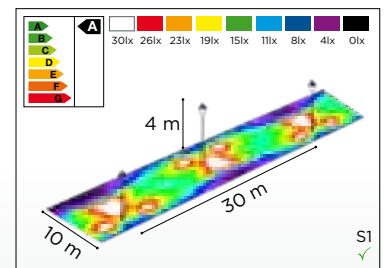
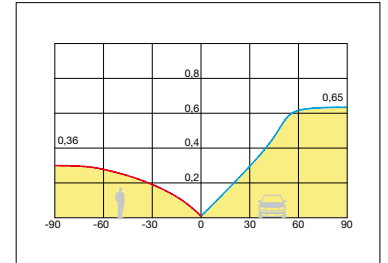

BOHEMIA P. 805 NIKOLSON P. 804 CONICAL P. 801 SOLAR-ECO TOP P. 800 SOLAR-TECH TOP P. 800



Model	Height	Code	Color	Code	Code	✓	X	Code	X
BOHEMIA	4m	81-3123-BP-BP	■	71-4521-48-48	71-4524-48-48	✓	X	71-3148-48-48	X
NIKOLSON	4m	81-3145-BP-BP	■	71-4520-48-48	71-4524-48-48	✓	X	71-3128-48-48	X
CONICAL	7m	81-3149-AV-AV	▨	71-4540-48-48	71-4525-48-48	✓	X	71-4531-48-48	X
	6m	81-4535-AV-AV	▨	71-4539-48-48	71-4524-48-48	✓	X	71-4531-48-48	X
	5m	81-4534-AV-AV	▨	71-4539-48-48	71-4524-48-48	✓	X	71-4531-48-48	X
	4m	81-3151-AV-AV	▨	71-4520-48-48	71-4524-48-48	✓	X	71-4531-48-48	X
SOLAR-ECO TOP	5m	81-3256-AV-AV	■	71-4539-48-48	71-4524-48-48	✓	X	71-4531-48-48	P. 798
SOLAR-TECH TOP	5m	81-3255-AV-AV	■	71-4521-48-48	71-4525-48-48	✓	X	71-4531-48-48	P. 799
ARC TOP	ARM	82-3012-BP-BP	■						
BOHEMIA	ARM	82-3124-BP-BP	■						

OUTDOOR | URBAN

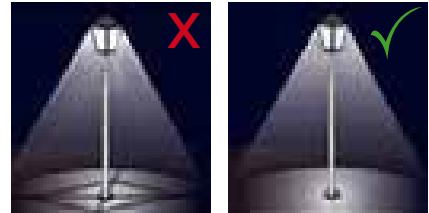
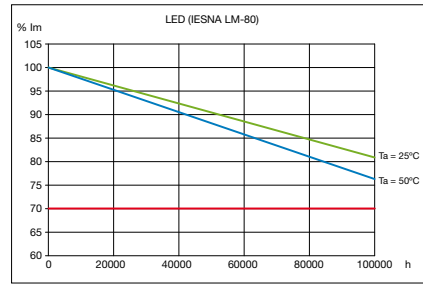
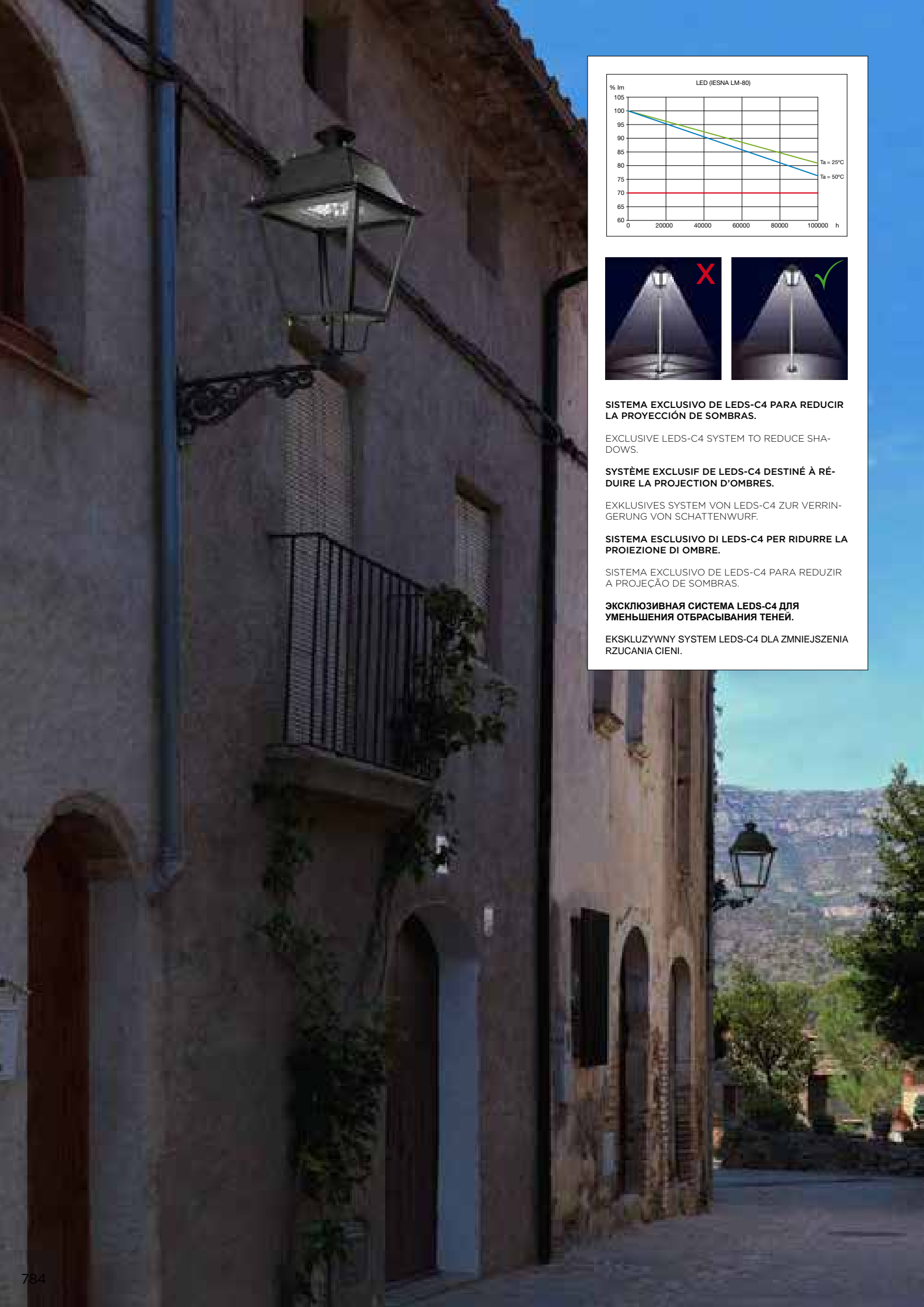

SISTEMA EXCLUSIVO DE LEDS-C4 PARA REDUCIR LA PROYECCIÓN DE SOMBRAS.

EXCLUSIVE LEDS-C4 SYSTEM TO REDUCE SHADOWS.

SYSTÈME EXCLUSIF DE LEDS-C4 DESTINÉ À RÉDUIRE LA PROJECTION D'OMBRES.

EXKLUSIVES VON LEDS-C4 ZUR VERRINGERUNG VON SCHATTENWURF.

SISTEMA ESCLUSIVO DI LEDS-C4 PER RIDURRE LA PROIEZIONE DI OMBRE.

SISTEMA EXCLUSIVO DE LEDS-C4 PARA REDUZIR A PROJEÇÃO DE SOMBRAS.

ЭКСКЛЮЗИВНАЯ СИСТЕМА LEDS-C4 ДЛЯ УМЕНЬШЕНИЯ ОТБРАСЫВАНИЯ ТЕНЕЙ.

EKSKLUZYWNY SYSTEM LEDS-C4 DLA ZMNIEJSZENIA RZUCANIA CIENI.

ANDALUCIA LED

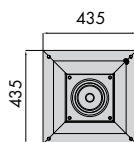
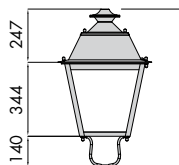

MEAN WELL



LED OSRAM Neutral white 4000K

30W	16 LED	3.103 lm ^(N)		80-4692-BP-37
45W	20 LED	4.283 lm ^(N)		80-4520-BP-37
45W	20 LED	4.283 lm ^(N)	2N	80-4698-BP-37
45W	20 LED	4.283 lm ^(N)	2N TEMP	80-4697-BP-37
60W	28 LED	5.970 lm ^(N)		80-8930-BP-37

LED 45W
ULOR INST = 1,20%

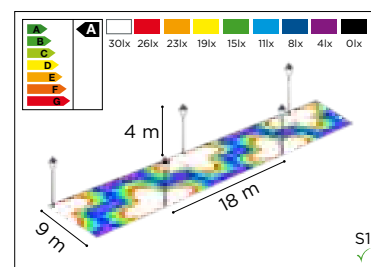
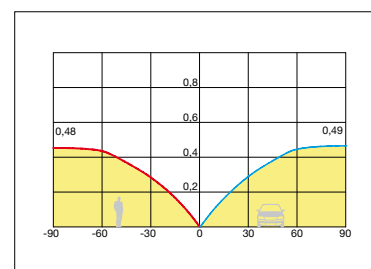
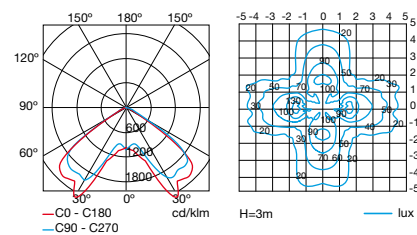

NEW



OUTDOOR | URBAN

ANDALUCIA LED

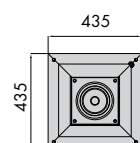
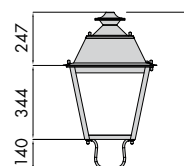

MEAN WELL



LED OSRAM Neutral white 4000K

30W	16 LED	3.179 lm ^(N)		80-2422-BP-37
45W	20 LED	4.378 lm ^(N)		80-2423-BP-37
45W	20 LED	4.378 lm ^(N)	2N	80-2425-BP-37
45W	20 LED	4.378 lm ^(N)	2N TEMP	80-2424-BP-37
60W	28 LED	6.117 lm ^(N)		80-8931-BP-37

LED 45W
ULOR INST = 1,20%

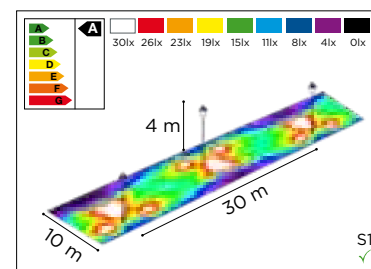
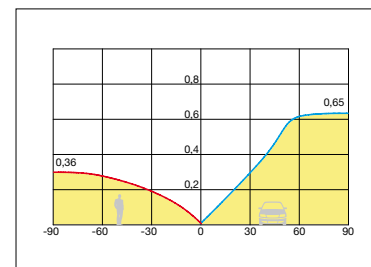
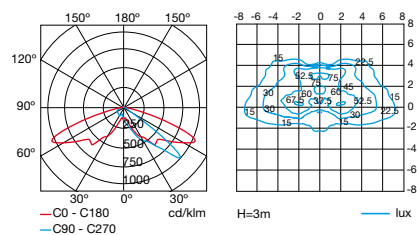

NEW



ANDALUCIA HID

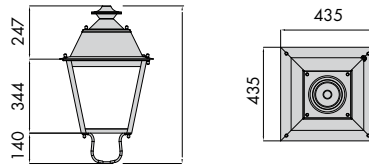

HPS 70W
ULOR INST = 1,00%

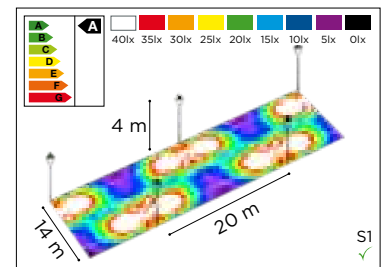
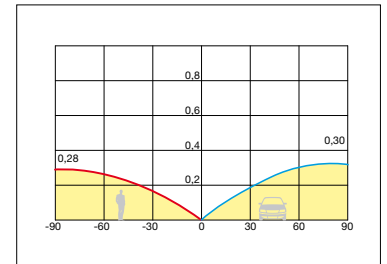
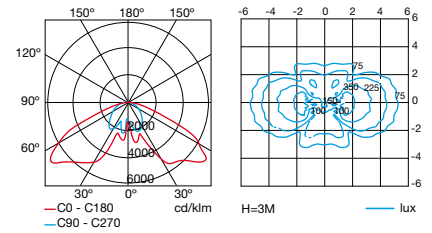

VOSSLOH
ELT

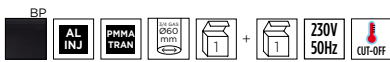

E-27

WITHOUT GEAR			
35W	MH		80-4773-BP-37
35W	MH		80-4672-BP-37
70W	HPS-MH		80-4673-BP-37
70W	HPS		80-4674-BP-37
70W	HPS	2N	80-4675-BP-37
70W	HPS	2N	80-4676-BP-37
70W	HPS-MH		80-4677-BP-37
70W	HPS	2N	80-4678-BP-37
70W	HPS	2N	80-4679-BP-37

E-40

WITHOUT GEAR			
100W	HPS-MH		80-4769-BP-37
100W	HPS	2N	80-4680-BP-37
100W	HPS	2N	80-4681-BP-37
100W	HPS-MH		80-4682-BP-37
100W	HPS	2N	80-4683-BP-37
100W	HPS	2N	80-4684-BP-37
100W	HPS	2N	80-4685-BP-37
150W	HPS-MH		80-4686-BP-37
150W	HPS	2N	80-4687-BP-37
150W	HPS	2N	80-4688-BP-37
150W	HPS-MH		80-4689-BP-37
150W	HPS	2N	80-4690-BP-37
150W	HPS	2N	80-4691-BP-37

G-12

70W	MH		80-4811-BP-37
70W	MH		80-4812-BP-37
100W	MH		80-4813-BP-37
100W	MH		80-4814-BP-37
150W	MH		80-4815-BP-37
150W	MH		80-4816-BP-37



OUTDOOR | URBAN

ANDALUCIA HID

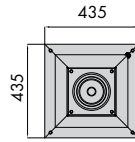
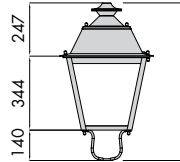

HPS 70W
ULOR INST = 1,00%

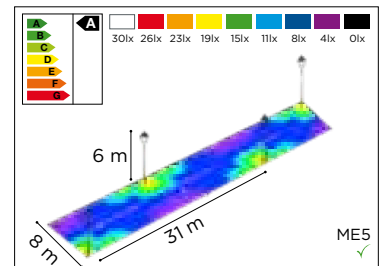
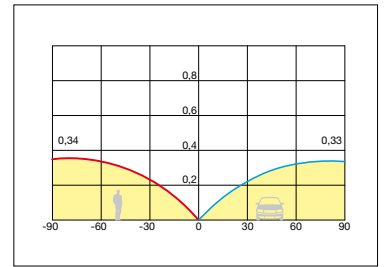
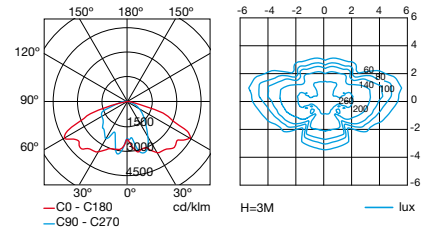

VOSSLOH
ELT

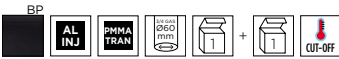

E-27

WITHOUT GEAR

35W MH		80-4772-BP-37
35W MH		80-4569-BP-37
70W HPS-MH		80-4570-BP-37
70W HPS	2N	80-4470-BP-37
70W HPS	2N TEMP	80-4473-BP-37
70W HPS	2N TEMP	80-4476-BP-37
70W HPS-MH		80-4479-BP-37
70W HPS	2N	80-4482-BP-37
70W HPS	2N TEMP	80-4485-BP-37

E-40

WITHOUT GEAR

100W HPS-MH		80-4492-BP-37
100W HPS	2N	80-4471-BP-37
100W HPS	2N TEMP	80-4474-BP-37
100W HPS	2N TEMP	80-4477-BP-37
100W HPS-MH		80-4480-BP-37
100W HPS	2N	80-4483-BP-37
100W HPS	2N TEMP	80-4486-BP-37
150W HPS-MH		80-4472-BP-37
150W HPS	2N	80-4475-BP-37
150W HPS	2N TEMP	80-4478-BP-37
150W HPS-MH		80-4481-BP-37
150W HPS	2N	80-4484-BP-37
150W HPS	2N TEMP	80-4487-BP-37

G-12

70W MH		80-4805-BP-37
70W MH		80-4806-BP-37
100W MH		80-4807-BP-37
100W MH		80-4808-BP-37
150W MH		80-4809-BP-37
150W MH		80-4810-BP-37

ANDALUCIA SOLAR



NEW

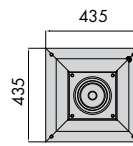
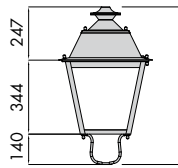

LED 45W
ULOR INST = 1,20%

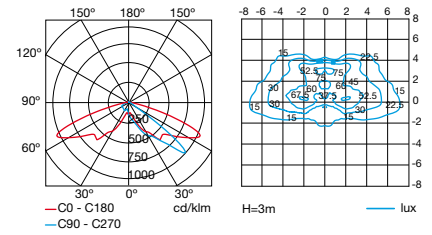

LED OSRAM Neutral white 4000K

30W	20 LED	3.179 lm ^(N)	80-3265-BP-37
45W	20 LED	4.378 lm ^(N)	80-3266-BP-37
65W	28 LED	6.117 lm ^(N)	80-3277-BP-37

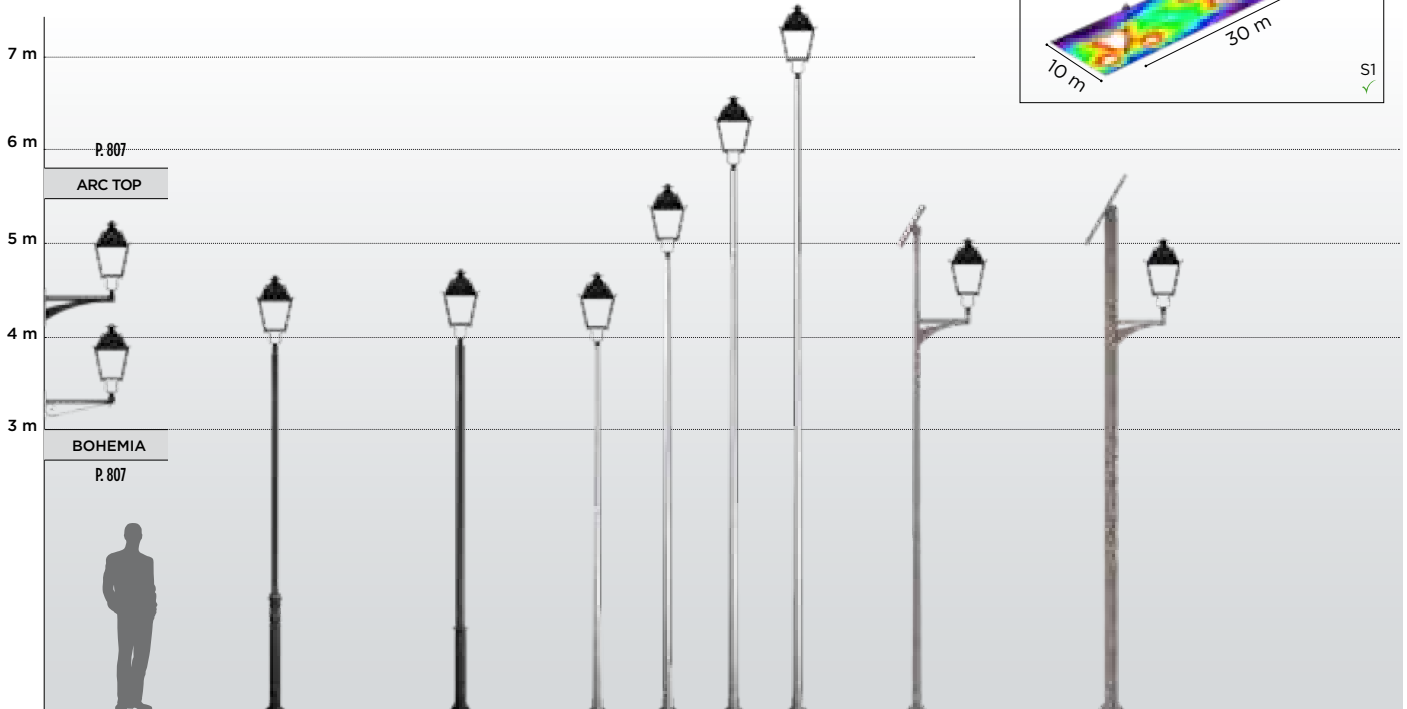
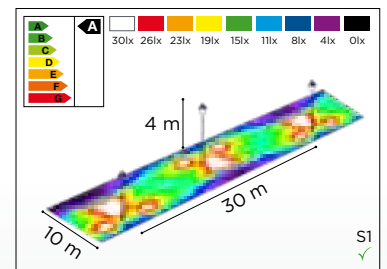
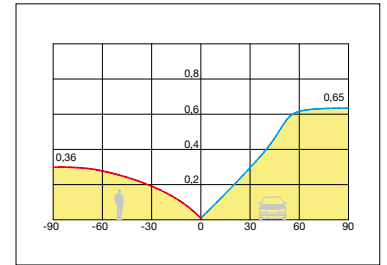

BOHEMIA P. 805 NIKOLSON P. 804 CONICAL P. 801 SOLAR-ECO TOP P. 800 SOLAR-TECH TOP P. 800



Model	Height	Code 1	Code 2	Code 3	Code 4	Code 5	Code 6	Code 7	Code 8	Code 9
BOHEMIA	4m	81-3123-BP-BP	71-4521-48-48	71-4524-48-48	71-4470-BP-BP	71-3148-48-48	71-3128-48-48	71-4531-48-48	71-4531-48-48	X
NIKOLSON	4m	81-3145-BP-BP	71-4520-48-48	71-4524-48-48	71-4470-BP-BP	71-3128-48-48	71-4531-48-48	71-4531-48-48	71-4531-48-48	X
CONICAL	7m	81-3149-AV-AV	71-4540-48-48	71-4525-48-48	71-4470-BP-BP	71-4531-48-48	71-4531-48-48	71-4531-48-48	71-4531-48-48	X
	6m	81-4535-AV-AV	71-4539-48-48	71-4524-48-48	71-4470-BP-BP	71-4531-48-48	71-4531-48-48	71-4531-48-48	71-4531-48-48	X
	5m	81-4534-AV-AV	71-4539-48-48	71-4524-48-48	71-4470-BP-BP	71-4531-48-48	71-4531-48-48	71-4531-48-48	71-4531-48-48	X
	4m	81-3151-AV-AV	71-4520-48-48	71-4524-48-48	71-4470-BP-BP	71-4531-48-48	71-4531-48-48	71-4531-48-48	71-4531-48-48	X
SOLAR-ECO TOP	5m	81-3256-AV-AV	71-4539-48-48	71-4524-48-48	71-4470-BP-BP	71-4531-48-48	71-4531-48-48	71-4531-48-48	71-4531-48-48	P. 798
SOLAR-TECH TOP	5m	81-3255-AV-AV	71-4521-48-48	71-4525-48-48	71-4470-BP-BP	71-4531-48-48	71-4531-48-48	71-4531-48-48	71-4531-48-48	P. 799
ARC TOP	ARM	82-3012-BP-BP			71-4470-BP-BP					
BOHEMIA	ARM	82-3124-BP-BP			71-4470-BP-BP					



OUTDOOR | URBAN

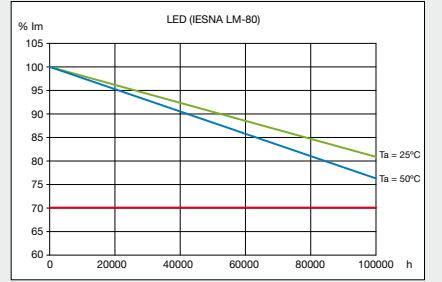
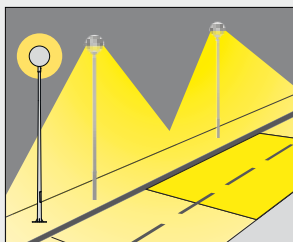

NEOBOLA LED

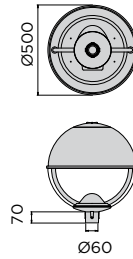

MEAN WELL



LED OSRAM Neutral white 4000K

30W	16 LED	3.103 lm ^(N)		80-2434-AU-M2
45W	20 LED	4.283 lm ^(N)		80-2435-AU-M2
45W	20 LED	4.283 lm ^(N)	ZN	80-2437-AU-M2
45W	20 LED	4.283 lm ^(N)	ZN TEMP	80-2436-AU-M2
65W	28 LED	5.970 lm ^(N)		80-8932-AU-M2

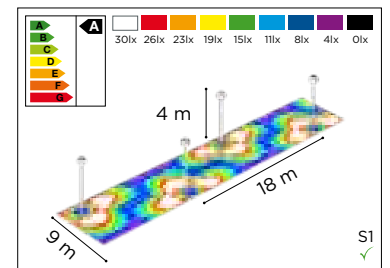
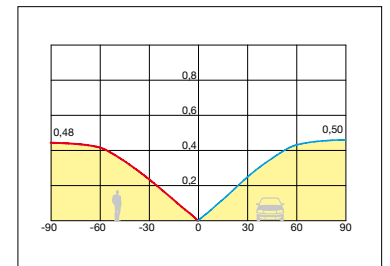
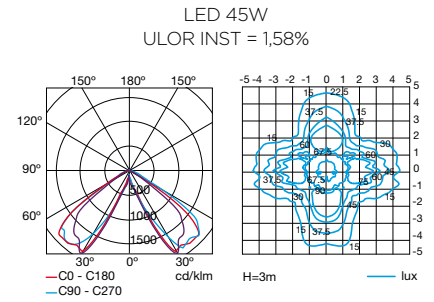

NEW



OUTDOOR | URBAN

NEOBOLA LED

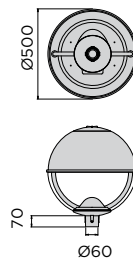

MEAN WELL



LED OSRAM Neutral white 4000K

30W	16 LED	3.179 lm ^(N)		80-2430-AU-M2
45W	20 LED	4.379 lm ^(N)		80-2431-AU-M2
45W	20 LED	4.379 lm ^(N)	ZN	80-2433-AU-M2
45W	20 LED	4.379 lm ^(N)	ZN TEMP	80-2432-AU-M2
65W	28 LED	6.117 lm ^(N)		80-8933-AU-M2

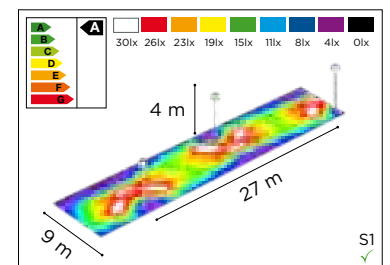
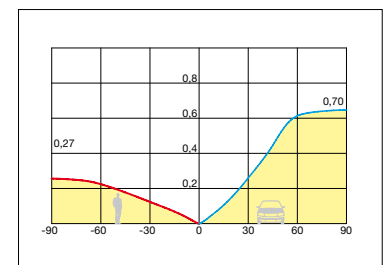
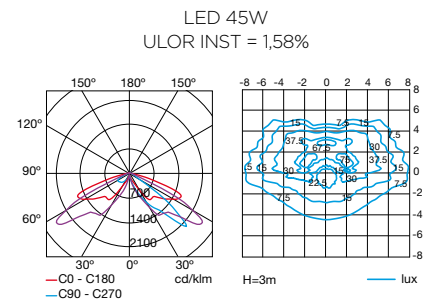

NEW



NEOBOLA HID

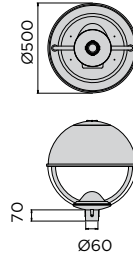

HPS 70W
ULOR INST = 1,58%

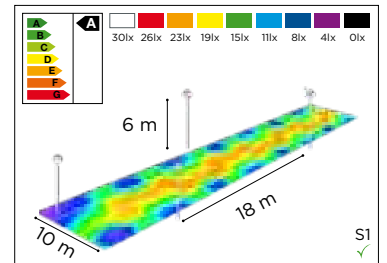
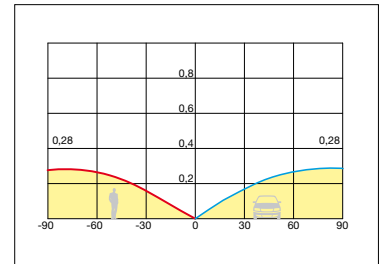
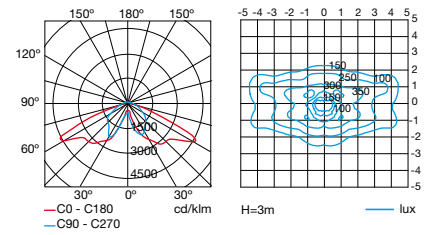

VOSSLOH
ELT

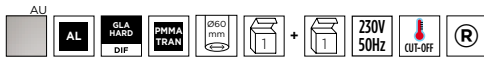

E-27

35W	MH	☉	80-4571-AU-M2
35W	MH	☐	80-4572-AU-M2
70W	HPS - MH	☉	80-3125-AU-M2
70W	HPS	☉ 2N	80-3129-AU-M2
70W	HPS	☉ 2N TEMP	80-3134-AU-M2
70W	HPS - MH	☐	80-3138-AU-M2
70W	HPS	☐ 2N	80-3142-AU-M2
70W	HPS	☐ 2N TEMP	80-3146-AU-M2

E-40

100W	HPS - MH	☉	80-3126-AU-M2
100W	HPS	☉ 2N	80-3130-AU-M2
100W	HPS	☉ 2N TEMP	80-3135-AU-M2
100W	HPS - MH	☐	80-3139-AU-M2
100W	HPS - MH	☐ 2N	80-3143-AU-M2
100W	HPS	☐ 2N TEMP	80-3147-AU-M2
150W	HPS - MH	☉	80-3127-AU-M2
150W	HPS	☉ 2N	80-3131-AU-M2
150W	HPS	☉ 2N TEMP	80-3136-AU-M2
150W	HPS - MH	☐	80-3141-AU-M2
150W	HPS	☐ 2N	80-3144-AU-M2
150W	HPS	☐ 2N TEMP	80-3149-AU-M2

G-12

70W	MH	☉	80-4817-AU-M2
70W	MH	☐	80-4818-AU-M2
100W	MH	☉	80-4819-AU-M2
100W	MH	☐	80-4820-AU-M2
150W	MH	☉	80-4821-AU-M2
150W	MH	☐	80-4822-AU-M2

PGZ-12

45W	COSMOWHITE	PHILIPS	230V 50-60Hz	☉	80-4605-AU-M2
60W	COSMOWHITE	PHILIPS	230V 50-60Hz	☉	80-4606-AU-M2
90W	COSMOWHITE	PHILIPS	230V 50-60Hz	☉	80-4607-AU-M2



OUTDOOR | URBAN

NEOBOLA HID

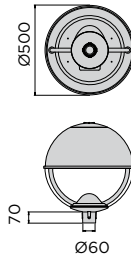

HPS 70W
ULOR INST = 1,58%

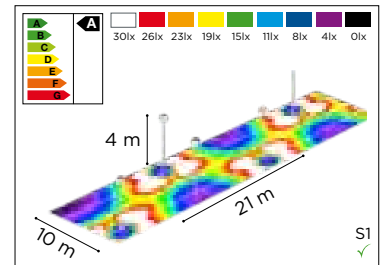
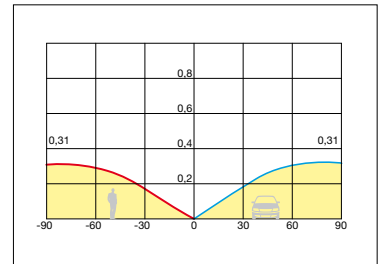
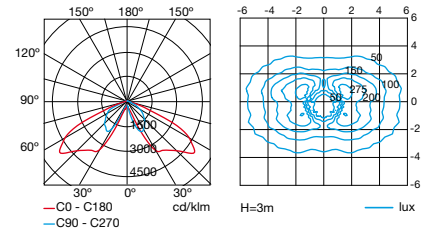

VOSSLOH
ELT

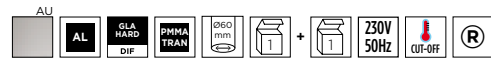

E-27

35W	MH		80-4703-AU-M2
35W	MH		80-4704-AU-M2
70W	HPS - MH		80-4705-AU-M2
70W	HPS	2N	80-4706-AU-M2
70W	HPS	2N	80-4707-AU-M2
70W	HPS - MH		80-4708-AU-M2
70W	HPS	2N	80-4709-AU-M2
70W	HPS	2N	80-4710-AU-M2

E-40

100W	HPS - MH		80-4711-AU-M2
100W	HPS	2N	80-4712-AU-M2
100W	HPS	2N	80-4713-AU-M2
100W	HPS - MH		80-4714-AU-M2
100W	HPS - MH	2N	80-4715-AU-M2
100W	HPS	2N	80-4716-AU-M2
150W	HPS - MH		80-4717-AU-M2
150W	HPS	2N	80-4718-AU-M2
150W	HPS	2N	80-4719-AU-M2
150W	HPS - MH		80-4720-AU-M2
150W	HPS	2N	80-4721-AU-M2
150W	HPS	2N	80-4722-AU-M2

G-12

70W	MH		80-4823-AU-M2
70W	MH		80-4824-AU-M2
100W	MH		80-4825-AU-M2
100W	MH		80-4826-AU-M2
150W	MH		80-4827-AU-M2
150W	MH		80-4828-AU-M2

PGZ-12

45W	COSMOWHITE	PHILIPS			80-4700-AU-M2
60W	COSMOWHITE	PHILIPS			80-4701-AU-M2
90W	COSMOWHITE	PHILIPS			80-4702-AU-M2

NEOBOLA SOLAR



NEW

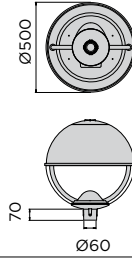

LED 45W
ULOR INST = 1,58%

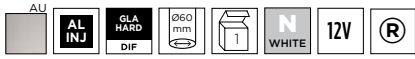
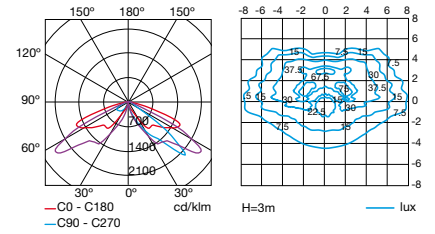

LED OSRAM Neutral white 4000K

30W	20 LED	3.179 lm ^(N)	80-3269-AU-M2
45W	20 LED	4.379 lm ^(N)	80-3270-AU-M2
65W	28 LED	6.117 lm ^(N)	80-3278-AU-M2

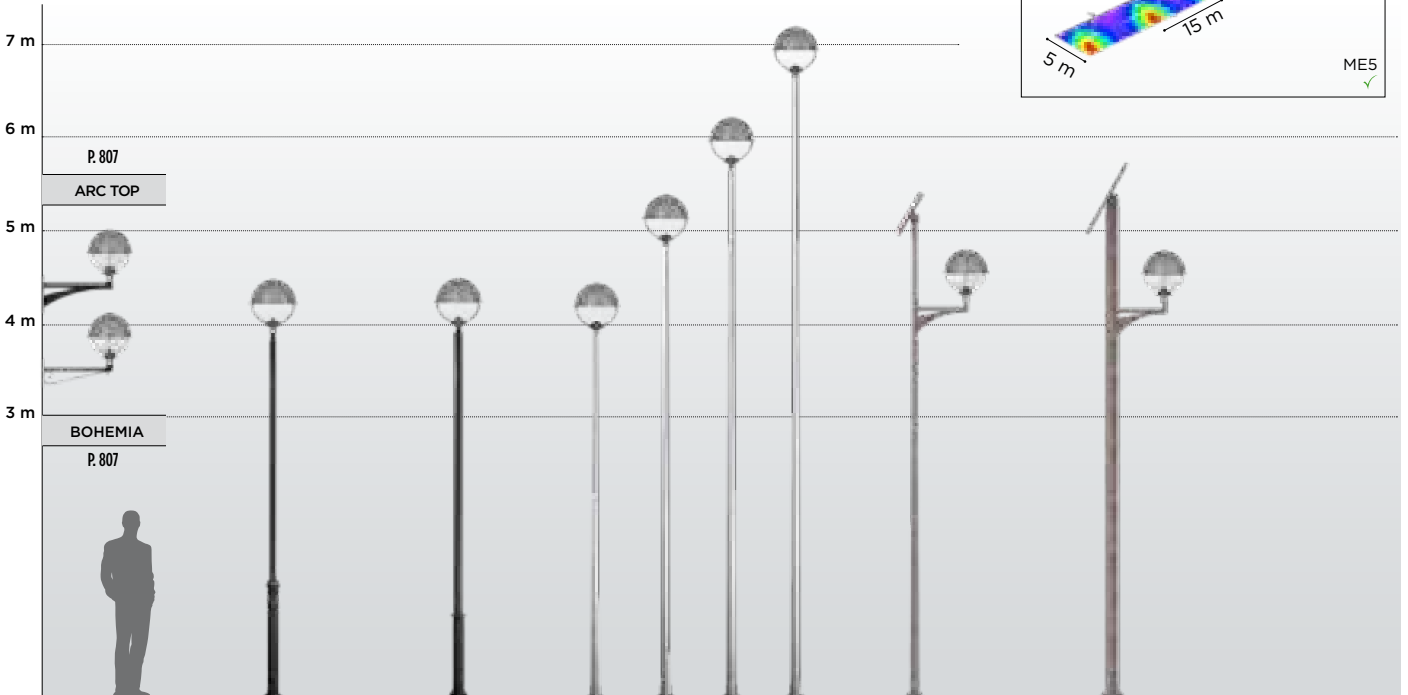
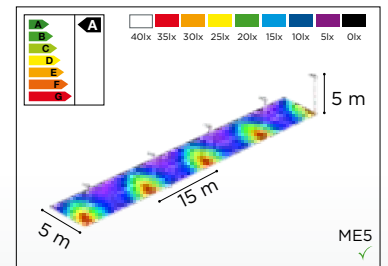
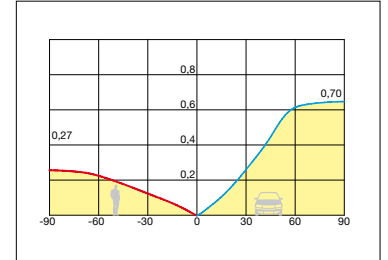

BOHEMIA	NIKOLSON	CONICAL	SOLAR-ECO TOP	SOLAR-TECH TOP
P. 805	P. 804	P. 801	P. 800	P. 800

Model	Height	Code 1	Code 2	Code 3	Code 4	Code 5	Code 6	Code 7
BOHEMIA	4m	81-3123-BP-BP	71-4521-48-48	71-4524-48-48	✓	X	71-3148-48-48	X
NIKOLSON	4m	81-3145-BP-BP	71-4520-48-48	71-4524-48-48	✓	X	71-3128-48-48	X
CONICAL	7m	81-3149-AV-AV	71-4540-48-48	71-4525-48-48	✓	X	71-4531-48-48	X
	6m	81-4535-AV-AV	71-4539-48-48	71-4524-48-48	✓	X	71-4531-48-48	X
	5m	81-4534-AV-AV	71-4539-48-48	71-4524-48-48	✓	X	71-4531-48-48	X
	4m	81-3151-AV-AV	71-4520-48-48	71-4524-48-48	✓	X	71-4531-48-48	X
SOLAR-ECO TOP	5m	81-3256-AV-AV	71-4539-48-48	71-4524-48-48	✓	x	71-4531-48-48	P. 798
SOLAR-TECH TOP	5m	81-3255-AV-AV	71-4521-48-48	71-4525-48-48	✓	x	71-4531-48-48	P. 799
ARC TOP	ARM	82-3012-BP-BP						
BOHEMIA	ARM	82-3124-BP-BP						



OUTDOOR | URBAN

Cambia a fuente de luz led sin sustituir la luminaria y benefíciese de las ventajas de la tecnología led.

Cambia e scegli una fonte di luce led senza sostituire la lampada e beneficia dei vantaggi della tecnologia led.

Change to led light source without replacing the luminaire and benefit from the advantages of led technology.

Troque a fonte de luz led sem substituir a luminária e beneficie das vantagens da tecnologia led.

Passez à une source lumineuse led sans changer de luminaire et profitez des avantages de la technologie led.

Перейдите на светоизлучающие диоды без замены светильников и воспользуйтесь преимуществами светодиодных технологий.

Zum wechsel der led-lichtquelle ohne auswechseln der leuchte, um die vorteile der led-technologie zu nutzen.

Przejdź na źródło światła opartego na diodach bez wymieniaania oprawy oświetleniowej i skorzystaj z zalet technologii led.

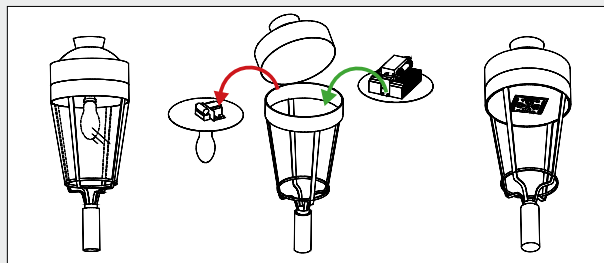
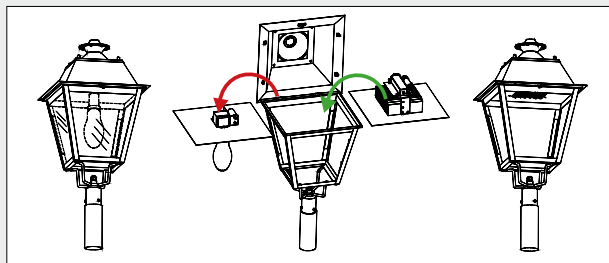

LED KIT

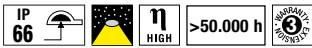

LED OSRAM Neutral white 4000K

30W	16 LED	3.103 lm ^(N)	71-2474-05-M2 ⁽¹⁾	■
45W	20 LED	4.283 lm ^(N)	71-1938-05-M2 ⁽¹⁾	■
65W	28 LED	5.970 lm ^(N)	71-2654-05-M2 ⁽¹⁾	■

NEW

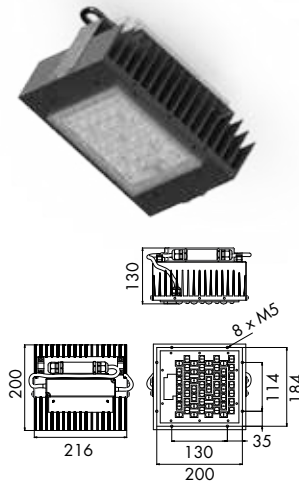

LED 45W
ULOR INST = 1,20%

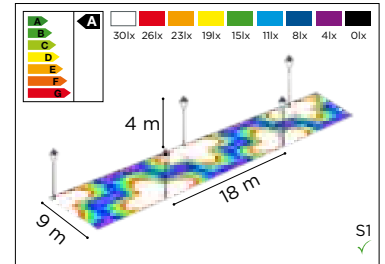
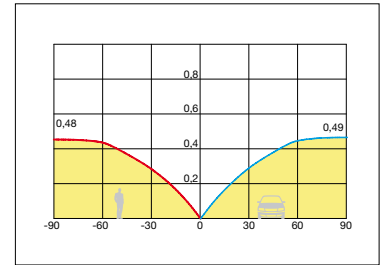
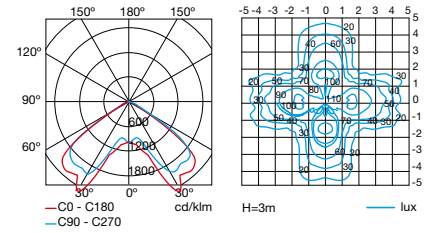

LED KIT



LED OSRAM Neutral white 4000K

30W	16 LED	3.179 lm ^(N)	71-2473-05-M2 ⁽¹⁾	■
45W	20 LED	4.379 lm ^(N)	71-1939-05-M2 ⁽¹⁾	■
65W	28 LED	6.117 lm ^(N)	71-2625-05-M2 ⁽¹⁾	■

NEW

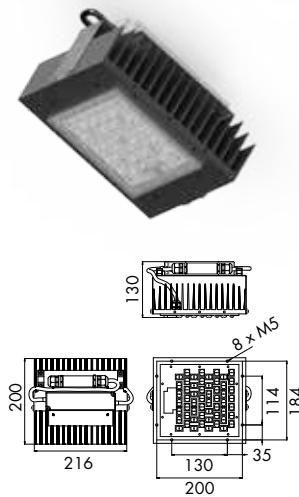

LED 45W
ULOR INST = 0,99%

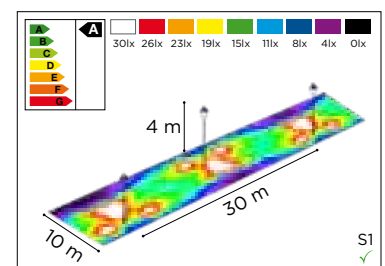
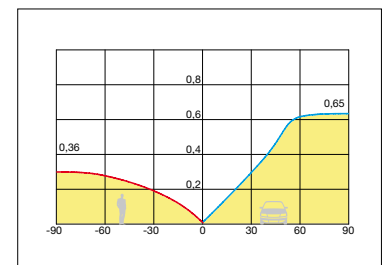
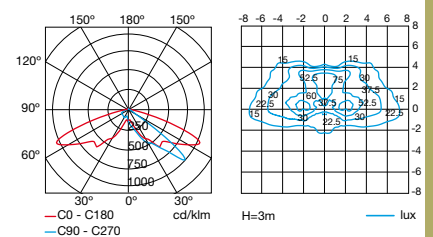

(1)NOTA: EL PRECIO NO INCLUYE LA CHAPA METÁLICA PARA ADAPTAR EL KIT LED A LA LUMINARIA DEL CLIENTE.

(1) NOTE: THE PRICE DOES NOT INCLUDE THE METAL PLATE TO ADAPT THE LED KIT TO THE CLIENT'S LUMINAIRE.

(1) N. B. : LE PRIX NE COMPREND PAS LA PLAQUE MÉTALLIQUE NÉCESSAIRE POUR ADAPTER LE KIT LED AU LUMINAIRE DU CLIENT.

(1) HINWEIS: IM PREIS NICHT ENTHALTEN IST DAS METALLBLECH ZUR ANPASSUNG DES LED-KITS AN DIE LEUCHTE DES KUNDEN.

(1) NOTA: IL PREZZO NON COMPRENDE LA LASTRA METALLICA PER ADATTARE IL KIT LED ALLA LUCE DEL CLIENTE.

(1) NOTA: O PREÇO NÃO INCLUI A CHAPA METÁLICA PARA ADAPTAR O KIT LED À LUMINÁRIA DO CLIENTE.

(1) ПРИМЕЧАНИЕ: В ЦЕНУ НЕ ВКЛЮЧЕНА МЕТАЛЛИЧЕСКАЯ ПЛАСТИНА ДЛЯ АДАПТАЦИИ СВЕТОДИОДНЫХ КОМПЛЕКТОВ К СВЕТИЛЬНИКАМ КЛИЕНТА.

(1) UWAGA: CENA NIE OBEJMUJE METALOWEJ BLACHY DO DOSTOSOWANIA ZESTAWU LED DO OPRAWY OŚWIETLENIOWEJ KLIENTA.

Zonas según radiación solar anual media (kWh/m²)
 Zones by average annual solar radiation (kWh/m²)
 Zones en fonction de la radiation solaire annuelle moyenne (kWh/m²)
 Zone in base alla radiazione solare media annua (kWh/m²)
 Zonas segundo a radiação solar anual média (kWh/m²)
 Bereiche nach durchschnittlicher jährlicher Sonneneinstrahlung (kWh/m²)
 Strefy w zależności od średniego rocznego promieniowania słonecznego (kWh/m²)
 Зоны в соответствии со среднегодовой солнечной радиацией (кВтч/м²)

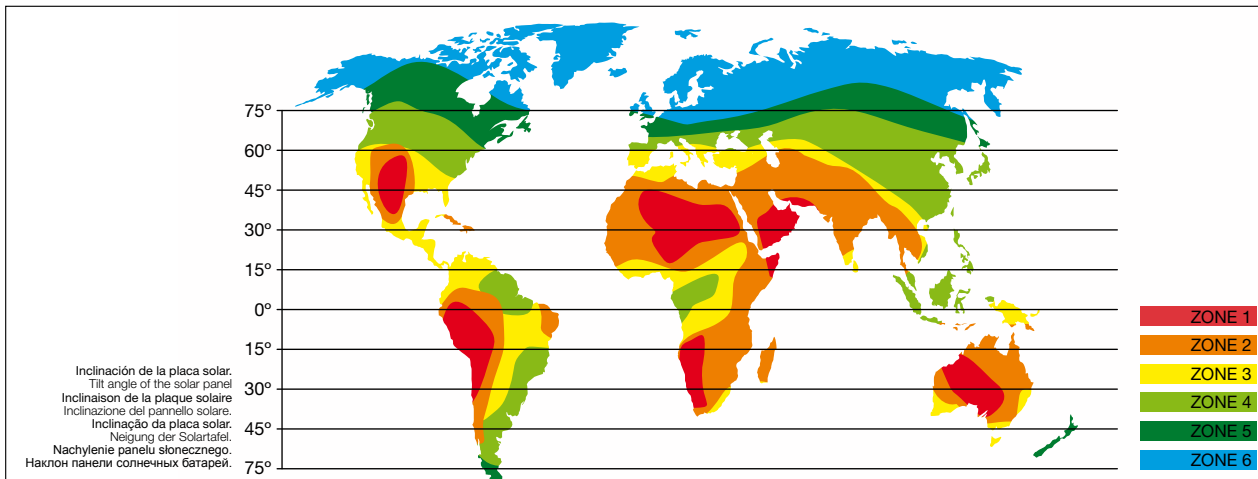

SOLAR-ECO® KIT NEW

CABEZALES COMPATIBLES

COMPATIBLE HEADS

TÊTES COMPATIBLES

KOMPATIBLE KÖPFE

TESTATE COMPATIBILI

CABEÇAS COMPATÍVEIS

СОВМЕСТИМЫЕ ГОЛОВКИ

KOMPATYBILNE GŁOWICE



El código incluye un panel fotovoltaico con soporte regulable y un armario anti-vandálico con batería y controlador.

Autonomía de dos días. Cinco posibilidades de regulación: 2h, 4h, 6h, "3h + apagado + 1h" y "4h + apagado + 2h". Batería con 700 ciclos de carga garantizados.

O código inclui um painel fotovoltaico com suporte regulável e um armário antivandalismo com bateria e controlador.

Autonomia de dois dias. Cinco possibilidades de regulação: 2 h, 4 h, 6 h, "3 h + apagado + 1 h" e "4 h + apagado + 2 h". Bateria com 700 ciclos de carga garantidos.

The code includes a photovoltaic panel with adjustable support and an anti-vandal cabinet with battery and controller.

Two-day autonomy. Five possible settings: 2h, 4h, 6h, "3h + off + 1h" and "4h + off + 2h". Battery with 700 charge cycles guaranteed.

Zum Lieferumfang des Artikels gehört eine Solartafel mit regulierbarer Halterung und ein vandalsicherer Schaltschrank mit Akku und Steuerung.

Zwei Tage Betriebsautonomie. Fünf Einstelloptionen: 2Std., 4Std., 6 Std., "3Std. + Aus + 1Std." und "4Std. + Aus + 2Std.". Akku mit garantierten 700 Ladezyklen.

Le produit comprend un panneau photovoltaïque avec support réglable et une armoire antivandalisme munie d'une batterie et d'un contrôleur.

Deux jours d'autonomie. Cinq possibilités de réglage : 2 h, 4 h, 6 h, « 3 h + éteint + 1 h » et « 4 h + éteint + 2 h ». Batterie garantissant 700 cycles de charge.

КОМПЛЕКТ АРТИКУЛА ВКЛЮЧАЕТ В СЕБЯ ФОТОЭЛЕКТРИЧЕСКИЕ ПАНЕЛИ С РЕГУЛИРУЕМЫМ КРОНШТЕЙНОМ И ШКАФ С ЗАЩИТОЙ ОТ ВАНДАЛОВ С АККУМУЛЯТОРОМ И КОНТРОЛЛЕРОМ.

ДВУХДНЕВНАЯ АВТОНОМНАЯ РАБОТА. ПЯТЬ ВОЗМОЖНЫХ НАСТРОЕК: 2 Ч, 4 Ч, 6 Ч, "3 Ч + ВЫКЛ + 1 Ч" И "4 Ч + ВЫКЛ + 2 Ч". АККУМУЛЯТОР С ГАРАНТИРОВАННЫМ КОЛИЧЕСТВОМ ЦИКЛОВ ЗАРЯДКИ (700 ЦИКЛОВ).

Il codice comprende un pannello fotovoltaico con supporto regolabile e un armadio antivandalismo con batteria e regolatore.

Autonomia di due giorni. Cinq possibilità di regolazione: 2h, 4h, 6h, "3h + spento + 1h" e "4h + spento + 2h". Bateria con 700 cicli di carica garantiti.

TEN KOD OBEJMUJE PANEL FOTOWOLTALICZNY Z REGULOWANYM WSPORNIKIEM ORAZ SZAFĘ ANTYWŁAMANIOWĄ Z BATERIĄ I NASTAWNIKIEM.

AUTONOMIA PRZEZ DWA DNI. PIĘĆ MOŻLIWOŚCI REGULACJI: 2H, 4H, 6H, "3H + WYGASZANIE + 1H" I "4H + WYGASZANIE + 2H". BATERIA O ZAGWARANTOWANYCH 700 CYKLACH ŁADOWANIA.



ESENCIAL



ELIPSE



MERIDIAN



BOHEMIA



ANDALUCIA



NEOBOLA

	30W	45W
	2 ☾	2 ☾
ZONE 1	71-3255-00-00 (100%)*	71-3256-00-00 (100%)*
ZONE 2	71-3255-00-00 (100%)*	71-3256-00-00 (100%)*
ZONE 3	71-3255-00-00 (100%)*	71-3256-00-00 (100%)*
ZONE 4	71-3257-00-00 (100%)*	71-3256-00-00 (100%)*

SOLAR-TECH® KIT NEW

CABEZALES COMPATIBLES

COMPATIBLE HEADS

TÊTES COMPATIBLES

KOMPATIBLE KÖPFE

TESTATE COMPATIBILI

CABEÇAS COMPATÍVEIS

СОВМЕСТИМЫЕ ГОЛОВКИ

KOMPATYBILNE GŁOWICE



ESENCIAL



ELIPSE



MERIDIAN



BOHEMIA



ANDALUCIA



NEOBOLA



El código incluye un panel fotovoltaico con soporte regulable y un armario anti-vandálico con batería y controlador.

Regulación por mppt. Compatible con sensor de presencia, comunicación rf y alimentación por red eléctrica. Reloj astronómico interno. Función "nunca apagado". Fusibles integrados y led de control de estado. Batería con 1.500 Ciclos de carga garantizados.

O código inclui um painel fotovoltaico com suporte regulável e um armário antivandalismo com bateria e controlador.

Regulação por mppt. Compatível com sensor de presença, comunicação rf e alimentação por rede elétrica. Relógio astronómico interno. Função "nunca apagado". Fusíveis integrados e led de controlo de estado. Bateria com 1500 ciclos de carga garantidos.

The code includes a photovoltaic panel with adjustable support and an anti-vandal cabinet with battery and controller.

Mppt regulation. Compatible with presence detector, rf communication and power via mains supply. Internal astronomical clock. "Never off" function. Integrated fuses and status control leds. Battery with 1500 charge cycles guaranteed.

Zum Lieferumfang des Artikels gehört eine Solartafel mit regulierbarer Halterung und ein vandalmussicherer Schaltschrank mit Akku und Steuerung.

Regulierung per mppt. Kompatibel mit anwesenheitssensor, funktionsübertragung und anschluss ans stromnetz. Mit integrierter astronomischer uhr. Immeran-funktion. Mit integrierten sicherungen und led zur statuskontrolle. Akku mit garantierten 1500 laadezyklen.

Le produit comprend un panneau photovoltaïque avec support réglable et une armoire antivandalisme munie d'une batterie et d'un contrôleur.

Réglage par mppt. Compatible avec détecteur de présence, communication rf et alimentation par réseau électrique. Horloge astronomique interne. Fonction « jamais éteint ». Fusibles intégrés et led de contrôle d'état. Batterie garantissant 1 500 cycles de charge.

КОМПЛЕКТ АРТИКУЛА ВКЛЮЧАЕТ В СЕБЯ ФОТОЭЛЕКТРИЧЕСКИЕ ПАНЕЛИ С РЕГУЛИРУЕМЫМ КРОНШТЕЙНОМ И ШКАФ С ЗАЩИТОЙ ОТ ВАНДАЛОВ С АККУМУЛЯТОРОМ И КОНТРОЛЛЕРОМ.

РЕГУЛИРОВКА С ПОМОЩЬЮ МРРТ. СОВМЕСТИМОСТЬ С ДАТЧИКОМ ПРИСУТСТВИЯ, РАДИОСВЯЗЬЮ И ЭЛЕКТРИЧЕСКОЙ СЕТЬЮ ПИТАНИЯ. ВНУТРЕННИЕ АСТРОНОМИЧЕСКИЕ ЧАСЫ. ФУНКЦИЯ " НИКОГДА НЕ ВЫКЛЮЧЕН". ВСТРОЕННЫЕ ПРЕДОХРАНИТЕЛИ И СВЕТОДИОД КОНТРОЛЯ СОСТОЯНИЯ. АККУМУЛЯТОР С ГАРАНТИРОВАННЫМ КОЛИЧЕСТВОМ ЦИКЛОВ ЗАРЯДКИ 1.500.

Il codice comprende un pannello fotovoltaico con supporto regolabile e un armadio antivandalo con batteria e regolatore.

Regolazione per mppt. Compatibile con sensore di presenza, comunicazione rf e alimentazione tramite rete elettrica. Orologio astronomico interno. Funzione "mai spento". Fusibili integrati e led di controllo di stato. Batteria con 1500 cicli di carica garantiti.

TEN KOD OBEJMUJE PANEL FOTOWOLTAICZNY Z REGULOWANYM WSPORNIKIEM ORAZ SZAFĘ ANTYWŁAMANIOWĄ Z BATERIĄ I NASTAWNIKIEM.

REGULACJA ZA POMOCĄ MPPT. KOMPATYBILNA Z CZUJNIKIEM OBECNOŚCI, ŁĄCZNOŚĆ CZĘSTOTLIWOŚCIĄ RADIOWĄ I ZASILANIE Z SIECI ELEKTRYCZNEJ. WEWNĘTRZNY ZEGAR ASTRONOMICZNY. FUNKCJA "NIGDY NIETYŁACZONY". WBUDOWANE BEZPIECZNIKI I LED KONTROLI STANU. BATERIA O ZAGWARANTOWANYCH 1500 CYKLACH ŁADOWANIA.

	30W		45W		65W
	3☾	6☾	2☾	4☾	3☾
ZONE 1	71-2468-00-00 (100%)*	71-2467-00-00 (100%)*	71-2468-00-00 (85%)*	71-2467-00-00 (85%)*	71-4768-00-00 (95%)*
ZONE 2	71-2468-00-00 (95%)*	71-2467-00-00 (95%)*	71-4769-00-00 (100%)*	71-4768-00-00 (100%)*	71-4768-00-00 (85%)*
ZONE 3	71-2468-00-00 (90%)*	71-2467-00-00 (90%)*	71-4769-00-00 (95%)*	71-4768-00-00 (95%)*	71-2509-00-00 (100%)*
ZONE 4	71-4769-00-00 (100%)*	71-4768-00-00 (100%)*	71-4769-00-00 (90%)*	71-4768-00-00 (90%)*	71-2509-00-00 (85%)*
ZONE 5	71-4769-00-00 (90%)*	71-4768-00-00 (90%)*	71-2508-00-00 (90%)*	71-2509-00-00 (90%)*	

*PROMEDIO DE FLUJO LUMÍNICO ANUAL GARANTIZADO.

*AVERAGE ANNUAL LUMINOUS FLUX GUARANTEED.

*MOYENNE DE FLUX LUMINEUX ANNUEL GARANTI.

*GARANTIERER JÄHRLICHER DURCHSCHNITTLICHTFLUSS.

*MEDIA DI FLUSSO LUMINOSO ANNUO GARANTITA.

*MÉDIA DE FLUXO LUMINOSO ANUAL GARANTIDA.

*ГАРАНТИРОВАННЫЙ СРЕДНИЙ ГОДОВОЙ СВЕТОВОЙ ПОТОК.

*ZAGWARANTOWANA ŚREDNIA ROCZNA STRUMIENIA ŚWIETLNEGO.



OUTDOOR | URBAN

SOLAR NEW



CABEZALES COMPATIBLES

COMPATIBLE HEADS

TÊTES COMPATIBLES

KOMPATIBLE KÖPFE

TESTATE COMPATIBILI

CABEÇAS COMPATÍVEIS

СОВМЕСТИМЫЕ ГОЛОВКИ

KOMPATYBILNE GŁOWICE

Ø60 mm LATERAL



ESENCIAL



ELIPSE

Ø60 mm TOP



MERIDIAN



NEOBOLA



ANDALUCIA ⁽¹⁾



BOHEMIA

(1)



71-4470-BP-BP ■

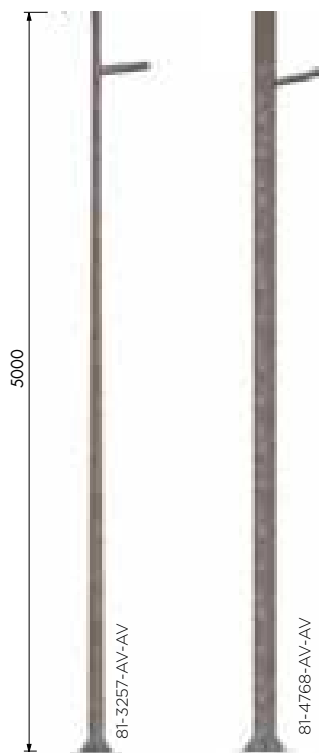

SOLAR-ECO LATERAL

SOLAR-TECH LATERAL

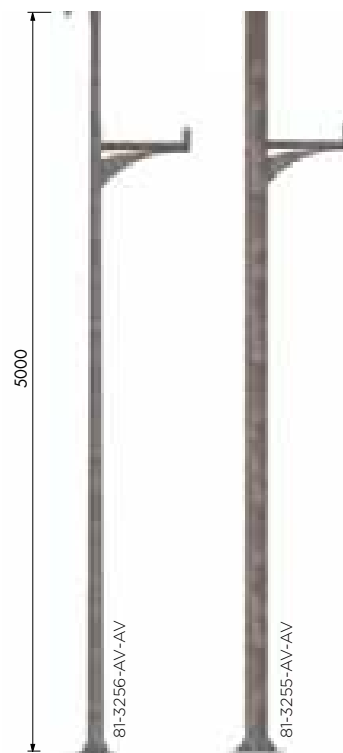

SOLAR-ECO TOP

SOLAR-TECH TOP



SOLAR-ECO LATERAL	5m	81-3257-AV-AV ■	71-4539-48-48	71-4524-48-48	✓	X	71-4531-48-48	P. 798
SOLAR-TECH LATERAL	5m	81-4768-AV-AV ■	71-4521-48-48	71-4525-48-48	✓	X	71-4531-48-48	P. 799
SOLAR-ECO TOP	5m	81-3256-AV-AV ■	71-4539-48-48	71-4524-48-48	✓	X	71-4531-48-48	P. 798
SOLAR-TECH TOP	5m	81-3255-AV-AV ■	71-4521-48-48	71-4525-48-48	✓	X	71-4531-48-48	P. 799

CONICAL



CABEZALES COMPATIBLES

COMPATIBLE HEADS

TÊTES COMPATIBLES

KOMPATIBLE KÖPFE

TESTATE COMPATIBILI

CABEÇAS COMPATÍVEIS

СОВМЕСТИМЫЕ ГОЛОВКИ

KOMPATYBILNE GŁOWICE



MERIDIAN



ESENCIAL ⁽¹⁾



ESENCIAL HP



ROADWAY



MINI ROADWAY



ECOVIAL ⁽¹⁾



GAVINA



ELIPSE



NEOBOLA



ANDALUCIA ⁽²⁾



BOHEMIA

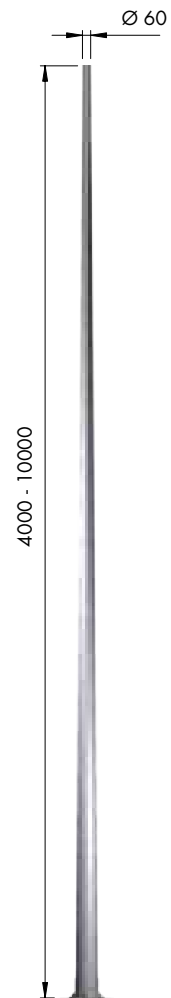

CONICAL	10m	81-4538-AV-AV	71-4541-48-48	71-4525-48-48	71-4531-48-48
	9m	81-4537-AV-AV	71-4540-48-48	71-4525-48-48	71-4531-48-48
	8m	81-4536-AV-AV	71-4540-48-48	71-4525-48-48	71-4531-48-48
	7m	81-3149-AV-AV	71-4540-48-48	71-4525-48-48	71-4531-48-48
	6m	81-4535-AV-AV	71-4539-48-48	71-4524-48-48	71-4531-48-48
	5m	81-4534-AV-AV	71-4539-48-48	71-4524-48-48	71-4531-48-48
	4m	81-3151-AV-AV	71-4520-48-48	71-4524-48-48	71-4531-48-48

(1)



71-4554-AV-AV 71-4555-AV-AV

(2)



71-4470-BP-BP ■



OUTDOOR | URBAN

CYLINDRICAL



CABEZALES COMPATIBLES

COMPATIBLE HEADS

TÊTES COMPATIBLES

KOMPATIBLE KÖPFE

TESTATE COMPATIBILI

CABEÇAS COMPATÍVEIS

СОВМЕСТИМЫЕ ГОЛОВКИ

KOMPATYBILNE GŁOWICE



ESENCIAL



ESENCIAL HP



ROADWAY



MINI ROADWAY

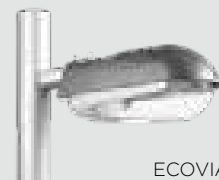

ECOIVAL



ELIPSE

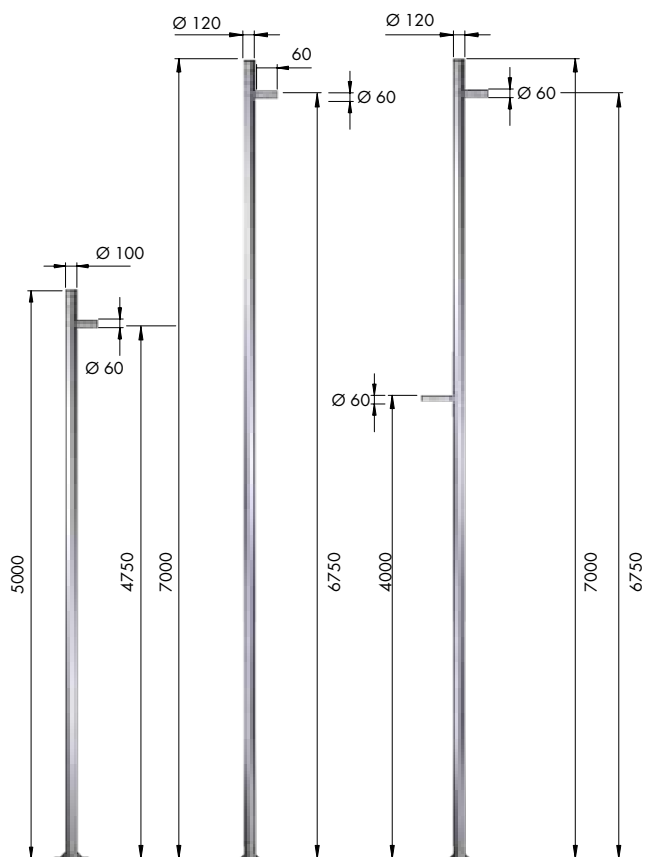

CYLINDRICAL	4+7m	81-3133-AU-AU ■	71-4522-48-48	71-4525-48-48	71-3128-48-48
	7m	81-3132-AU-AU ■	71-4522-48-48	71-4525-48-48	71-3128-48-48
	5m	81-3128-AU-AU ■	71-4539-48-48	71-4524-48-48	71-3128-48-48

SQUADRA



CABEZALES COMPATIBLES

COMPATIBLE HEADS

TÊTES COMPATIBLES

KOMPATIBLE KÖPFE

TESTATE COMPATIBILI

CABEÇAS COMPATÍVEIS

СОВМЕСТИМЫЕ ГОЛОВКИ

KOMPATYBILNE GŁOWICE



ESENCIAL



ESENCIAL HP



ROADWAY



MINI ROADWAY



ECOIVAL



ELIPSE

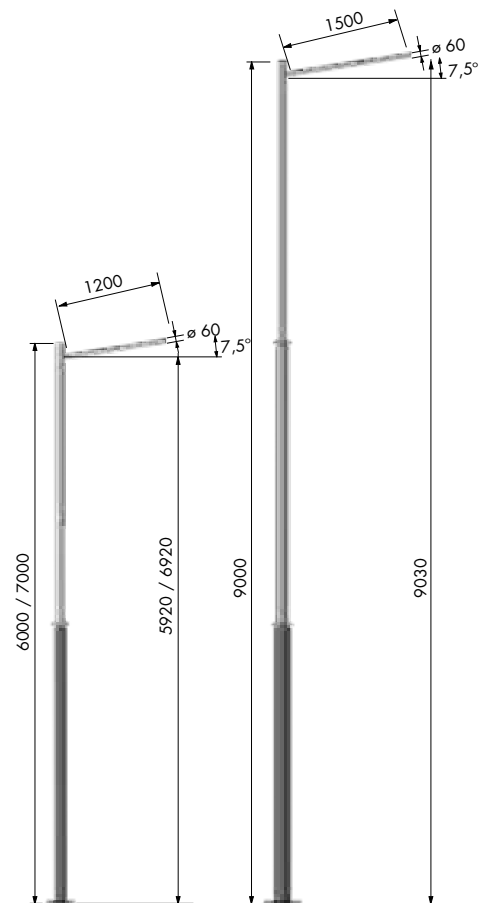

SQUADRA	9m	81-4533-BP-AV ■■■	71-4540-48-48	71-4525-48-48	71-4531-48-48
	7m	81-4532-BP-AV ■■■	71-4540-48-48	71-4525-48-48	71-4531-48-48
	6m	81-4531-BP-AV ■■■	71-4539-48-48	71-4524-48-48	71-4531-48-48



OUTDOOR | URBAN

NIKOLSON



CABEZALES COMPATIBLES

COMPATIBLE HEADS

TÊTES COMPATIBLES

KOMPATIBLE KÖPFE

TESTATE COMPATIBILI

CABEÇAS COMPATÍVEIS

СОВМЕСТИМЫЕ ГОЛОВКИ

KOMPATYBILNE GŁOWICE



MERIDIAN



ELIPSE



NEOBOLA



ANDALUCIA ⁽¹⁾



BOHEMIA

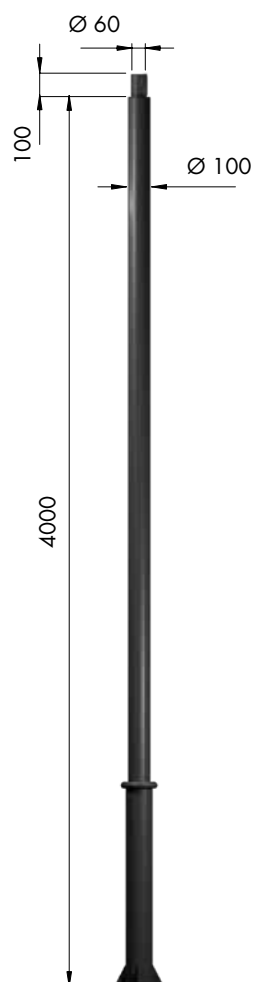

NIKOLSON 4m 81-3145-BP-BP ■ 71-4520-48-48 71-4524-48-48 71-3128-48-48

(1)



71-4470-BP-BP ■

BOHEMIA



CABEZALES COMPATIBLES

COMPATIBLE HEADS

TÊTES COMPATIBLES

KOMPATIBLE KÖPFE

TESTATE COMPATIBILI

CABEÇAS COMPATÍVEIS

СОВМЕСТИМЫЕ ГОЛОВКИ

KOMPATYBILNE GŁOWICE



MERIDIAN



ELIPSE



NEOBOLA



ANDALUCIA (1)



BOHEMIA

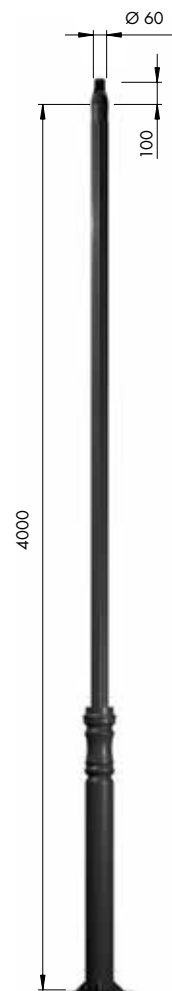

BOHEMIA 4m 81-3123-BP-BP ■ 71-4521-48-48 71-4524-48-48 71-3148-48-48

(1)



71-4470-BP-BP ■



OUTDOOR | URBAN

PROMENADE



CABEZALES COMPATIBLES

COMPATIBLE HEADS

TÊTES COMPATIBLES

KOMPATIBLE KÖPFE

TESTATE COMPATIBILI

CABEÇAS COMPATÍVEIS

СОВМЕСТИМЫЕ ГОЛОВКИ

KOMPATYBILNE GŁOWICE



PROMENADE

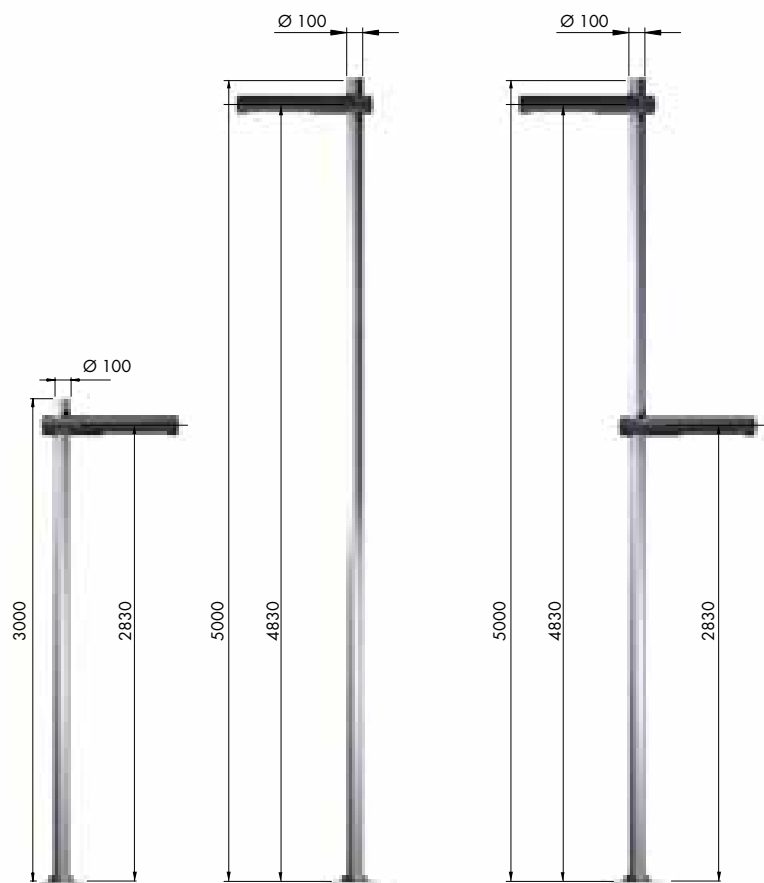

	5 + 3 m	81-3140-AU-AU ■	71-4539-48-48	71-4524-48-48	71-4531-48-48
PROMENADE	5m	81-3140-AU-AU ■	71-4539-48-48	71-4524-48-48	71-4531-48-48
	3m	81-3137-AU-AU ■	71-4520-48-48	71-4524-48-48	71-4531-48-48

BOHEMIA



BOHEMIA 82-3124-BP-BP ■

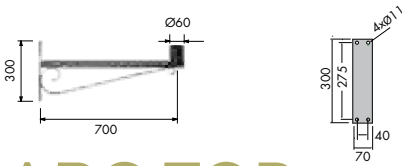

ARC TOP



ARC TOP 82-3012-BP-BP ■

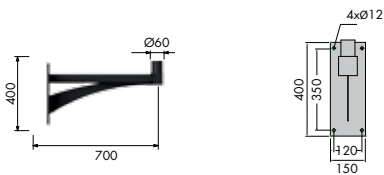

ARC LATERAL



ARC LATERAL 82-3030-BQ-BQ ■



ELIPSE



ELIPSE 82-3029-BQ-BQ ■

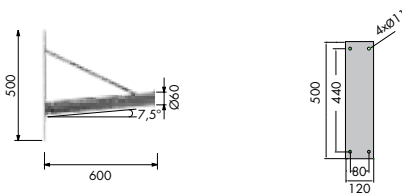

BRACKETS



GAVINA DOUBLE BRACKET 71-3044-AV-AV ■■

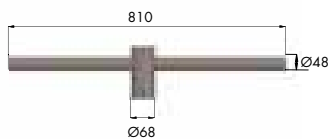

SINGLE BRACKET 71-4554-AV-AV ■■

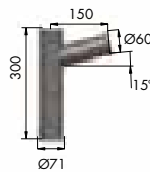

DOUBLE BRACKET 71-4555-AV-AV ■■

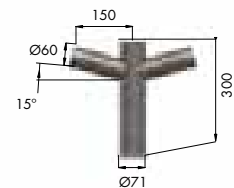

CABEZALES COMPATIBLES
COMPATIBLE HEADS
TÊTES COMPATIBLES
KOMPATIBLE KÖPFE
TESTATE COMPATIBILI
CABEÇAS COMPATÍVEIS
СОВМЕСТИМЫЕ ГОЛОВКИ
KOMPATYBILNE GŁOWICE



GAVINA

CABEZALES COMPATIBLES
COMPATIBLE HEADS
TÊTES COMPATIBLES
KOMPATIBLE KÖPFE
TESTATE COMPATIBILI
CABEÇAS COMPATÍVEIS
СОВМЕСТИМЫЕ ГОЛОВКИ
KOMPATYBILNE GŁOWICE



ESENCIAL



ECOVIAL

CABEZALES COMPATIBLES
COMPATIBLE HEADS
TÊTES COMPATIBLES
KOMPATIBLE KÖPFE
TESTATE COMPATIBILI
CABEÇAS COMPATÍVEIS
СОВМЕСТИМЫЕ ГОЛОВКИ
KOMPATYBILNE GŁOWICE

(1)



71-4470-BP-BP ■



MERIDIAN



NEOBOLA



ANDALUCIA (3)



BOHEMIA

CABEZALES COMPATIBLES
COMPATIBLE HEADS
TÊTES COMPATIBLES
KOMPATIBLE KÖPFE
TESTATE COMPATIBILI
CABEÇAS COMPATÍVEIS
СОВМЕСТИМЫЕ ГОЛОВКИ
KOMPATYBILNE GŁOWICE

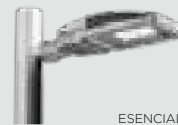

ESENCIAL



ESENCIAL HP



ROADWAY



MINI ROADWAY



ECOVIAL



ELIPSE



OUTDOOR | URBAN



EMOTIONAL



838-839

DOTS

PUNTOS
POINTS LUMINEUX
PUNKTE
PUNTI
PONTOS
ТОЧКИ
PUNKTY



840-841

FLEXIBLE CURTAINS

CORTINAS FLEXIBLES
RIDEAUX FLEXIBLES
FLEXIBLE VORHÄNGE
TENDE FLESSIBILI
CORTINAS FLEXÍVEIS
ГИБКИЕ ЗАНАВЕСЫ
ELASTYCZNE ZASŁONY



842

OUTDOOR DISPLAY

PANTALLA EXTERIOR
ÉCRAN D'EXTÉRIEUR
AUSSEN DISPLAY
SCHERMO ESTERNO
ECRÁ EXTERIOR
ЭКРАНЫ ДЛЯ УЛИЧНОГО ПРИМЕНЕНИЯ
EKAN ZEWNETRZNY



843

OUTDOOR TUBES

TUBOS EXTERIOR
TUBES D'EXTÉRIEUR
AUSSEN RÖHREN
TUBI ESTERNI
TUBOS DE EXTERIOR
СВЕТОДИОДНЫЕ ТРУБКИ ДЛЯ УЛИЧНОГО ПРИМЕНЕНИЯ
TUBY ZEWNETRZNE



844-845

INDOOR DISPLAY

PANTALLA INTERIOR
ÉCRAN D'INTÉRIEUR
INNEN DISPLAY
SCHERMO INTERNO
ECRÁ DE INTERIOR
ЭКРАНЫ ДЛЯ ИНТЕРЬЕРА ПОМЕЩЕНИЙ
EKAN WEWNĘTRZNY



846-847

LED FLOOR

SUELO LED
SOL LED
LED BODENEINBAU
PAVIMENTO LED
LED DE CHÃO
СВЕТОДИОДНЫЙ ПОЛ
PODŁOGA LED



HOSPITALITY



LT-20
P843



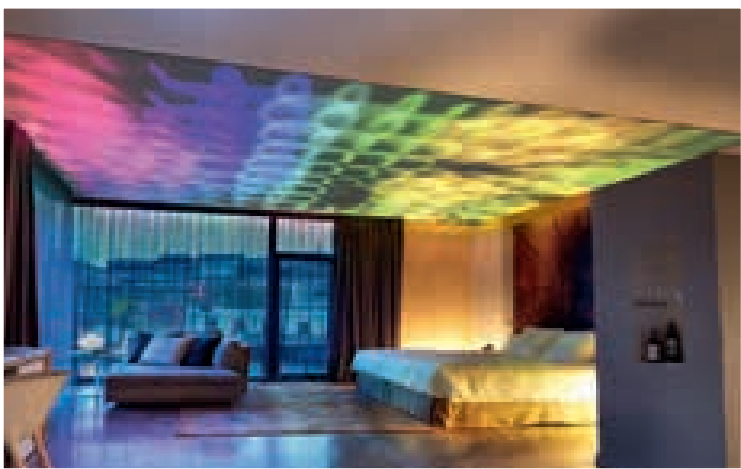

HOSPITALITY



▶ Video





HOSPITALITY



NO-1
P.838



HOSPITALITY



NO-2
P.838

+



DF-20
P.846

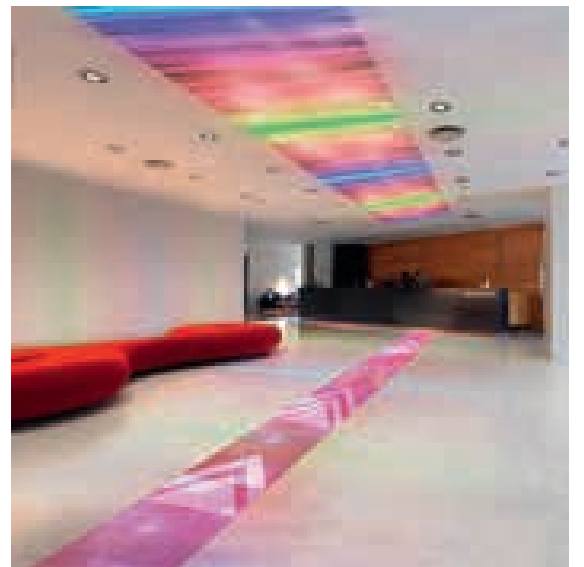

HOSPITALITY



NO-1
P.838

+



DF-20
P.846



▶ Video



HOSPITALITY



NO-3
P.838



▶ Video

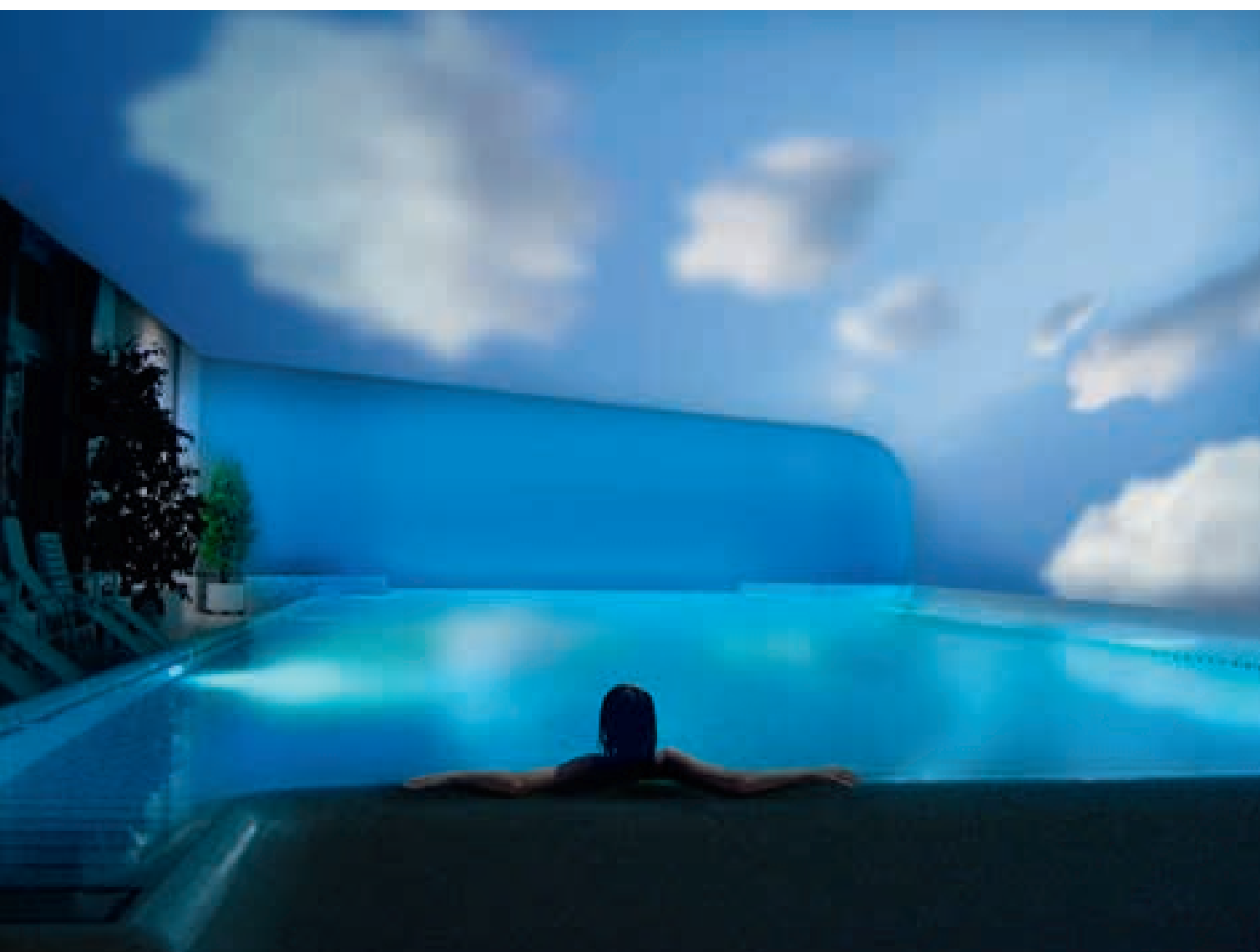



HOSPITALITY



NO-1
P.838

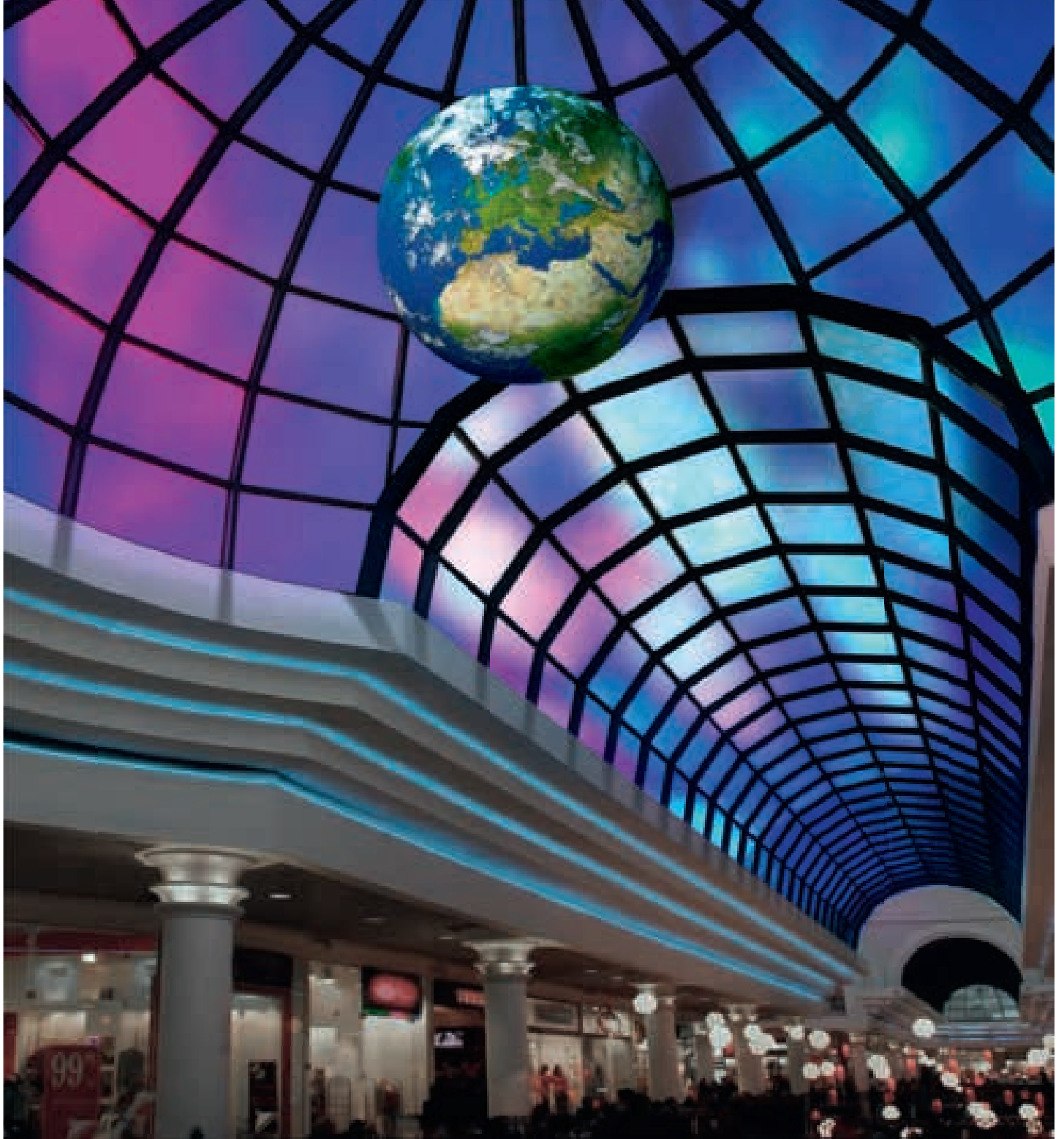

RETAIL



NO-3
P.838



▶ Video

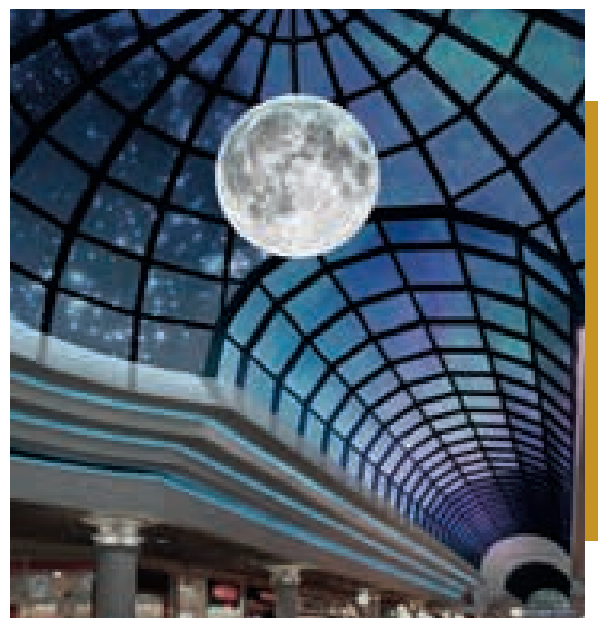



RESTAURANT



NO-2
P.838





RESTAURANT



OC-12
P.840



▶ Video





CLUBBING



NO-1
P.838

+

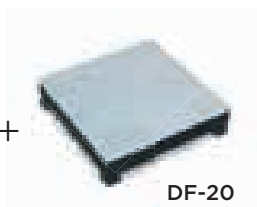

DF-20
P.846



▶ Video

CLUBBING



OC-12
P.840





MUSEUM



OC-12
P.840



CARACTERÍSTICAS DE UNA PANTALLA LED
TYPICAL CHARACTERISTICS OF AN LED SCREEN
CARACTÉRISTIQUES D'UN ÉCRAN LED
MERKMALE EINES LED-DISPLAYS
CARATTERISTICHE DI UNO SCHERMO LED
CARACTERÍSTICAS DE UM ECRÃ LED
ХАРАКТЕРИСТИКИ СВЕТОДИОДНОГО ЭКРАНА
WŁAŚCIWOŚCI EKРАНU LED

01 ¿QUÉ ES UN PÍXEL?

WHAT IS A PIXEL?
QU'EST-CE QU'UN PIXEL?
WAS BEDEUTET PIXEL?
COS'È UN PIXEL?
O QUE É UM PÍXEL?
ЧТО ТАКОЕ ПИКСЕЛЬ?
CO TO JEST PIKSEL?

Es la unidad mínima de representación de una imagen. El conjunto de píxeles genera las imágenes.

It's the smallest element that can be found in an image. When they are put together, pixels create images.

C'est l'unité minimale de représentation d'une image. Un ensemble de pixels crée une image.

Ein Pixel ist die kleinste Einheit bei der Darstellung eines Bildes. Eine Rastergrafik setzt sich aus Pixeln zusammen.

È l'unità minima di rappresentazione di un'immagine. È l'insieme dei pixel che crea le immagini.

É a unidade mínima de representação de uma imagem. O conjunto de píxeis gera as imagens.

Пиксель – это минимальная единица воспроизведения изображения. Изображение – это комбинация пикселей.

Piksel to najmniejszy element wyświetlanego obrazu. Grupa pikseli tworzy obrazy.

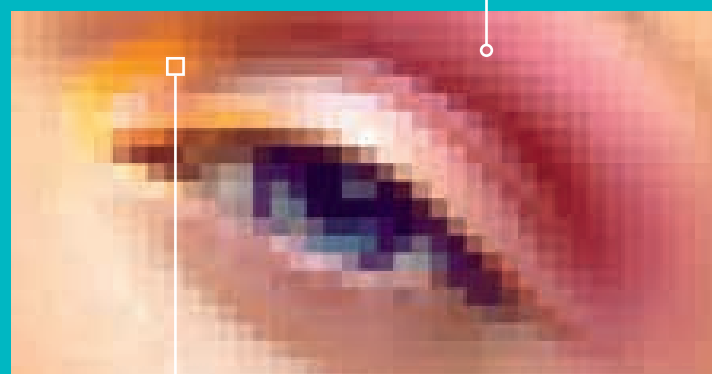
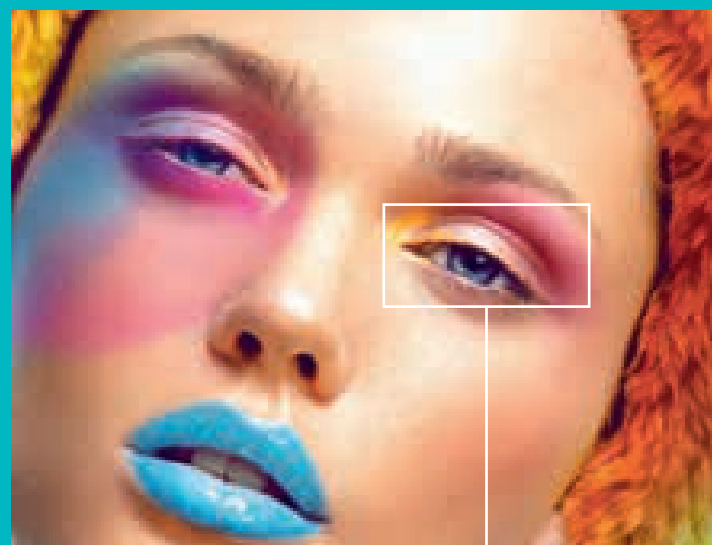

1 PIXEL

EXISTEN 2 TIPOS:
DIP Y SMD

THERE ARE 2 TYPES:
DIP AND SMD

IL EXISTE DEUX TYPES DE PIXELS:
DIP ET SMD

STEHEN ZWEI VERSCHIEDENE
LED-FORMATE ZUR AUSWAHL:
DIP UND SMD

ESISTONO DUE TIPI:
DIP E SMD

EXISTEM 2 TIPOS:
DIP E SMD

СУЩЕСТВУЮТ 2 ФОРМАТА:
СТАНДАРТНЫЙ (DIP) И
ПОВЕРХНОСТНОГО МОНТАЖА
(SMD)

WYSTĘPUJĄ 2 TYPY:
DIP I SMD

02

¿CÓMO ES UN PÍXEL FÍSICAMENTE EN UNA PANTALLA LED?

WHAT IS A PIXEL LIKE ON A SCREEN?
QUELLE EST L'APPARENCE D'UN PIXEL DANS UN ÉCRAN?
WIE WIRD EIN PIXEL AUF EINEM DISPLAY DARGESTELLT?
COM'È MATERIALMENTE UN PIXEL IN UNO SCHERMO?
COMO É UM PÍXEL FÍSICAMENTE NUM ECRÃ?
КАК СОЗДАЕТСЯ ПИКСЕЛЬ НА ЭКРАНЕ?
JAK FIZYCZNIE WYGLĄDA JEDEN PIKSEL NA WYŚWIETLACZU?

DIP

Son leds de un solo color. Por su robustez y alto brillo son ideales para aplicaciones de exteriores. Pueden utilizarse en aplicaciones para día y noche. Baja definición.

These are leds of only one single colour. Thanks to their robustness and intense brightness, DIP LEDs are ideal for outdoor applications. They can be used in both day and night applications. It has low definition.

Ce sont des pixels d'une seule couleur. Du fait de leur robustesse et de leur effet brillant intense, les LED DIP sont idéales pour des applications en extérieur. On peut les utiliser dans des applications de jour comme de nuit. Basse définition.

Beim DIP-Format sind die LEDs einfarbig. Die DIP-LED eignen sich aufgrund ihrer Robustheit und ihrer Glanzeigenschaft bestens für Installationen im Freien. Sie können sowohl für Tages- als auch Nachtinstallationen verwendet werden. Niedrige Definition.

I led sono di un solo colore. Grazie alla loro robustezza e alta luminosità, i led DIP sono ideali per applicazioni in esterni. È possibile utilizzarli per applicazioni diurne e notturne. Bassa definizione.

Os leds são de uma única cor. Pela sua robustez e alto brilho são perfeitos para aplicações em exterior. Podem ser utilizados em aplicações diurnas e nocturnas. Baixa definição.

Одноцветные светодиоды. Благодаря своей прочности и особой яркости, они идеально подходят для уличного применения. Они могут использоваться и днем, и ночью. Они обладают низким разрешением.

To diody jednobarwne. Dzięki ich solidnej budowie i wysokiej jasności, diody DIP są idealne do zastosowań zewnętrznych. Mogą być stosowane do oświetlenia dziennego i nocnego. Niska rozdzielczość.

1 PIXEL =



1 RED + 1 GREEN + 1 BLUE

OR



2 RED + 1 GREEN + 1 BLUE

SMD

Los leds SMD por su integración RGB son ideales para aplicaciones de alta definición, donde requerimos un paso (pitch) muy bajo.

The SMD LED has an RGB system integrated in a single point. SMD LEDs are ideal for indoor high definition applications.

La LED SMD intègre le système RGB en un seul point. Du fait de leur intégration RGB, les LED SMD sont idéales pour des applications à haute définition.

Die SMD-Bauweise des LED hat ein integriertes RGB an einem Punkt, so dass ein SMD-LED einem Pixel entspricht. Die SMD-LEDs sind ideal für Einsatzbereiche mit hoher Definition.

Poiché nel led SMD il sistema RGB è integrato in un sol punto, grazie a questa integrazione, i led SMD sono ideali per applicazioni d'alta definizione.

Tem integrado o sistema RGB num único ponto. São perfeitos para aplicações em interior e alta definição.

Светодиоды поверхностного монтажа (SMD) обладают встроенной системой RGB в каждой световой точке. Светодиоды SMD идеальны для применений с высоким разрешением, где требуется очень низкий шаг (pitch).

Diody SMD mają zintegrowany system RGB w jednym punkcie. Są one idealne do zastosowań wewnętrznych o wysokich rozdzielczościach.

1 PIXEL = 1 SMD



03

RESOLUCIÓN DE UNA IMAGEN EN UNA PANTALLA LED

RESOLUTION OF AN IMAGE ON A LED SCREEN
RÉSOLUTION D'UNE IMAGE DANS UN ÉCRAN
WAS BEDEUTET AUFLÖSUNG EINER DARSTELLUNG AUF EINEM DISPLAY
RISOLUZIONE DI UN'IMMAGINE SU UNO SCHERMO
RESOLUÇÃO DE UMA IMAGEM NUM ECRÃ
ЧТО ТАКОЕ РАЗРЕШЕНИЕ ИЗОБРАЖЕНИЯ НА ДИСПЛЕЕ
ROZDZIELCZOŚĆ OBRAZU NA WYŚWIETLACZU

La resolución en una pantalla indica cuánto detalle puede observarse en esta. Tener mayor resolución se traduce en obtener una imagen con más detalle o calidad.

The screen resolution indicates how much detail can be seen on the screen. A greater resolution means a more detailed or higher quality image.

La résolution sur l'écran indique le niveau de détail que l'on peut y observer. Disposer d'une résolution supérieure est synonyme d'une image plus détaillée ou d'une meilleure qualité.

Die Auflösung gibt die Detailgenauigkeit an, mit der ein Bild auf einem Display dargestellt wird. Eine höhere Auflösung bedeutet eine detailgetreue Darstellung oder eine bessere Bildqualität.

La risoluzione su uno schermo indica quanti dettagli vi si possono vedere. Una maggiore risoluzione si traduce in un'immagine con più dettagli o qualità.

A resolução num ecrã indica o nível de detalhe que se pode observar nele. Uma maior resolução traduz-se na obtenção de uma imagem com mais detalhe ou qualidade.

Разрешение показывает, насколько хорошо различимы детали изображения. Чем выше разрешение, тем лучше видны детали и тем выше качество изображения.

Rozdzielczość na ekranie wskazuje na ilość szczegółów jakie na nim można zaobserwować. Posiadanie większej rozdzielczości przekłada się na uzyskanie obrazu o większej ilości szczegółów lub jakości.

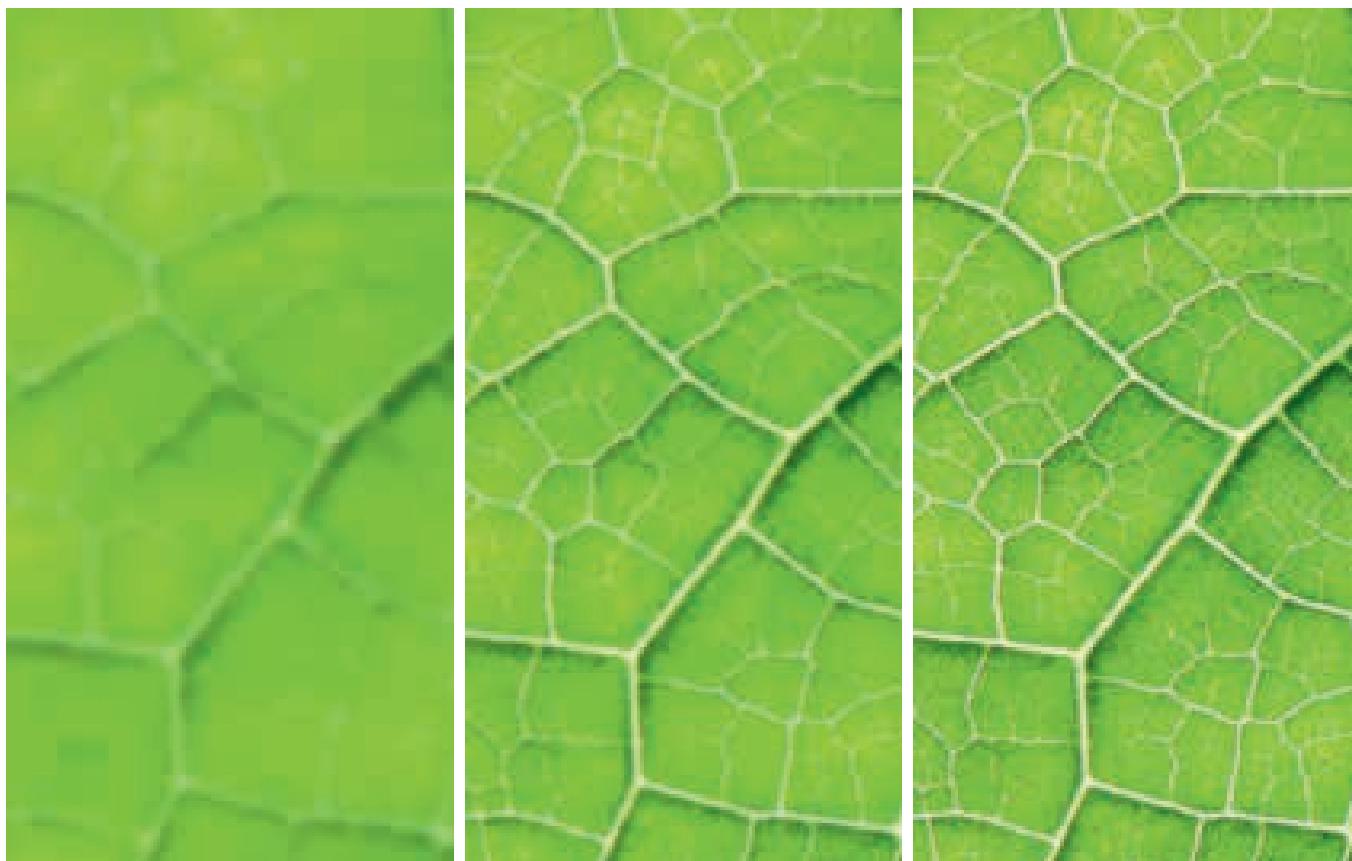

04

PITCH?

PITCH?

WAS BEDEUTET PITCH?

O QUE É O PITCH?

ЧТО ТАКОЕ ШАГ (PITCH)?

ROZSTAW (PITCH)?

Pitch o paso es la distancia entre píxeles (P), determina la distancia recomendada de visión de la imagen.

The pitch is the distance between pixels (P) and determines the recommended distance from which the image is to be seen.

Le «pitch» ou le «pas» est la distance entre les pixels (P) qui détermine la distance recommandée pour la vision de l'image.

Unter Pitch (P) versteht man den Abstand zwischen Pixeln, mit der die empfohlene Blickdistanz bestimmt wird.

Il pitch è la distanza tra i pixel (P) e determina la distanza consigliata per la visione dell'immagine.

Pitch ou passo é a distância entre píxeis (P) determina a distância recomendada de visão da imagem.

Шагом (pitch) называют расстояние между пикселями (P). От шага зависит расстояние, рекомендованное для оптимального восприятия изображения.

Pitch lub rozstaw to odległość pomiędzy pikselami (P) określająca zalecaną odległość widzenia obrazu.

DIP

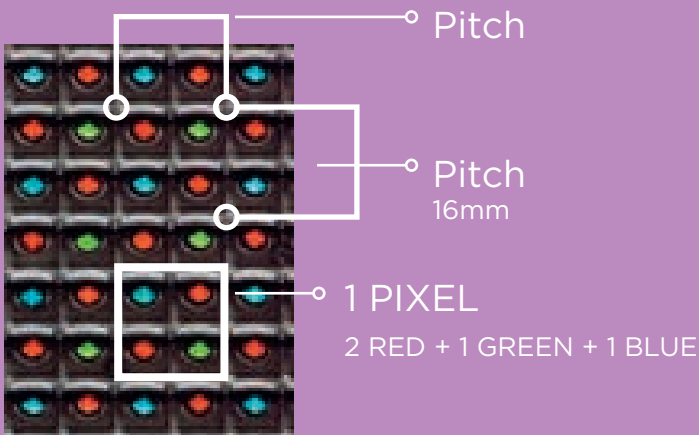

SMD

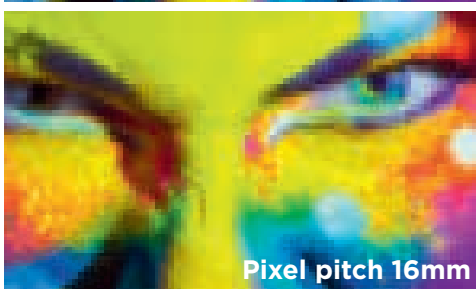
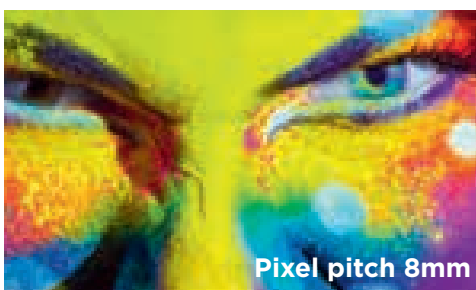
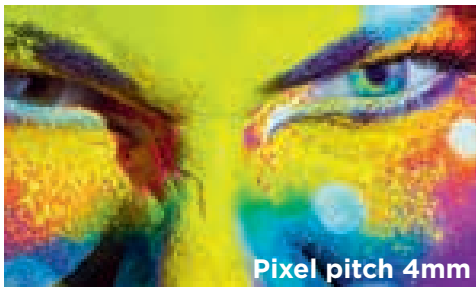
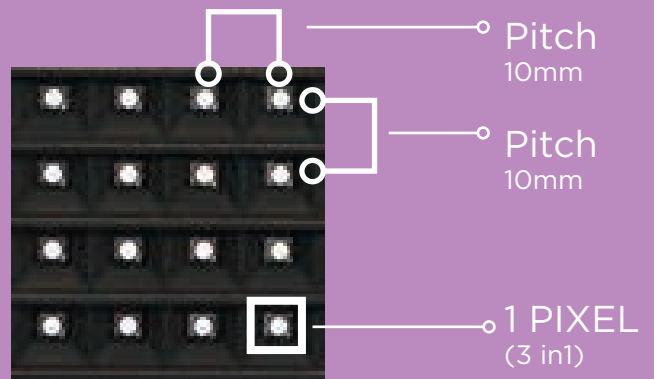

Con un P bajo, conseguimos más resolución y menor distancia de visionado.
With a low P, we gain a higher resolution and shorter viewing distance.
Si le P est bas, la résolution est supérieure et la distance de vision est inférieure.
Mit einem niedrigen Pixelabstand schafft man eine höhere Auflösung und eine kurze Blickdistanz.
Se il P è basso, la risoluzione è maggiore e la distanza di visione minore.
Com um P baixo, conseguimos mais resolução e menor distância de visualização.
Чем меньше шаг P, тем выше разрешение изображения и тем меньше должно быть расстояние для его восприятия.
Przy małym P, uzyskujemy większą rozdzielczość i mniejszą odległość widzenia.



Con un P alto, conseguimos menor resolución y mayor distancia de visionado.
With a high P, we gain a lower resolution and greater viewing distance.
Si le P est élevé, la résolution est inférieure et la distance de visionnage est plus grande.
Mit einem hohen Pixelabstand schafft man eine niedrige Auflösung und eine große Blickdistanz.
Se il P è alto, la risoluzione è minore e la distanza di visione maggiore.
Com um P alto, conseguimos menor resolução e maior distância de visualização.
Чем больше шаг P, тем ниже разрешение изображения и тем больше должно быть расстояние между изображением и зрителем.
Przy dużym P, uzyskujemy niższą rozdzielczość i większą odległość widzenia.

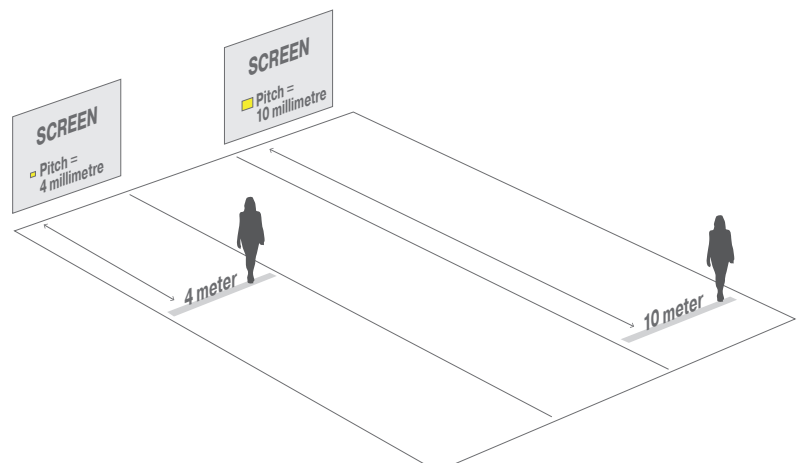

05 ¿QUÉ ES EL BRILLO (Luminancia)?

WHAT IS BRIGHTNESS (Luminance)?
QU'EST-CE QUE LA BRILLANCE (Luminance)?
Was gibt die Helligkeit an (Leuchtdichte)?
CHE COS'È LA (Luminanza)?
O QUE É O BRILHO (Luminância)?
ЧТО ТАКОЕ ЯРКОСТЬ?
CO TO JEST JASNOŚĆ (Luminancja)?

Es el flujo luminoso que emerge de una superficie siguiendo una dirección determinada. La luminancia es medida en NITS o candela/m².

It's the flow of light emerging from a surface in a given direction. Luminance is measured in NITS or candelas/m².

C'est le flux lumineux qui émerge d'une surface en suivant une direction déterminée. La luminance se mesure en NITS ou candela/m² (cd/m²).

Die Leuchtdichte liefert detaillierte Information über die Orts- und Richtungsabhängigkeit des von einem unendlich kleinen Flächenelement abgegebenen Lichtstroms. Die Leuchtdichte wird in Nit oder Candela/m² ausgedrückt (1 Nit = 1 cd/m²).

Il flusso luminoso che emerge da una superficie seguendo una determinata direzione. La luminanza si misura in NITS o cd/m².

É o fluxo luminoso que emerge de uma superfície, seguindo uma direção determinada. A luminância é medida em NITS ou candela/m².

Яркостью называется поток света, излучаемый поверхностью в заданном направлении. Единица измерения яркости НИТ или кнд/м².

Jest to strumień światła emitowany z powierzchni w danym kierunku. Jasność mierzona jest w NITACH lub kandelach/m².

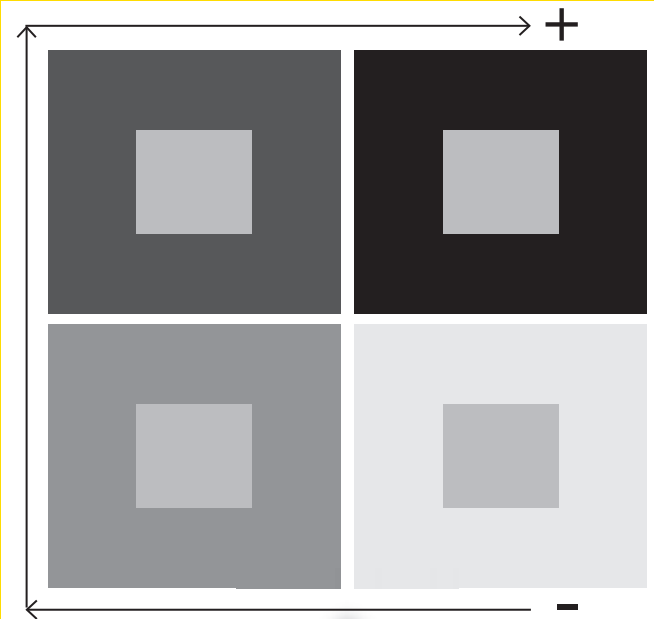
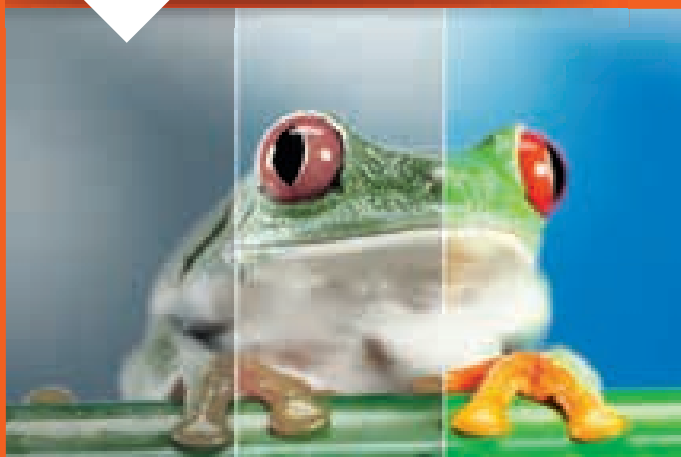

Es la diferencia relativa de intensidad entre un punto de una imagen y sus alrededores, en nuestro caso el fondo de la pantalla.

It is the relative difference in intensity between a certain point in an image and its surroundings - in this case the screen background.

La différence relative d'intensité entre un point d'une image et son entourage, en l'occurrence le fond de l'écran.

Ist der relative Intensitätsunterschied zwischen einem Bildpunkt und seiner Umgebung, in unserem Fall dem Displayhintergrund.

La differenza relativa di intensità tra un punto di un'immagine e ciò che vi è intorno, nel nostro caso lo sfondo dello schermo.

A diferença relativa de intensidade entre um ponto de uma imagem e o seu redor, no nosso caso, o fundo do ecrã.

Контраст определяется как отношение яркости между некоторой точкой изображения на экране и окружающим ее фоном, в нашем случае – экраном.

Kontrast definiowany jest jako względna różnica pomiędzy jednym punktem obrazu i jego otoczeniem, a w naszym przypadku tłem ekranu.

06 ¿QUÉ ES EL CONTRASTE?

WHAT IS CONTRAST?
QU'EST-CE QUE LE CONTRASTE?
WAS BEDEUTET KONTRAST?
CHE COS'È IL CONTRASTO?
O QUE É O CONTRASTE?
ЧТО ТАКОЕ КОНТРАСТ?
CO TO JEST KONTRAST?

07

¿CÓMO ESCOGER EL BRILLO NECESARIO DE UNA PANTALLA?

HOW DO I CHOOSE THE NECESSARY BRIGHTNESS OF A SCREEN?
COMMENT CHOISIR LA BRILLANCE D'UN ÉCRAN?
WIE WÄHLE ICH DIE GEEIGNETE HELLIGKEIT EINES DISPLAYS AUS?
SCEGLIERE LA LUMINOSITÀ COME DI UNO SCHERMO?
COMO ESCOLHER O BRILHO NECESSÁRIO DE UM ECRÃ?
КАК ВЫБРАТЬ ОПТИМАЛЬНУЮ ЯРКОСТЬ ДЛЯ ЭКРАНА?
WYBIERANIE NIEZBĘDNEJ JASNOŚCI EKRANU?



NIT = CD/M²



LEDMOTION – ДИНАМИЧНОЕ СВЕТОДИОДНОЕ ОСВЕЩЕНИЕ

Transformamos la luz a través de diferentes y novedosos materiales integrados a la arquitectura para obtener espacios únicos y sorprendentes. Creamos iluminaciones personalizables a las emociones y estados de ánimo de las personas.

We use different and innovative materials integrated in the architecture to transform light. The result of this are unique and astonishing spaces. We create lighting which can be personalised to every person's feelings and moods.

Nous transformons la lumière à travers différents matériaux innovants et intégrés à l'architecture pour obtenir des espaces uniques et surprenants. Nous créons des éclairages qui s'adaptent aux émotions et aux états d'esprit des personnes.

Wir verwenden verschiedene neuartige in die Architektur integrierte Materialien, um das Licht zu transformieren und einzigartige, originelle Räume zu schaffen. Wir gestalten individuelle Beleuchtungslösungen, die sich an Anlass und Stimmung anpassen lassen.

Trasformiamo la luce attraverso materiali diversi ed innovativi, integrati nell'architettura, per ottenere spazi unici e straordinari. Creiamo illuminazioni personalizzabili in base alle emozioni ed agli stati d'animo delle persone.

Transformamos a luz através de materiais diferentes e inovadores, integrados na arquitetura de forma a obter espaços únicos e surpreendentes. Criamos iluminações que se adaptam às emoções e ao estado de espírito das pessoas.

Мы трансформируем свет с помощью различных современных материалов, интегрированных в архитектурное решение, чтобы создавать уникальные и удивительные пространства. Мы предлагаем освещение, подстраивающееся под ваш эмоциональный фон и настроение.

Używamy różnorodnych i nowoczesnych materiałów w architekturze, aby kształtować światło. Jako rezultat otrzymujemy jedyne w swoim rodzaju, zaskakujące przestrzenie. Tworzymy oświetlenie, które można ustawić pod nastrój i humor każdego użytkownika.

01.

02.

03.

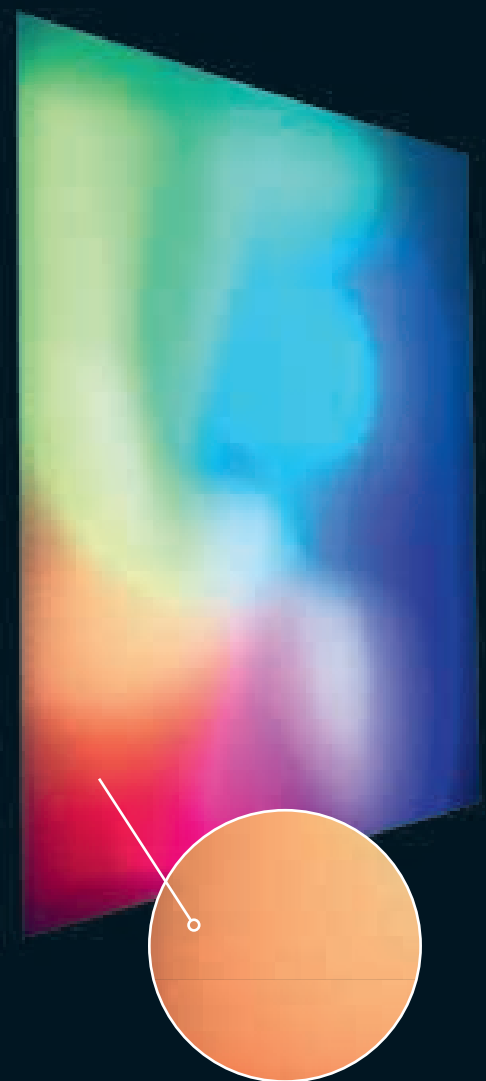
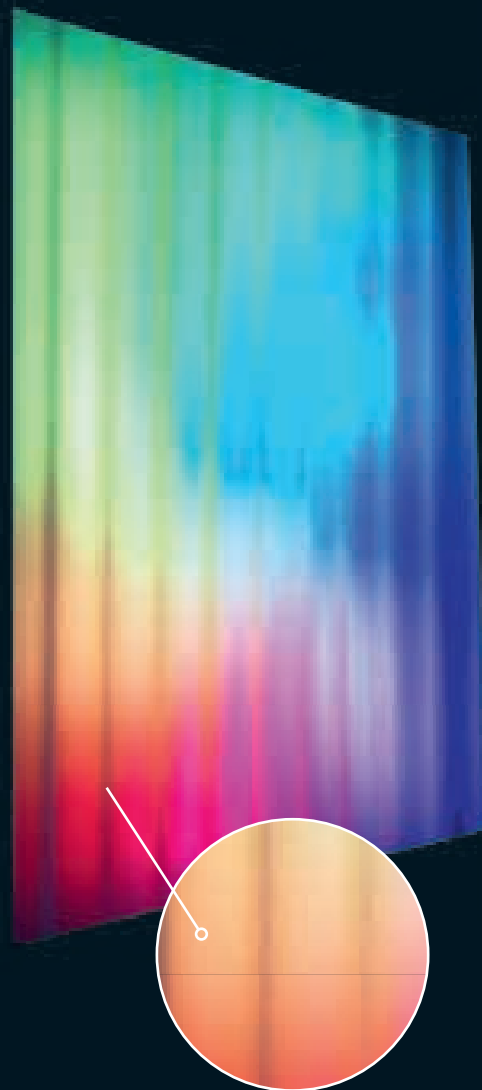
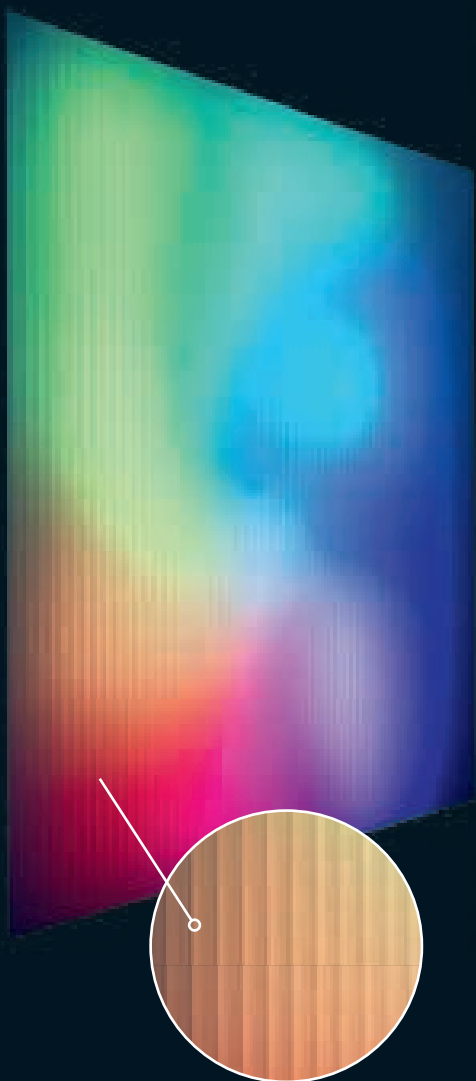

- 01. STRIPE
- 02. WAVE
- 03. ICE
- 04. AQUA
- 05. POINT
- 06. PRISMA

04.

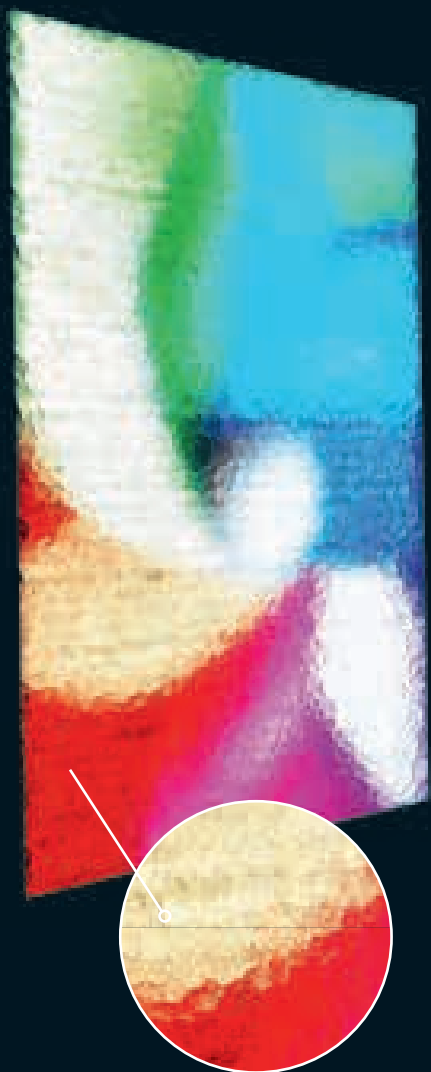

05.

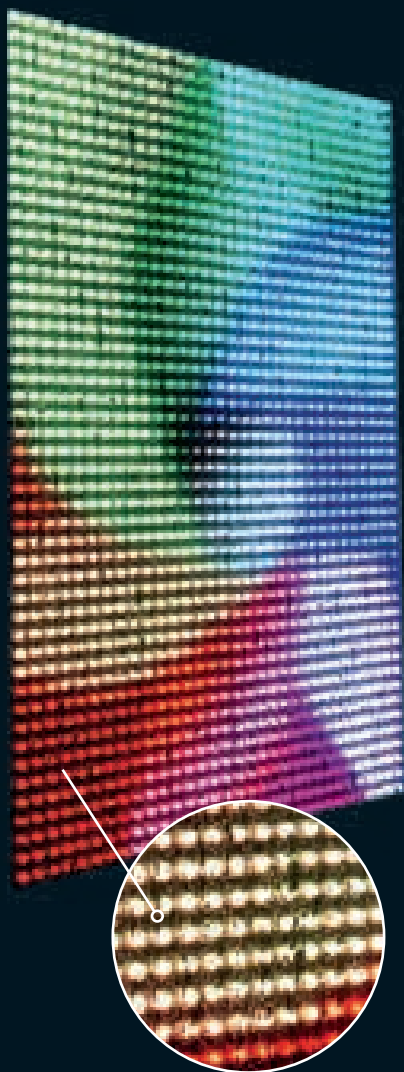

06.

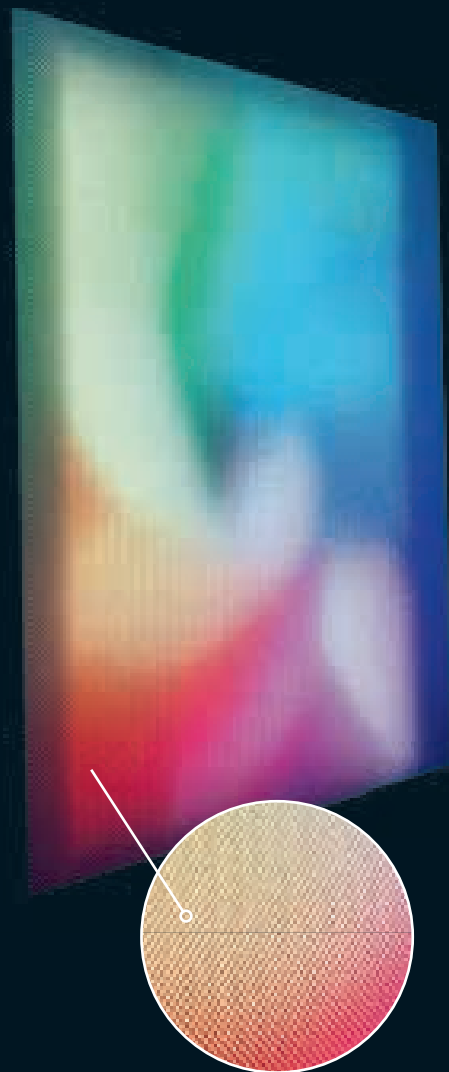

07. SAND

08. MOSAIC

09. LAYERS

10. VITRO

11. FOGGY

12. CELULAR

07.



08.

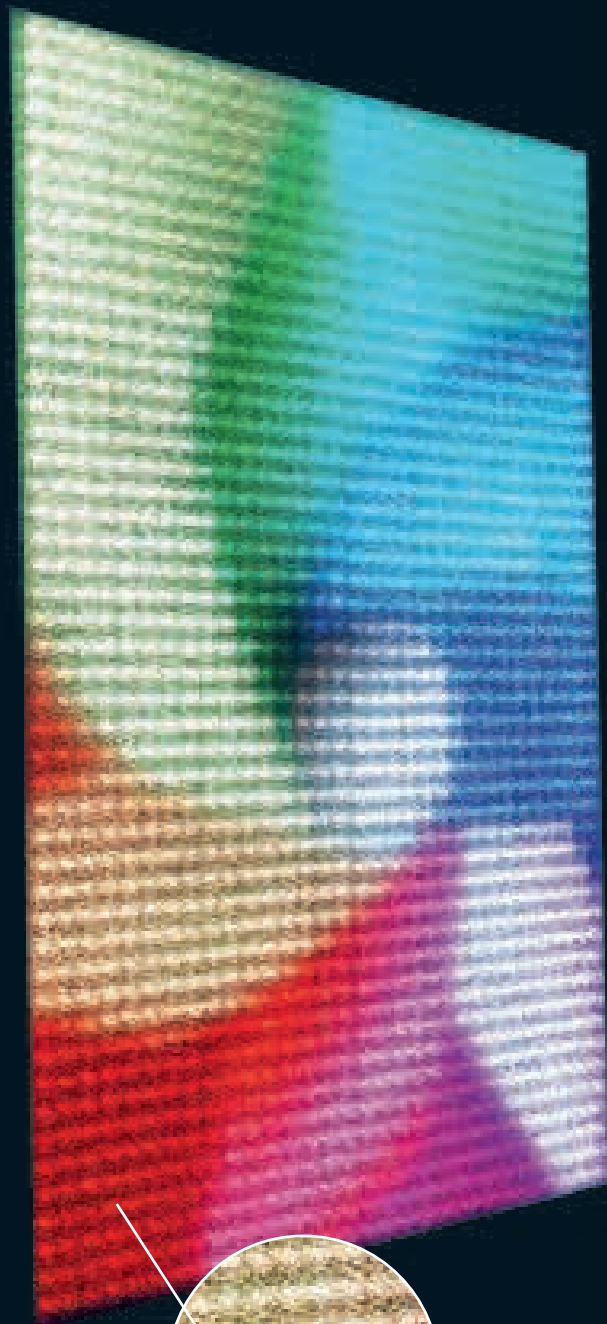

09.

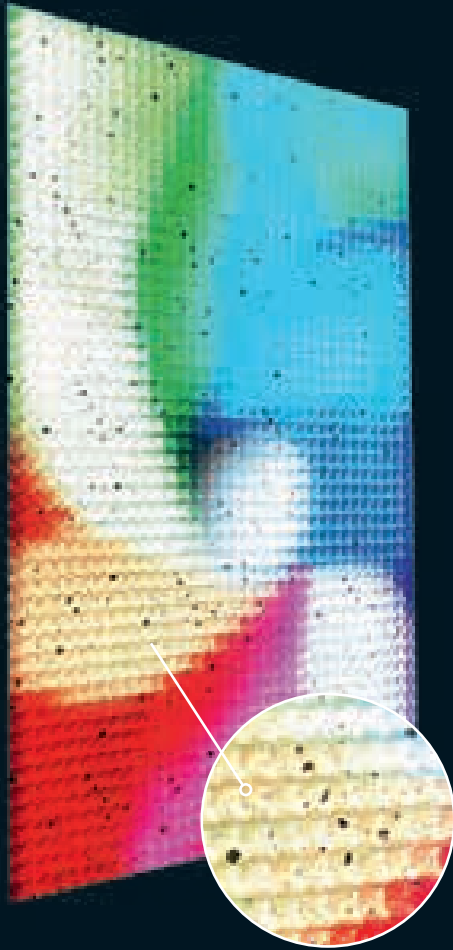

10.

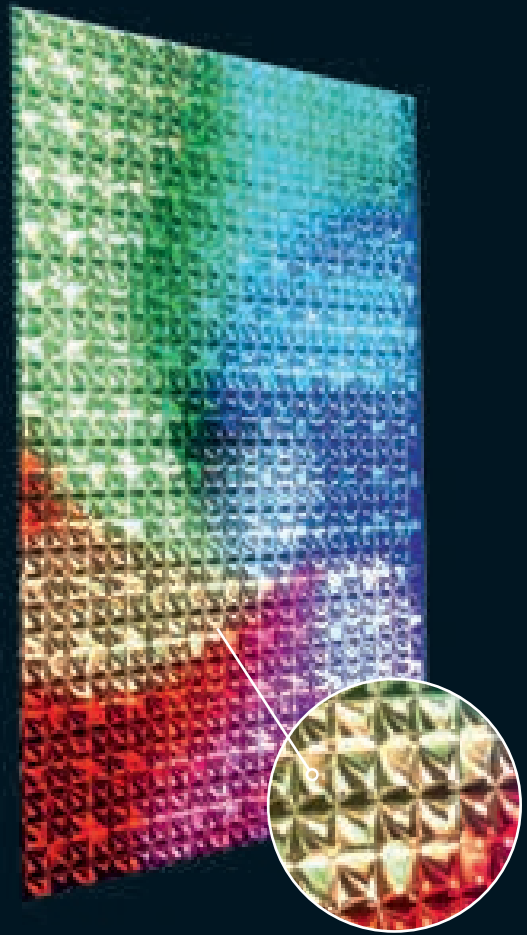

11.

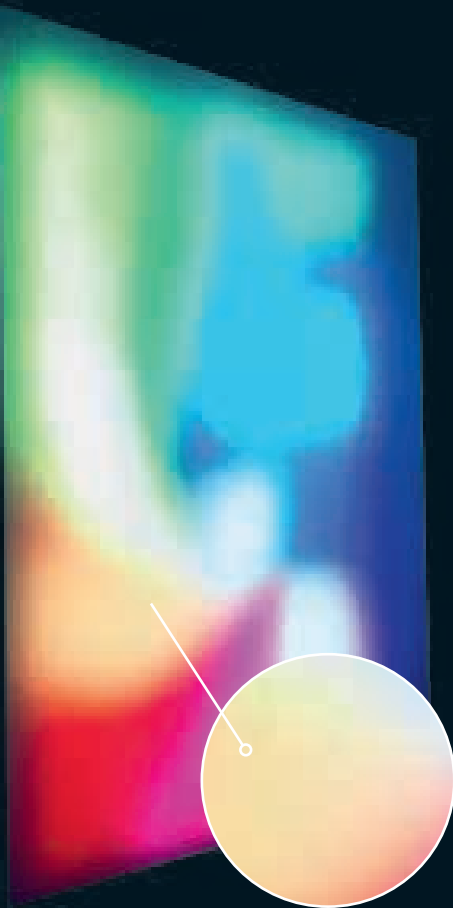

12.

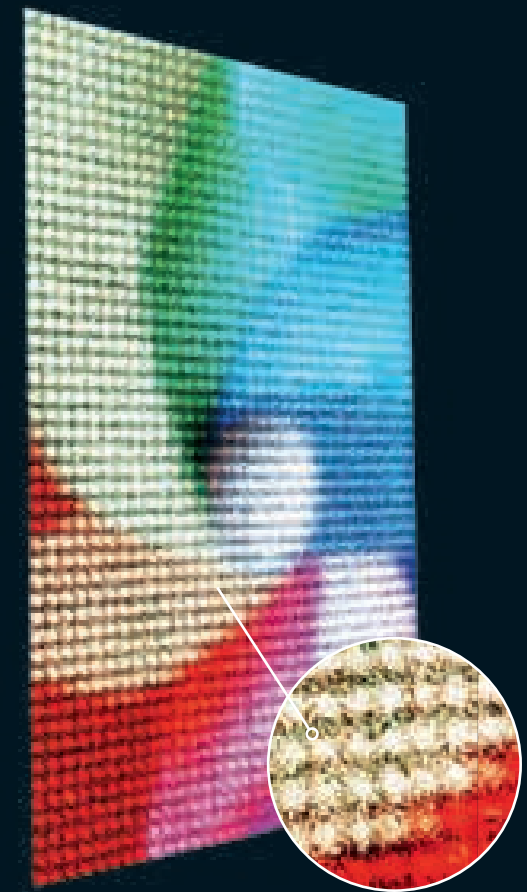

DOTS

PUNTOS
POINTS LUMINEUX
PUNKTE
PUNTI
PONTOS
TOЧКИ
PUNKTY

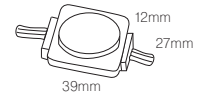
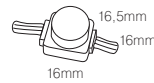
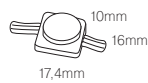

	NO-1	NO-2	NO-3
--	------	------	------



	NO-1	NO-2	NO-3	
ESPECIFICACIONES DEL PIXEL PIXEL PARAMETER CARACTERÍSTICAS DU PIXEL PIXEL-SPEZIFIKATIONEN CARATTERISTICHE DEL PIXEL ESPECIFICAÇÕES DO PIXEL ХАРАКТЕРИСТИКИ ПИКСЕЛЕЙ SPECIFICACIA PIXELSI	n° Led 1	1	3	
	SMD 3 in 1 SMD 3535 / RGB (3 IN 1)	SMD 3535 / RGB (3 IN 1)	SMD 3535 / RGB (3 IN 1)	SMD 3535 / RGB (3 IN 1)
	0,3W /DOT 0,3W /DOT	0,3W /DOT	0,3W /DOT	0,72W /DOT
	5 VDC 5 VDC	5 VDC	5 VDC	12 VDC
ESPECIFICACIONES DEL MÓDULO MODULE SPECIFICATIONS CARACTERÍSTICAS DU MODULE MODUL-SPEZIFIKATIONEN CARATTERISTICHE DEL MÓDULO ESPECIFICAÇÕES DO MÓDULO ХАРАКТЕРИСТИКИ МОДУЛЯ SPECIFICACIA MODULU	40 40	40	50	
	LENSES - LENTES CLEAR FLAT	CLEAR FLAT	CLEAR BALL COVER	CLEAR FLAT
	HOUSING - CUERPO TRANSPARENT	TRANSPARENT	BLACK Optional: WHITE & GREY	BLACK Optional: WHITE & GREY
	COVER MATERIAL - MATERIAL DIFUSOR PC	PC	PC	PC
	HOUSING MATERIAL - MATERIAL DEL MÓDULO PC	PC	PC	PC
	8 g 8 g	8 g	8 g	12 g
	400 g 400 g	400 g	400 g	600 g
ESPECIFICACIONES ÓPTICAS OPTIC SPECIFICATIONS CARACTERÍSTICAS OPTIQUES SPEZIFIKATIONEN DER LENSEN SPECIFICAZIONI OTTICHE ESPECIFICAÇÕES ÓPTICAS ОПТИЧЕСКИЕ ХАРАКТЕРИСТИКИ SPECIFICACIA UKADU OPTYCZNEGO	PITCH 432 (8cm) 432 (8cm)	432 (8cm)	1296 (8cm)	
	120° 120°	120°	120°	
	4096 (12 bits) 4096 (12 bits)	4096 (12 bits)	4096 (12 bits)	4096 (12 bits)
	16,7M (24 bits) 16,7M (24 bits)	16,7M (24 bits)	16,7M (24 bits)	16,7M (24 bits)
ESPECIFICACIONES GENERALES Y ELÉCTRICAS GENERAL AND ELECTRIC SPECIFICATIONS CARACTERÍSTICAS GENERALES E ELÉCTRICAS ALLGEMEINE UND ELEKTRISCHE SPEZIFIKATIONEN CARATTERISTICHE GENERALI ED ELETTRICHE ESPECIFICAÇÕES GERAIS E ELÉTRICAS ОБЩИЕ И ЭЛЕКТРИЧЕСКИЕ ХАРАКТЕРИСТИКИ SPECIFICACIA OGÓLNA I ELEKTRYCZNA	-40 °C +60 °C -40 °C +60 °C	-40 °C +60 °C	-40 °C +60 °C	
	10%~90% RH 10%~90% RH	10%~90% RH	10%~90% RH	10%~90% RH
	50.000 50.000	50.000	50.000	50.000
	CONECT MODE - MODO DE CONEXIÓN SIGNAL+POWER	SIGNAL+POWER	SIGNAL+POWER	SIGNAL+POWER
	CONTROL SYSTEM - SISTEMA DE CONTROL Computer control and SD card control system	Computer control and SD card control system	Computer control and SD card control system	Computer control and SD card control system

DOTS

PUNTOS
POINTS LUMINEUX
PUNKTE
PUNTI
PONTOS
ТОЧКИ
PUNKTY

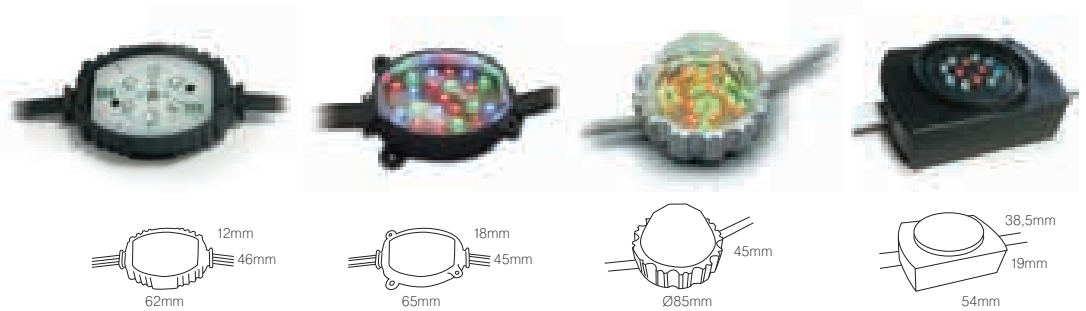

NO-4	NO-5	NO-6	NO-7

ESPECIFICACIONES DEL PÍXEL PIXEL PARAMETER CARACTERISTIQUES DU PÍXEL PIXEL-SPEZIFIKATIONEN CARATTERISTICHE DEL PÍXEL ESPECIFICAÇÕES DO PÍXEL ХАРАКТЕРИСТИКИ ПÍКСЕЛЕЙ SPECIFIKACIA PÍKSELI	ESPECIFICACIONES DEL MÓDULO MODULE SPECIFICATIONS CARACTERISTIQUES DU MODULE MÓDUL-SPEZIFIKATIONEN CARATTERISTICHE DEL MÓDULO ESPECIFICAÇÕES DO MÓDULO ХАРАКТЕРИСТИКИ МОДУЛЯ SPECIFIKACIA MODULU	ESPECIFICACIONES ÓPTICAS OPTIC SPECIFICATIONS CARACTERISTIQUES OPTIQUES SPEZIFIKATIONEN DER LENSEN SPEZIFIKAZIONI OTTICHE ESPECIFICAÇÕES ÓTICAS ОПТИЧЕСКИЕ ХАРАКТЕРИСТИКИ SPECIFIKACIA UKŁADU OPTYCZNEGO	ESPECIFICACIONES GENERALES Y ELÉCTRICAS GENERAL AND ELECTRIC SPECIFICATIONS CARACTERISTIQUES GÉNÉRALES ET ÉLECTRIQUES ALLGEMEINE UND ELEKTRISCHE SPEZIFIKATIONEN CARATTERISTICHE GENERALI ED ELETRICHE ESPECIFICAÇÕES GERAIS E ELÉTRICAS ОБЩІЕ І ЕЛЕКТРИЧЕСЬКІЕ ХАРАКТЕРИСТИКИ SPECIFIKACIA OGÓLNA ELEKTRYCZNA	
	8	24	12	12
	SMD 3535 / RGB (3 IN 1)	DIP 10R 7G 7B	SMD 3535 / RGB (3 IN 1)	DIP 346 / 4R 4G 4B
	1,5W /DOT	0,81W /DOT	2,88W /DOT	0,8W /DOT
	15 VDC	24 VDC	24 VDC	36V
	70	80	150	80
LENSES - LENTES	CLEAR FLAT	CLEAR FLAT COVER	CLEAR BALL COVER	CLEAR FLAT Optional: MILK WHITE
HOUSING - CUERPO	BLACK Optional: WHITE & GREY	BLACK Optional: WHITE & GREY	BLACK Optional: WHITE & GREY	BLACK Optional: WHITE & GREY
COVER MATERIAL - MATERIAL DIFUSOR				
HOUSING MATERIAL - MATERIAL DEL MÓDULO	Optional:			
	12 g	12 g	115 +/-5g	12 g
	750 g	750 g	6,1 Kg	750 g
PITCH	1728 (8cm)	5600 (10cm)	2765 (15cm)	4032 (8cm)
	120°	90°	120°	90°
	4096 (12 bits)	4096 (12 bits)	256	4096
	16,7M (24 bits)	16,7M (24 bits)	16,7M (24 bits)	16,7M (24 bits)
	-40 °C +60 °C	-40 °C +60 °C	-40 °C +60 °C	-40 °C +60 °C
	10%~90% RH	10%~90% RH	10%~90% RH	10%~90% RH
	50.000	50.000	50.000	50.000
	CONNECT MODE - MODO DE CONEXIÓN	SIGNAL+POWER	SIGNAL+POWER	SIGNAL+POWER
	CONTROL SYSTEM - SISTEMA DE CONTROL	Computer control and SD card control system	Computer control and SD card control system	Computer control and SD card control system



EMOTIONAL

FLEXIBLE CURTAINS

CORTINAS FLEXIBLES
 RIDEAUX FLEXIBLES
 FLEXIBLE VORHÄNGE
 TENDE FLESSIBILI
 CORTINAS FLEXÍVEIS
 ГИБКИЕ ЗАНАВЕСЫ
 ELASTYCZNE ZASŁONY



OC-12	OC-1875

ESPECIFICACIONES DEL PÍXEL PIXEL PARAMETER CARACTERÍSTICAS DEL PÍXEL CHARACTERISTICS DU PÍXEL MODUL-SPEZIFIKATIONEN CARATTERISTICHE DEL PÍXEL ESPECIFICAÇÕES DO PÍXEL ХАРАКТЕРИСТИКИ ПИКСЕЛЕЙ SPECYFIKACJA PÍKSELI			
	12	18,75	
	SMD 3528 / RGB (3 IN 1)	SMD 5050 / RGB (3 IN 1)	
	6.944	2.844	
ESPECIFICACIONES DEL MÓDULO MODULE SPECIFICATIONS CARACTERÍSTICAS DEL MÓDULO MODUL-SPEZIFIKATIONEN CARATTERISTICHE DEL MÓDULO ESPECIFICAÇÕES DO MÓDULO ХАРАКТЕРИСТИКИ МОДУЛЯ SPECYFIKACJA MODULU	MODUL RESOLUTION - RESOLUCIÓN DEL MÓDULO	16 X 80	16 X 48
	HOUSING MATERIAL - MATERIAL DEL MÓDULO		
		1,5	2,5
		60W	72W
CONTROLLER SPECIFICATIONS ESPECIFICACIONES DEL CONTROLADOR CARACTERÍSTICAS DU CONTRÔLEUR SPEZIFIKATIONEN DER STEUERUNG CARATTERISTICHE DEL REGOLATORE ESPECIFICAÇÕES DO CONTROLADOR ХАРАКТЕРИСТИКИ КОНТРОЛЕРА SPECYFIKACJA STEROWNIKA	CONTROLLER DIMENSIONS - MEDIDAS DEL CONTROLADOR (L*W*H) (mm)	535 X 200 X 100	535 X 200 X 100
	CONTROLLER MATERIAL - MATERIAL DEL CONTROLADOR		
		13	13
		326W /m²	391W /m²
	QUANTITY OF CONTROLLED MODULES - Nº MÓDULOS CONTROLADOS	4 X 4 2 X 9	4 X 4 2 X 8
	QUANTITY OF CONTROLLED PIXELS - Nº PÍXELES CONTROLADOS (L X H)	64 X 320 32 X 720	64 X 192 32 X 384
	CONTROLLED AREA DIMENSIONS - DIMENSIONES AREA CONTROLADA (L*H) (mm)	768 X 3840 384 X 8640	1200 X 7200 600 X 3600
	ESPECIFICACIONES ÓPTICAS OPTIC SPECIFICATIONS CARACTERÍSTICAS OPTIQUES SPEZIFIKATIONEN DER LENSEN SPECIFICAZIONI OTTICHE ESPECIFICAÇÕES ÓTICAS ОПТИЧЕСКИЕ ХАРАКТЕРИСТИКИ SPECYFIKACJA UKŁADU OPTYCZNEGO	12 - 20	19 - 25
		110°	110°
			2800
		65536	16384
Mhz		2000	1000
Bit		16	16
		16,7M (24 bits)	16,7M (24 bits)
ESPECIFICACIONES GENERALES Y ELÉCTRICAS GENERAL AND ELECTRIC SPECIFICATIONS CARACTERÍSTICAS GÉNÉRALES ET ÉLECTRIQUES ALLGEMEINE UND ELEKTRISCHE SPEZIFIKATIONEN CARATTERISTICHE GENERALI ED ELETTRICHE ESPECIFICAÇÕES GERAIS E ELÉTRICAS ОБЩИЕ И ЭЛЕКТРИЧЕСКИЕ ХАРАКТЕРИСТИКИ SPECYFIKACJA OGÓLNA I ELEKTRYCZNA	°C	-20 °C ~+50 °C	-20 °C ~+50 °C
		10%~90% RH	10%~90% RH
		≥ 30.000	≥ 30.000
		110/220 VAC +/- 15%	110/220 VAC +/- 15%
		47/63 Hz	47/63 Hz
	SIGNAL TRANSFER - TRANSMISIÓN DE SEÑAL	LAN Cable	LAN Cable
CONTROL SYSTEM - SISTEMA DE CONTROL	Computer control	Computer control	

FLEXIBLE CURTAINS

CORTINAS FLEXIBLES
RIDEAUX FLEXIBLES
FLEXIBLE VORHÄNGE
TENDE FLESSIBILI
CORTINAS FLEXÍVEIS
ГИБКИЕ ЗАНАВЕСЫ
ELASTYCZNE ZASŁONY

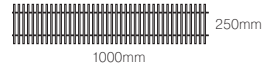
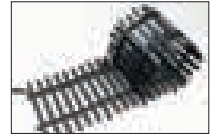
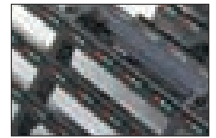

OC-3125-A

OC-3125-B



ESPECIFICACIONES DEL PÍXEL PIXEL PARAMETER CARACTERÍSTICAS DEL PÍXEL PIXEL SPECIFICATIONEN CARACTERISTICHE DEL PÍXEL ESPECIFICAÇÕES DO PÍXEL ХАРАКТЕРИСТИКИ ПИКСЕЛЕЙ SPECYFIKACJA PÍKSELU		
	31,25 mm	31,25
	DIP ø5 / 1R 1G 1B	DIP ø5 / 1R 1G 1B
	1.024	1.024
ESPECIFICACIONES DEL MÓDULO MODULE SPECIFICATIONS CARACTERÍSTICAS DEL MÓDULO MODUL SPECIFICATIONEN CARACTERISTICHE DEL MÓDULO ESPECIFICAÇÕES DO MÓDULO ХАРАКТЕРИСТИКИ МОДУЛЯ SPECYFIKACJA MODULU	MODUL RESOLUTION - RESOLUCIÓN DEL MÓDULO 8 x 32	8 x 32
	HOUSING MATERIAL - MATERIAL DEL MÓDULO ABS / PC	ABS / PC
	2	2
	80W	80W
CONTROLLER DIMENSIONS - MEDIDAS DEL CONTROLADOR (L*W*H) (mm)	500 X 200 X 100	1000 X 200 X 100
CONTROLLER MATERIAL - MATERIAL DEL CONTROLADOR	ST	ST
	10	16
	434W /m²	434W /m²
QUANTITY OF CONTROLLED MODULES - Nº MÓDULOS CONTROLADOS	2 X 4	4 X 4
QUANTITY OF CONTROLLED PIXELS - Nº PÍXELES CONTROLADOS (L X H)	16 x 128	32 x 128
CONTROLLED AREA DIMENSIONS - DIMENSIONES AREA CONTROLADA (L*H) (mm)	500 X 4000	1000 X 4000
ESPECIFICACIONES ÓPTICAS OPTIC SPECIFICATIONS CARACTERÍSTICAS ÓPTICAS SPECIFICATIONEN DER LINSEN SPECIFICAZIONE OTTICHE ESPECIFICAÇÕES ÓTICAS ОПТИЧЕСКИЕ ХАРАКТЕРИСТИКИ SPECYFIKACJA UKŁADU OPTYCZNEGO	30 - 33° 110° 4000 4096 Mhz 600 Bit 16 16,7M (24 bits)	30 - 33 110° 4000 4096 600 16 16,7M (24 bits)
ESPECIFICACIONES GENERALES Y ELÉCTRICAS GENERAL AND ELECTRIC SPECIFICATIONS CARACTERÍSTICAS GENERALES Y ELÉCTRICAS ALLGEMEINE UND ELEKTISCHE SPECIFICATIONEN CARACTERISTICHE GENERALI E ELÉCTRICAS ESPECIFICAÇÕES GERAIS E ELÉCTRICAS ОБЩИЕ И ЭЛЕКТРИЧЕСКИЕ ХАРАКТЕРИСТИКИ SPECYFIKACJA OGÓLNA I ELEKTRYCZNA	-20 °C ~+50 °C 10%~90% RH ≥ 30.000 110/220 VAC +/- 15% 47/63 Hz	-20 °C ~+50 °C 10%~90% RH ≥ 30.000 110/220 VAC +/- 15% 47/63 Hz
SIGNAL TRANSFER - TRANSMISIÓN DE SEÑAL	LAN Cable	LAN Cable
CONTROL SYSTEM - SISTEMA DE CONTROL	Computer control	Computer control



OUTDOOR DISPLAY

PANTALLA EXTERIOR
ÉCRAN D'EXTÉRIEUR
AUSSEN DISPLAY
SCHERMO ESTERNO
EKRAN EXTERIOR
ЭКРАНЫ ДЛЯ УЛИЧНОГО ПРИМЕНЕНИЯ
EKAN ZEWNETRZNY

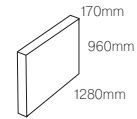
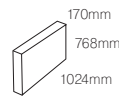
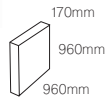

OD-10

OD-16

OD-20



	OD-10	OD-16	OD-20
ESPECIFICACIONES DEL PÍXEL PIXEL PARAMETER CARACTERÍSTICAS DEL PÍXEL PIXEL-SPEZIFIKACIONEN CARACTERISTICHE DEL PÍXEL ESPECIFICAZIÕES DO PÍXEL ХАРАКТЕРИСТИКИ ПИКСЕЛІВ SPECIFIKACJA PÍXELI	10 DIP346 / 1R - 1G - 1B 10.000	16 DIP546 / 2R - 1G - 1B 3.906	20 DIP546 / 2R - 1G - 1B 2.500
ESPECIFICACIONES DEL MÓDULO MODULE SPECIFICATIONS CARACTERÍSTICAS DO MÓDULO MÓDULO-SPEZIFIKACIONEN CARACTERISTICHE DEL MÓDULO ESPECIFICAZIÕES DO MÓDULO ХАРАКТЕРИСТИКИ МОДУЛЯ SPECIFIKACJA MODULU	CABINET MATERIAL - MATERIAL DEL MÓDULO ST 45 1250W/m ²	ALU /ST 35 1180W/m ²	ALU /ST 40 750W/m ²
ESPECIFICACIONES ÓPTICAS OPTIC SPECIFICATIONS CARACTERÍSTICAS ÓPTICAS SPEZIFIKACIONEN DEL LINSEN SPECIFICAZIÕES ÓPTICAS ОПТИЧЕКІЕ ХАРАКТЕРИСТИКИ SPECIFIKACJA ODDAJU OPTYCZNEGO	10 - 15 120° 60° 6500 4096 500 16 16,7M (24 bits)	16 - 20 120° 60° 6000 4096 500 16 16,7M (24 bits)	20 - 25 120° 60° 5500 4096 500 16 16,7M (24 bits)
ESPECIFICACIONES GENERALES Y ELÉCTRICAS GENERAL AND ELECTRIC SPECIFICATIONS CARACTERÍSTICAS GERAIS E ELÉCTRICAS ALLGEMEINE UND ELEKTISCHE SPEZIFIKACIONEN CARACTERISTICHE GERAIS E ELÉCTRICAS ESPECIFICAZIÕES GERAIS E ELÉCTRICAS ОБЩІЕ ІЗІЕКТРИЧЕКІЕ ХАРАКТЕРИСТИКИ SPECIFIKACJA OGÓLNA I ELEKTRYCZNA	-45 °C ~+60 °C 10%~90% RH ≥ 30.000 110/220 VAC +/- 15% 47/63 Hz SIGNAL TRANSFER - TRANSMISIÓN DE SEÑAL LAN Cable CONTROL SYSTEM - SISTEMA DE CONTROL Computer control	-45 °C ~+60 °C 10%~90% RH ≥ 30.000 110/220 VAC +/- 15% 47/63 Hz SIGNAL TRANSFER - TRANSMISIÓN DE SEÑAL LAN Cable CONTROL SYSTEM - SISTEMA DE CONTROL Computer control	-45 °C ~+60 °C 10%~90% RH ≥ 30.000 110/220 VAC +/- 15% 47/63 Hz SIGNAL TRANSFER - TRANSMISIÓN DE SEÑAL LAN Cable CONTROL SYSTEM - SISTEMA DE CONTROL Computer control

OUTDOOR TUBES

TUBOS EXTERIOR
 TUBES D'EXTÉRIEUR
 AUSSEN RÖHREN
 TUBI ESTERNI
 TUBOS DE EXTERIOR
 СВЕТОДИОДНЫЕ ТРУБКИ ДЛЯ УЛИЧНОГО ПРИМЕНЕНИЯ
 TUBY ZEWNĘTRZNE



LT-20



<p>ESPECIFICACIONES DEL PIXEL PIXEL PARAMETER CARACTERISTIQUES DU PIXEL PIXEL-SPEZIFIKATIONEN CARATTERISTICHE DEL PIXEL ESPECIFICACÕES DO PIXEL ХАРАКТЕРИСТИКИ ПИКСЕЛЕЙ SPECYFIKACJA PISELI</p>	<p> 1 mm</p> <p>20</p> <hr/> <p> SMD 3 in 1</p> <p>SMD 5050 / RGB (3 IN 1)</p> <hr/> <p> Leds/m²</p> <p>48</p>
<p>ESPECIFICACIONES DEL MÓDULO MODULE SPECIFICATIONS CARACTERISTIQUES DU MODULE MODUL-SPEZIFIKATIONEN CARATTERISTICHE DEL MÓDULO ESPECIFICACÕES DO MÓDULO ХАРАКТЕРИСТИКИ МОДУЛЯ SPECYFIKACJA MODULU</p>	<p>DIFFUSER COLOUR - COLOR DEL DIFUSOR</p> <p>TRANSPARENT Optional: WHITE</p> <hr/> <p>DIFFUSER MATERIAL - MATERIAL DIFUSOR</p> <p>PC</p> <hr/> <p>HOUSING MATERIAL - MATERIAL DEL MÓDULO</p> <p>ALU</p> <hr/> <p> 0,9</p> <hr/> <p> 12W /m</p> <hr/> <p> n° Led</p> <p>8 pixels (8 groups x 6 Leds)</p>
<p>ESPECIFICACIONES ÓPTICAS OPTIC SPECIFICATIONS CARACTERISTIQUES OPTIQUES SPEZIFIKATIONEN DEL LENSEN SPECIFICAZIONI OTTICHE ESPECIFICACÕES ÓTICAS ОПТИЧЕСКИЕ ХАРАКТЕРИСТИКИ SPECYFIKACJA UKŁADU OPTYCZNEGO</p>	<p> 20 - 25</p> <hr/> <p> 180°</p> <hr/> <p>FLUX (lm)</p> <p>300</p> <hr/> <p> Bit</p> <p>16</p> <hr/> <p> 24 Bit</p> <p>16,7M (24 bits)</p>
<p>ESPECIFICACIONES GENERALES Y ELÉCTRICAS GENERAL AND ELECTRIC SPECIFICATIONS CARACTERISTIQUES GÉNÉRALES ET ÉLECTRIQUES ALLGEMEINE UND ELEKTRIISCHE SPEZIFIKATIONEN CARATTERISTICHE GENERALI ED ELETTRICHE ESPECIFICACÕES GERAIS E ELÉTRICAS ОБЩИЕ И ЭЛЕКТРИЧЕСКИЕ ХАРАКТЕРИСТИКИ SPECYFIKACJA OGÓLNA I ELEKTRYCZNA</p>	<p> -45 °C ~+55 °C</p> <hr/> <p> 10%~90% RH</p> <hr/> <p> > 30.000</p> <hr/> <p> 24 vdc</p> <hr/> <p>CONNECTOR - CONECTOR</p> <p>SPI</p> <hr/> <p>CONECT MODE - MODO DE CONEXIÓN</p> <p>SIGNAL+POWER</p> <hr/> <p>CONTROL SYSTEM - SISTEMA DE CONTROL</p> <p>Computer control and SD card control system</p>



EMOTIONAL

INDOOR DISPLAY

PANTALLA INTERIOR
ÉCRAN D'INTÉRIEUR
INNEN DISPLAY
SCHERMO INTERNO
ECRĂ DE INTERIOR
ЭКРАНЫ ДЛЯ ИНТЕРЬЕРА ПОМЕЩЕНИЙ
EKAN WENWĘTRZNY

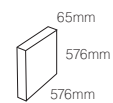
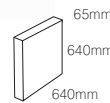
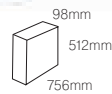

	ID-4	ID-5	ID-6
ESPECIFICACIONES DEL PÁVEL PANEL PARAMETER CARACTERÍSTICAS DEL PÁVEL PANEL-SPEZIFIKATIONEN CARATTERISTICHE DEL PÁVEL ESPECIFICAÇÕES DO PÁVEL ХАРАКТЕРИСТИКИ ПАНЕЛІВІ SPECYFIKACJA PANEU	4 mm SMD 2121 / RGB (3 IN 1) 62.500	5 SMD 3528 / RGB (3 IN 1) 40.000	6 SMD 3528 / RGB (3 IN 1) 27.889
ESPECIFICACIONES DEL MÓDULO MODULE SPECIFICATIONS CARACTERÍSTICAS DEL MÓDULO MODUL-SPEZIFIKATIONEN CARATTERISTICHE DEL MÓDULO ESPECIFICAÇÕES DO MÓDULO ХАРАКТЕРИСТИКИ МОДУЛІ SPECYFIKACJA MODULU	CABINET MATERIAL - MATERIAL DEL MÓDULO ALU 8 1300W/m ²	ALU 8 400W/m ²	ALU 7.5 300W/m ³
ESPECIFICACIONES ÓPTICAS OPTIC SPECIFICATIONS CARACTERÍSTICAS ÓPTICAS SPEZIFIKATIONEN DER LENSEN SPECIFICAZIONI OTTICHE ESPECIFICAÇÕES ÓPTICAS ОПТИЧЕСКИЕ ХАРАКТЕРИСТИКИ SPECYFIKACJA UKŁADU OPTYCZNEGO	4 - 8 140° 4000 65536 ≥ 2000 Mhz 16 Bit 16,7M (24 bits)	5 - 9 130° 4000 4096 4000 16 16,7M (24 bits)	6 - 10 130° 2500 4096 2000 16 16,7M (24 bits)
ESPECIFICACIONES GENERALES Y ELÉCTRICAS GENERAL AND ELECTRIC SPECIFICATIONS CARACTERÍSTICAS GENERALES ET ÉLECTRIQUES ALLGEMEINE UND ELEKTRISCHE SPEZIFIKATIONEN CARATTERISTICHE GENERALI ED ELETTRICHE ESPECIFICAÇÕES GERAIS E ELÉTRICAS ОБЩІЕ І ЕЛЕКТРИЧНІ ХАРАКТЕРИСТИКИ SPECYFIKACJA OGÓLNA I ELEKTRYCZNA	-20 °C ~+60 °C 10%~90% RH ≥ 30.000 110/220 VAC +/- 15% 47/63 Hz SIGNAL TRANSFER - TRANSMISIÓN DE SEÑAL CONTROL SYSTEM - SISTEMA DE CONTROL	-20 °C ~+60 °C 10%~90% RH ≥ 30.000 110/220 VAC +/- 15% 47/63 Hz LAN Cable Computer control	-20 °C ~+60 °C 10%~90% RH ≥ 30.000 110/220 VAC +/- 15% 47/63 Hz LAN Cable Computer control

INDOOR DISPLAY

PANTALLA INTERIOR
ÉCRAN D'INTÉRIEUR
INNEN DISPLAY
SCHERMO INTERNO
ECRĂ DE INTERIOR
ЭКРАНЫ ДЛЯ ИНТЕРЬЕРА ПОМЕЩЕНИЙ
EKAN WEWNĘTRZNY



ID-762

ID-10



ESPECIFICACIONES DEL PÍXEL PIXEL PARAMETER CARACTERÍSTICAS DEL PÍXEL PIXEL-SPEZIFIKATIONEN CARATTERISTICHE DEL PÍXEL ESPECIFICAÇÕES DO PÍXEL ХАРАКТЕРИСТИКИ ПИКСЕЛЕЙ SPECYFIKACJA PÍKSELI	7,62 mm	10
	SMD 3528 / RGB (3 IN 1)	SMD 3528 / RGB (3 IN 1)
	17.222 Leds/m²	10.000
ESPECIFICACIONES DEL MÓDULO MODULE SPECIFICATIONS CARACTERÍSTICAS DEL MÓDULO MODUL-SPEZIFIKATIONEN CARATTERISTICHE DEL MÓDULO ESPECIFICAÇÕES DO MÓDULO ХАРАКТЕРИСТИКИ МОДУЛЯ SPECYFIKACJA MODUŁU	CABINET MATERIAL - MATERIAL DEL MÓDULO ALU	ALU
	13	25
	600W/m²	440W/m²
ESPECIFICACIONES ÓPTICAS OPTIC SPECIFICATIONS CARACTERÍSTICAS ÓPTICAS SPEZIFIKATIONEN DER LENSEN SPECIFICAZIONI OTTICHE ESPECIFICAÇÕES ÓPTICAS ОПТИЧЕСКИЕ ХАРАКТЕРИСТИКИ SPECYFIKACJA UKŁADU OPTYCZNEGO	8 - 12 130° 2000 4096 Mhz 400 Bit 16 24 Bit 16,7M (24 bits)	10 - 15 130° 1100 4096 400 16 16,7M (24 bits)
	-20 °C ~+60 °C	-20 °C ~+60 °C
	10%~90% RH	10%~90% RH
	≥ 30.000	≥ 30.000
	110/220 VAC +/- 15%	110/220 VAC +/- 15%
	Hz 47/63 Hz	47/63 Hz
	SIGNAL TRANSFER - TRANSMISIÓN DE SEÑAL LAN Cable	LAN Cable
	CONTROL SYSTEM - SISTEMA DE CONTROL Computer control	Computer control



LED FLOOR

SUELO LED
SOL LED
LED BODENEINBAU
PAVIMENTO LED
LED DE CHÃO
СВЕТОДИОДНЫЙ ПОЛ
PODŁOGA LED

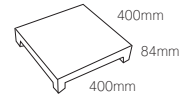
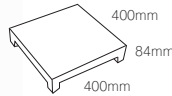

DF-20

DF-25



ESPECIFICACIONES DEL PÍXEL PIXEL PARAMETER CARACTERISTIQUES DU PÍXEL PIXEL-SPEZIFIKATIONEN CARATTERISTICHE DEL PÍXEL ESPECIFICAÇÕES DO PÍXEL ХАРАКТЕРИСТИКИ ПÍКСЕЛЕЙ SPECYFIKACJA PÍKSELI		
	20 mm	25
	SMD 3528 / RGB (3 IN 1)	SMD 3528 / RGB (3 IN 1)
	2.500	1.600
ESPECIFICACIONES DEL MÓDULO MODULE SPECIFICATIONS CARACTERISTIQUES DU MODULE MODUL-SPEZIFIKATIONEN CARATTERISTICHE DEL MÓDULO ESPECIFICAÇÕES DO MÓDULO ХАРАКТЕРИСТИКИ МОДУЛЯ SPECYFIKACJA MODULU	DIFFUSER COLOUR - COLOR DEL DIFUSOR	FRO white
	DIFFUSER MATERIAL- MATERIAL DIFUSOR	ACR (UV)
	HOUSING MATERIAL - MATERIAL DEL MÓDULO	ST
	8	8
	500	500
	188W /m²	125W /m²
ESPECIFICACIONES ÓPTICAS OPTIC SPECIFICATIONS CARACTERISTIQUES OPTIQUES SPEZIFIKATIONEN DER LINSEN SPECIFICAZIONI OTTICHE ESPECIFICAÇÕES ÓTICAS ОПТИЧЕСКІЕ ХАРАКТЕРЫСТЫКІ SPECYFIKACJA UKŁADU OPTYCZNEGO	vertical	135°
	horizontal	135°
	Color	2200
	Mhz	400
	Bit	16
	16,7M (24 bits)	16,7M (24 bits)
ESPECIFICACIONES GENERALES Y ELÉCTRICAS GENERAL AND ELECTRIC SPECIFICATIONS CARACTERISTIQUES GÉNÉRALES ET ÉLECTRIQUES ALLGEMEINE UND ELEKTRISCHE SPEZIFIKATIONEN CARATTERISTICHE GENERALI ED ELETTICHE ESPECIFICAÇÕES GERAIS E ELÉTRICAS ОБЩІЕ ІІ ЭЛЕКТРИЧЕСКІЕ ХАРАКТЕРЫСТЫКІ SPECYFIKACJA OGÓLNA I ELEKTRYCZNA	°C	-45 °C ~+60 °C
	RH	10%~90% RH
	LIFE	≥ 30.000
	VAC	180-240 VAC
	Hz	47/63 Hz
	SIGNAL TRANSFER - TRANSMISIÓN DE SEÑAL	LAN Cable
CONTROL SYSTEM - SISTEMA DE CONTROL	Computer control	Computer control

LED FLOOR

SUELO LED
SOL LED
LED BODENEINBAU
PAVIMENTO LED
LED DE CHÃO
СВЕТОДИОДНЫЙ ПОЛ
PODŁOGA LED

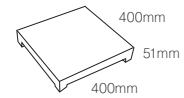
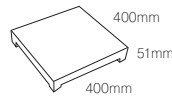
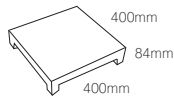

DF-50-A

DF-50-B

DF-50-C



	DF-50-A	DF-50-B	DF-50-C
ESPECIFICACIONES DEL PÍXEL PIXEL PARAMETER CARACTERÍSTICAS DEL PÍXEL PIXEL SPEZIFIKATIONEN PIXEL SPECIFIKATIONEN ПАРАМЕТРЫ ПИКСЕЛЯ СПЕЦИФИКАЦИЯ ПИКСЕЛЯ	50 SMD 3528 / RGB (3 IN 1) 400	50 SMD 5050 / RGB (3 IN 1) 400	50 SMD 5050 / RGB (3 IN 1) 400
ESPECIFICACIONES DEL MÓDULO MODULE SPECIFICATIONS CARACTERÍSTICAS DEL MÓDULO MODULE SPEZIFIKATIONEN MODULE SPECIFIKATIONEN ХАРАКТЕРИСТИКИ МОДУЛЯ СПЕЦИФИКАЦИЯ МОДУЛЯ	DIFFUSER COLOUR - COLOR DEL DIFUSOR FRO white DIFFUSER MATERIAL - MATERIAL DIFUSOR ACR (UV) HOUSING MATERIAL - MATERIAL DEL MÓDULO ST 8 500 82W /m²	SMOKED GLA Toughened ST 9 500 82W /m²	SMOKED GLA Toughened ST 9 500 82W /m²
ESPECIFICACIONES ÓPTICAS OPTIC SPECIFICATIONS CARACTERÍSTICAS ÓPTICAS OPTIK SPEZIFIKATIONEN OPTIK SPECIFIKATIONEN ОПТИЧЕСКИЕ ХАРАКТЕРИСТИКИ СПЕЦИФИКАЦИЯ ОПТИКИ	135° 180° 1800 400 16 16,7M (24 bits)	130° 1000 1200 16 16,7M (24 bits)	130° 1000 1200 16 16,7M (24 bits)
ESPECIFICACIONES GENERALES Y ELÉCTRICAS GENERAL AND ELECTRIC SPECIFICATIONS CARACTERÍSTICAS GENERALES Y ELÉCTRICAS ALLGEMEINE UND ELEKTRISCHE SPEZIFIKATIONEN CHARAKTERISTISCHE GEMEINSAM ELEKTRISCHE SPEZIFIKATIONEN ОБЩИЕ И ЭЛЕКТРИЧЕСКИЕ ХАРАКТЕРИСТИКИ СПЕЦИФИКАЦИЯ ОБЩИХ И ЭЛЕКТРИЧЕСКИХ	-45 °C ~+60 °C 10%~90% RH ≥ 30.000 180-240 VAC 47/63 Hz SIGNAL TRANSFER - TRANSMISIÓN DE SEÑAL LAN Cable CONTROL SYSTEM - SISTEMA DE CONTROL Computer control	-45 °C ~+60 °C 10%~90% RH ≥ 30.000 180-240 VAC 47/63 Hz SIGNAL TRANSFER - TRANSMISIÓN DE SEÑAL LAN Cable CONTROL SYSTEM - SISTEMA DE CONTROL Interactive control system	-45 °C ~+60 °C 10%~90% RH ≥ 30.000 180-240 VAC 47/63 Hz SIGNAL TRANSFER - TRANSMISIÓN DE SEÑAL LAN Cable CONTROL SYSTEM - SISTEMA DE CONTROL Computer control



EMOTIONAL

CARACTERÍSTICAS GENERALES DE LA COTIZACIÓN EMOTIONAL LIGHTING

Software y sistema de control - INCLUIDO a no ser que se requiera lo contrario.

La estructura de fijación se incluirá o no dependiendo del tipo de proyecto existiendo la posibilidad de entregar los planos de esta para que el cliente la puede desarrollar.

Asesoramiento en obra - INCLUIDO. (Un técnico de LEDS-C4)

Montaje en obra - NO INCLUIDO a no ser que se requiera.

SE NECESITA LA SIGUIENTE INFORMACIÓN PARA LA COTIZACIÓN:

Descripción de la idea del proyecto.

¿Qué aplicación/es (suelo, pared, techo) tiene el proyecto?

¿Qué finalidad tiene el proyecto? ¿Video o LEDMOTION?

¿Distancia de visionado del proyecto?

¿Interior o Exterior?

¿Día y/o Noche?

¿Medidas?

Descripción de ubicación.

Dibujos y/o Renders de la instalación.

Presupuesto (opcional)

GENERAL FEATURES OF THE EMOTIONAL LIGHTING QUOTATION

Software and control system - INCLUDED unless not required by the customer

The fixing structure may or may not be included depending on the type of project. It is possible to hand in the drawings of this structure for the client to develop it.

On-site advice - INCLUDED. (LEDS-C4 engineer)

On-site set-up - NOT INCLUDED, unless needed.

THE FOLLOWING INFORMATION IS REQUIRED FOR QUOTATIONS:

Description of the project idea.

What is the application(s) (floor, wall, ceiling) of the project?

What is the purpose of the project? Video or LEDMOTION?

Viewing distance of the project?

Indoors or outdoors?

Day and/or night?

Measurements?

Location description.

Drawings and/or renders of the installation.

Budget (optional)

CARACTÉRISTIQUES GÉNÉRALES DE L'ESTIMATION EMOTIONAL LIGHTING

Logiciel et système de contrôle - FOURNI, sauf autre condition requise
La structure de fixation sera fournie ou non en fonction du type de projet, avec possibilité de livrer les plans de cette dernière pour que le client puisse la développer.

Conseil sur site - FOURNI (un technicien de Leds-C4)

Montage sur site - NON FOURNI sauf s'il s'avère nécessaire.

LES INFORMATIONS SUIVANTES SONT NÉCESSAIRES À L'ESTIMATION:

Description de l'idée du projet.

À quelle application (sol, mur, plafond) le projet est-il destiné ?

Quelle est la finalité du projet ? Vidéo ou LEDMOTION ?

Distance de visionnage du projet ?

Intérieur ou extérieur ?

Jour ou nuit ?

Dimensions ?

Description de l'emplacement.

Dessins et/ou rendus de l'installation.

Devis (en option)

ALLGEMEINE MERKMALE FÜR DAS KOSTENANGEBOT FÜR EMOTIONAL LIGHTING

Software und Steuersystem - ENTHALTEN, sofern nicht vom Kunden anders gewünscht

Ob die Befestigungselemente im Preis enthalten sind oder nicht, hängt von den Projektdetails ab. Es können die Pläne zur Verfügung gestellt werden, damit der Kunde sein eigenes Befestigungssystem entwerfen kann.

Beratung an der Baustelle - INKLUSIVE. (Techniker von LEDS-C4)

Montage an der Baustelle - NICHT ENTHALTEN, sofern nicht vom Kunden angefordert

ZUR ERSTELLUNG EINES KOSTENANGEBOTS SIND DIE FOLGENDEN ANGABEN NOTWENDIG:

Beschreibung des geplanten Bauprojekts.

Wo wird das Beleuchtungssystem angebracht (Boden, Wand, Decke)?

Einsatzzweck/Verwendung des fertigen Systems Video oder LEDMOTION?

Blickdistanz des Projekts

Innen oder Außen?

Tag und/oder Abend/Nacht

Maße

Beschreibung des Installationsorts

Zeichnungen und/oder Render der Installation

Zur Verfügung stehendes Budget / Kostenrahmen (optionell)

CARATTERISTICHE GENERALI DELL' EMOTIONAL LIGHTING

Software e sistema di controllo INCLUSO salvo diverse indicazioni.

La struttura di fissaggio verrà inclusa o no in base al tipo di progetto ed esiste la possibilità di consegnarne in modo che il cliente la possa assemblare.

Consulenza durante i lavori - INCLUSA. (Un tecnico di LEDS-C4)

Montaggio durante i lavori - NON INCLUSO a meno che non si richieda.

PER LA VALUTAZIONE SONO NECESSARIE LE SEGUENTI INFORMAZIONI:

Descrizione le diverse parti del progetto.

Quale/i applicazione/i (pavimento, muro, soffitto) prevede il progetto?

Quale finalità ha il progetto? Video o LEDMOTION?

La distanza di visualizzazione del progetto?

Per Interni o Esterni?

Giorno e/o Notte?

Misure?

Descrizione della localizzazione.

Disegni e/o Renders dell'installazione.

Preventivo (facoltativo)

CARACTERÍSTICAS GERAIS DA COTAÇÃO DE EMOTIONAL LIGHTING

Software e sistema de controlo - INCLUÍDO, exceto se existirem necessidades em contrário.

A estrutura de fixação será ou não incluída com base no tipo de projeto, existindo a possibilidade de entregar os planos da mesma para que o cliente a possa desenvolver.

Assistência em obra - INCLUÍDA. (Um técnico de Leds-c4)

Montagem em obra - NÃO INCLUÍDA, exceto se necessário.

SÃO NECESSÁRIAS AS SEGUINTE INFORMAÇÕES PARA A COTAÇÃO:

Descrição da ideia do projeto.

Que aplicações (solo, parede, tecto) tem o projeto?

Qual é a finalidade do projeto? Video ou LEDMOTION?

Qual é a distância de visualização do projeto?

Interior ou exterior?

Dia e/ou noite?

Medidas?

Descrição do local.

Desenhos e/ou Renders da instalação.

Orçamento (opcional)

ОБЩИЕ ХАРАКТЕРИСТИКИ СОСТАВЛЕНИЯ СМЕТ EMOTIONAL LIGHTING

Программное обеспечение и система контроля - ВКЛЮЧЕНЫ, если нет договоренности о противном.

Структура крепежа включена или не включена, в зависимости от типа проекта; существует возможность передачи планов этой системы, чтобы клиент мог сам ее спроектировать.

Консалтинг на месте работ - ВКЛЮЧЕН (один представитель технического персонала фирмы «LEDS-C4»)

Монтаж на месте работ - НЕ ВКЛЮЧЕН, если нет договоренности о противном

ДЛЯ СОСТАВЛЕНИЯ СМЕТЫ НЕОБХОДИМА СЛЕДУЮЩАЯ ИНФОРМАЦИЯ:

Описание идеи проекта.

Место крепления осветительных приборов (пол, стена, потолок)

Назначение проекта. Видео или свет с датчиком движения?

Каково расстояние для визуального восприятия проекта?

Для уличного применения или интерьера помещений?

Для дневного или ночного восприятия?

Размеры?

Описание местоположения

Рисунок и/или компьютерная визуализация инсталляции.

Смета (по выбору)

OGÓLNE CECHY WYCENY EMOTIONAL LIGHTING

Oprogramowanie i system sterowania - ZAWARTE chyba, że czegoś innego się wymaga.

Układ mocujący zostanie dołączony bądź nie w zależności od rodzaju projektu, istnieje możliwość przekazania jego planów tak, aby klient mógł go opracować.

Doradztwo na budowie - ZAWARTE. (Jeden technik firmy LEDS-C4)

Montaż na budowie - NIEZAWARTY chyba, że jest wymagany.

POTRZEBNE SĄ NASTĘPUJĄCE INFORMACJE DLA WYKONANIA WYCENY:

Opis pomysłu projektu.

Jakie zastosowanie/a (na podłodze, ścianie, suficie) ma ten projekt?

Jaki cel ma ten projekt? Film wideo czy LEDMOTION?

Odległość widzenia projektu?

Wewnątrz czy na zewnątrz?

W dzień i/lub w nocy?

Wymiary?

Opis położenia.

Rysunki i/lub renderowanie instalacji.

Ustalony budżet (do wyboru)





LAMPS

LÁMPARAS

LAMPES

LEUCHTMITTEL

LAMPADINE

LÂMPADAS

ЛАМПЫ

ŻARÓWK

AR LED

AR-111 G53 10W **AR-111 GU10 10W** **AR-111 G53 15W** **AR-111 GU10 15W**

10W = equivalente a as bright as 50w Halogen
15W = equivalente a as bright as 75w Halogen



AR-111 G53



AR-111 GU10



AR-111

		V	W	K		I (cd)	lm		
ACT-FLL-015	GU10	220-240	10	3000K	24°	4200	532	> 30000	
ACT-FLL-017	GU10	220-240	10	3000K	35°	2000	483	> 30000	



AR-111

		V	W	K		I (cd)	lm		
ACT-FLL-032	GU10	220-240	15	3000K	24°	6000	802	>30000	
ACT-FLL-033	GU10	220-240	15	3000K	35°	3000	892	>30000	



AR-111

		V	W	K		I (cd)	lm	
ACT-FLL-011	G53	12	10	3000K	24°	4200	532	> 30000
ACT-FLL-013	G53	12	10	3000K	35°	2000	483	> 30000



AR-111

		V	W	K		I (cd)	lm	
ACT-FLL-030	G53	12	15	3000K	24°	6000	802	>30000
ACT-FLL-031	G53	12	15	3000K	35°	3000	892	>30000

1 Driver = 1 G53



71-3281-00-00	20-60W	230-240V		20,5 x 36 x 110mm
----------------------	--------	----------	--	-------------------

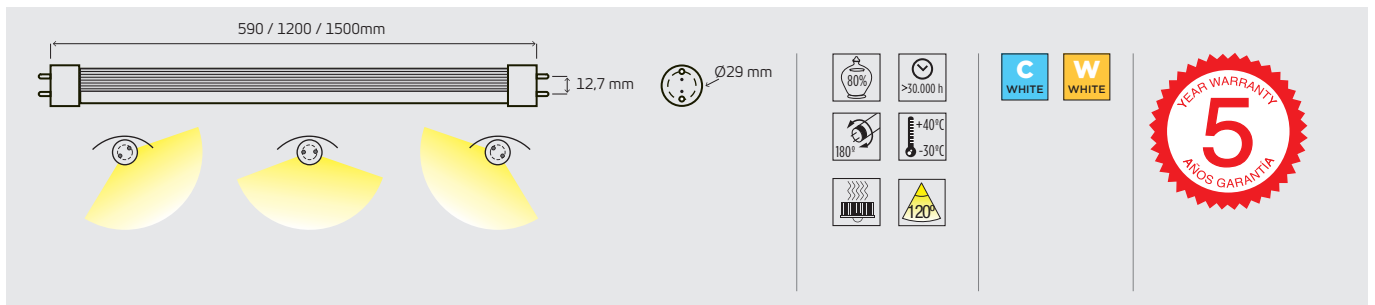

	V	W	L (mm)	K	n° LED	lm		
ACT-FLL-036	G13	100-240 VAC	10	590 mm	5500K	96	748	10
ACT-FLL-037	G13	100-240 VAC	10	590 mm	3000K	96	701	10
ACT-FLL-038	G13	100-240 VAC	18	1200 mm	5500K	192	1513	32
ACT-FLL-039	G13	100-240 VAC	18	1200 mm	3000K	192	1354	32
ACT-FLL-040	G13	100-240 VAC	24	1500 mm	5500K	240	1904	32
ACT-FLL-041	G13	100-240 VAC	24	1500 mm	3000K	240	1735	32



	V	W	L (mm)	K	n° LED	lm		
ACT-FLL-042	G13	100-240 VAC	10	590 mm	5500K	96	898	10
ACT-FLL-043	G13	100-240 VAC	10	590 mm	3000K	96	858	10
ACT-FLL-044	G13	100-240 VAC	18	1200 mm	5500K	192	1862	32
ACT-FLL-045	G13	100-240 VAC	18	1200 mm	3000K	192	1645	32
ACT-FLL-046	G13	100-240 VAC	24	1500 mm	5500K	240	2285	32
ACT-FLL-047	G13	100-240 VAC	24	1500 mm	3000K	240	2042	32



INSTALACIÓN DE TUBO LED / LED TUBE INSTALLATION

INSTALACIÓN EXISTENTE / CURRENT INSTALLATION Tubo fluorescente / Fluorescent tube

Equipo electrónico /
Electric ballast

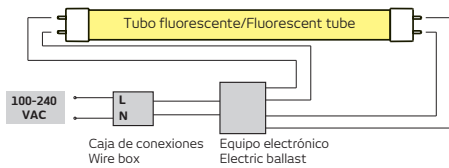

Reactancia magnética /
Inductive ballast

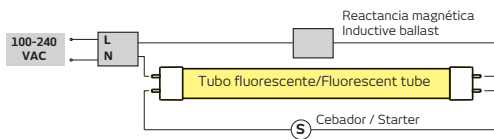

INSTALACIÓN NUEVA / NEW INSTALLATION Tubo led / Led tube

OPCION 1 / OPTION 1
Desconectando el
balastro y retirándolo /
Disconnecting ballast
and removing it

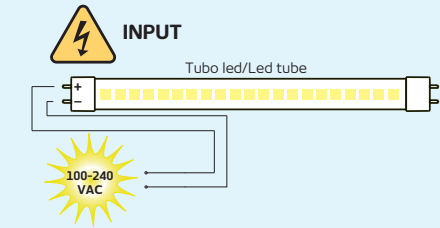

OPCION 2 / OPTION 2
Desconectando el
balastro sin retirarlo /
Disconnecting ballast
but not removing it

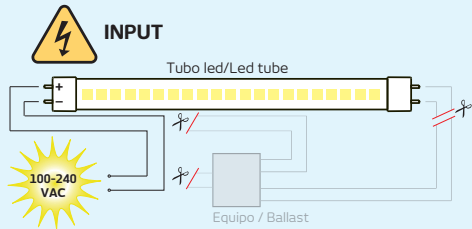

CONSUMO DE POTENCIA REAL / REAL POWER CONSUMPTION

Longitud (mm) Length (mm)	TUBO FLUORESCENTE / FLUORESCENT TUBE			TUBO LED / LED TUBE
	Potencia (W) Power (W)	Reactancia (W) Ballast (W)	Consumo total (W) Total consumption (W)	Consumo total (W) Total consumption (W)
590 mm	18W	1 - 3W	19 - 21W	10W
1200 mm	36W	2 - 5.5W	38.5 - 41.5W	18W
1500 mm	58W	3 - 9W	61 - 67W	24W

ILUMINANCIA REAL / REAL ILLUMINANCE

Valores obtenidos a 2.80m de altura, sin luz ambiental. / Data at 2,80m height, without ambience light.

Modelo Model	Potencia (W) Power (W)	Longitud (mm) Length (mm)	Nº de tubos Nº of tubes	Iluminancia (lx) Illuminance (lx)
Tubo fluorescente OSRAM / OSRAM fluorescent tube	61 - 67W	1500 mm	1	72 lx
Tubo led LEDS-C4 / LEDS-C4 Led tube	24W	1500 mm	1	74 lx



DIFUSOR TRANSPARENTE / TRANSPARENT DIFFUSER

Tubo 590 mm

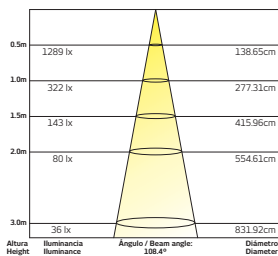

Tubo 1200 mm

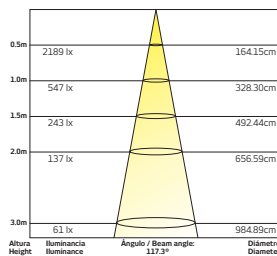

Tubo 1500 mm

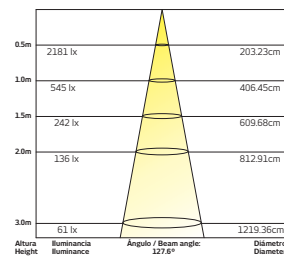

DIFUSOR OPAL / OPAL DIFFUSER

Tubo 590 mm

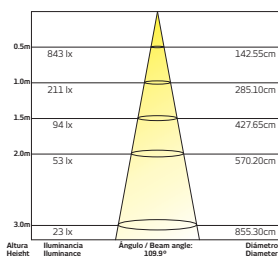

Tubo 1200 mm

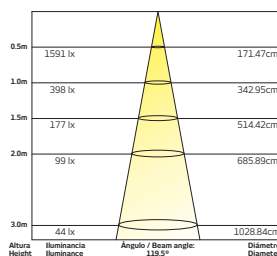

Tubo 1500 mm

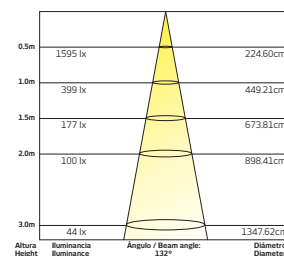



TC-D

TC-DEL

TC-TEL

TC-L

Fluorescente compacta para balastro magnético / Compact fluorescent for magnetic gear / Fluocompacte pour ballast magnétique / Kompaktleuchtstofflampen für magnetisches Vorschaltgerät / Fluorescente compatta per ballast magnetico. / Fluorescente compacta para balastro magnético / Компактная люминесцентная лампа для применения с магнитным балластом / Światłówka kompaktowa dla statecznika magnetycznego

		W	K	V	lm		Ø (mm)	L (mm)			
 TC-D	ACT-FLF-003	G24d-2	18	3.000	230	1.200	8.000	34 x 34	153	10	174 x 81 x 186
	ACT-FLF-004	G24d-2	18	3.000	230	1.200	8.000	34 x 34	153	10	174 x 81 x 186
	ACT-FLF-005	G24d-3	26	4.000	-	1.800	8.000	-	149	10	192 x 81 x 186
	ACT-FLF-006	G24d-3	26	3.000	-	1.800	8.000	-	149	10	192 x 81 x 186

Fluorescente compacta para balastro electrónico / Compact fluorescent for electronic gear / Fluocompacte pour ballast électronique / Kompaktleuchtstofflampen für elektronisches Vorschaltgerät / Fluorescente compatta per ballast elettronico. / Fluorescente compacta para balastro eletrônico / Компактная люминесцентная лампа для применения с электронным балластом / Światłówka kompaktowa dla statecznika elektronicznego

		W	K	V	lm		Ø (mm)	L (mm)			
 TC-DEL	ACT-FLF-009	G24q-2	18	830	230	1.200	10.000	34 x 34	146	10	174 x 81 x 186
	ACT-FLF-010	G24q-2	18	840	230	1.200	10.000	34 x 34	146	10	174 x 81 x 186
	ACT-FLF-011	G24q-3	26	3.000	-	1.800	10.000	-	149	10	192 x 81 x 186
	ACT-FLF-012	G24q-3	26	4.000	-	1.800	10.000	-	149	10	192 x 81 x 186

		W	K	V	lm		Ø (mm)	L (mm)			
 TC-TEL	ACT-FLF-013	GX24q-3	26	830	230	1.800	10.000	49 x 45	131	10	156 x 101 x 256
	ACT-FLF-014	GX24q-3	26	840	230	1.800	10.000	49 x 45	131	10	156 x 101 x 256

Fluorescente compacta no integrada (cfl-ni) / Compact fluorescent non integrated (cfl-ni) / Fluocompacte non intégrée (cfl-ni) / Fluoreszierende Kompaktlampe nicht enthalten / Fluorescente compatta non integrata (cfl-ni) / Lâmpada fluorescente compacta não integrada (cfl-ni) / Компактная люминесцентная лампа без встроенного балласта (cfl-ni) / Światłówka kompaktowa niezintegrowana (cfl-ni)

		W	K	V	lm		Ø (mm)	L (mm)			
 TC-L	ACT-FLF-021	2G11	18	3.000	-	1.200	8.000	17,5	217	10	260 x 103 x 136
	ACT-FLF-022	2G11	24	3.000	-	1.800	8.000	17,5	317	10	365 x 107 x 140
	ACT-FLF-023	2G11	40	3.000	-	3.500	8.000	17,5	533	10	581 x 107 x 140





PL E27



GLOBE E27



INDUCTION



INDUCTION

Fluorescente compacta integrada (CFL-i) / Compact fluorescent integrated (CFL-i) / Fluocompacte intégrée (CFL-i) / Fluoreszierende Kompaktlampe enthalten (CFL-i) / Fluorescente compatta integrata (CFL-i) / Lämpada fluorescente compacta integrada (CFL-i) / Компактная люминесцентная лампа со встроенным балластом (CFL-i) / Świetłówka kompaktowa zintegrowana (CFL-i)

PL
E27

		W	K	V	lm		Ø (mm)	L (mm)		
ACT-FLF-042	E27	11	2.500	220-240	660	20.000	45	117	10	145 x 102 x 242
ACT-FLF-043	E27	14	2.500	220-240	820	20.000	45	131	10	145 x 102 x 242
ACT-FLF-044	E27	22	2.500	220-240	1.440	20.000	58	176	10	194 x 127 x 310

GLOBE
E27

		W	K	V	lm		Ø (mm)	L (mm)		
ACT-FLF-045	E27	18	2.500	220-240	1.060	10.000	120	170	10	179 x 259 x 630

Inducción magnética / Magnetic induction / Induction magnétique / Magnetinduktionslampe / Induzione magnetica / Indução magnética / Лампа, основанная на принципе магнитной индукции / Indukcja magnetyczna



		W	K	V	lm		Ø (mm)	L (mm)		
ACT-FLQ-001	-	300	5.000	110-240	25.500	100.000	421	90	20	850 x 850 x 670
ACT-FLQ-002	-	250	5.000	110-240	21.600	100.000	363	90	20	730 x 730 x 670
ACT-FLQ-003	-	150	5.000	110-240	12.900	100.000	323	80	20	660 x 660 x 610



		W	K	V	lm		Ø (mm)	L (mm)		
ACT-FLQ-006	-	150	5.000	110-240	12.900	100.000	-	390 x 140 x 80	20	845 x 415 x 610
ACT-FLQ-005	-	250	5.000	110-240	21.000	100.000	-	494 x 148 x 90	20	855 x 535 x 660
ACT-FLQ-004	-	300	5.000	110-240	25.000	100.000	-	494 x 152 x 90	20	855 x 585 x 660



E-27 LED

equivalente a
as bright as
60w Incandescent



GX53

Lámparas LED / LED Lamps / Lampes LED / LED-Lampen / Lampade LED / Lâmpadas LED / СД лампы / Lampy LED

		W	K	V		lm		Ø (mm)	L (mm)			
 E-27	ACT-FLL-049	E27	7	4.000	100-240	260°	630	>30.000	60	115	10	340 x 140 x 130
	ACT-FLL-050	E27	7	3.000	100-240	260°	630	>30.000	60	115	10	340 x 140 x 130

		W	K	V		lm		Ø (mm)	L (mm)			
 GX53	ACT-FLL-019	GX53	4	4.000	220-240		250	15.000	75	25	10	660 x 182 x 250

		W	K	V			Ø (mm)	L (mm)	
 QPAR16	ACT-FLL-024	GU10	5	3.000	220-240	24°	-	50	57
	ACT-FLL-025	GU10	5	3.000	220-240	35°	-	50	57
	ACT-FLL-026	GU10	7	3.000	220-240	24°	-	-	-
	ACT-FLL-027	GU10	7	3.000	220-240	35°	-	-	-
	ACT-FLL-028	GU10	7	3.000	220-240	24°		-	-
	ACT-FLL-029	GU10	7	3.000	220-240	35°		-	-

		W	K	V			Ø (mm)	L (mm)	
 MR16	ACT-FLL-020	GU5.3	5	3.000	12	24°	-	50	50
	ACT-FLL-021	GU5.3	5	3.000	12	35°	-	50	50
	ACT-FLL-022	GU5.3	7	3.000	12	24°	-	-	-
	ACT-FLL-023	GU5.3	7	3.000	12	35°	-	-	-

1 Driver = 1 GU5.3



71-3281-00-00	20-60W	230-240V				20,5 x 36 x 110mm
----------------------	--------	----------	--	--	--	-------------------



DATOS FOTOMÉTRICOS / PHOTOMETRIC DATA / DONNÉES PHOTOMÉTRIQUES / FOTOMETRISCHE DATEN / DATI FOTOMETRICI / DADOS FOTOMÉTRICOS / ФОТОМЕТРИЧЕСКИЕ ДАННЫЕ / DANE FOTOMETRYCZNE

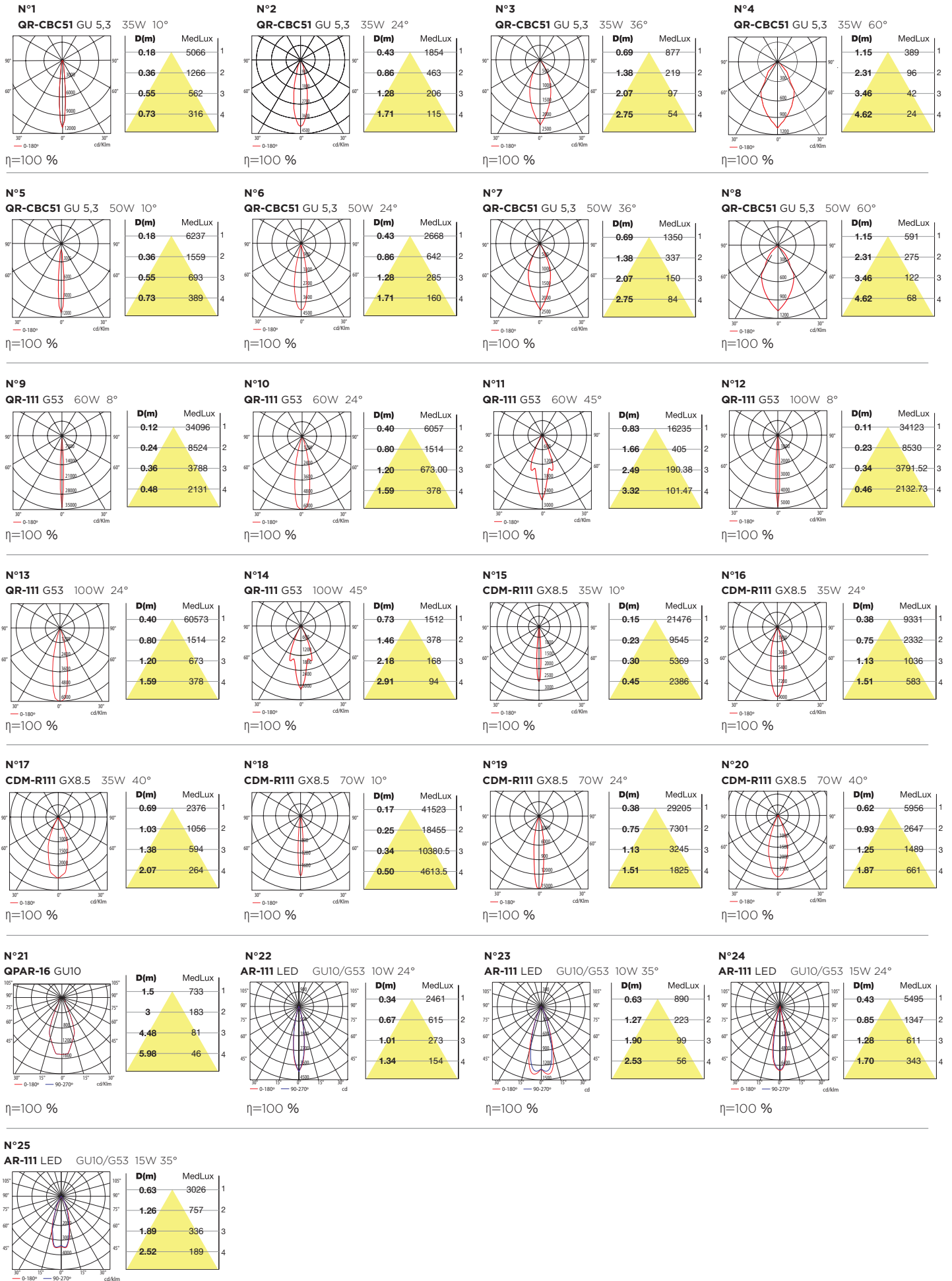







ELECTRICAL UNITS ACCESSORIES

UNIDADES ELÉCTRICAS / ACCESORIOS
PLATINES ÉLECTRIQUES / ACCESSOIRES
NETZTEILE / ZUBEHÖRE
UNITÁ ELETTRICHE / ACCESSORI
UNIDADES ELÉTRICAS / ACESSÓRIOS
ЭЛЕКТРООБОРУДОВАНИЕ / АКЦЕССУАРЫ
CZĘŚCI ELEKTRYCZNE / AKCESORIA

Tabla para la selección de driver. Número máximo de piezas que pueden trabajar con cada equipo.

Driver selection table. Maximum number of pieces that can work with each driver

Tableau de sélection du driver. Nombre maximum de pièces pouvant fonctionner avec chaque appareil

Tabelle für die Auswahl des Treibers. Maximale Anzahl an Teile, die an ein Gerät angeschlossen werden können

Tabella per la selezione del driver. Numero massimo di pezzi che possono funzionare con ciascun dispositivo

Tabela para a seleção de controladores. Número máximo de peças que podem trabalhar com cada equipamento

Таблица для выбора драйвера. Максимальное количество единиц, которые могут работать с каждым устройством

Tablica dla wybrania sterownika. Maksymalna ilość elementów jakie mogą pracować z każdym osprzętem

		ON/OFF																
PRODUCT CODE	CODE	ACT-0803	ACT-0804	ACT-0808	71-4704	71-3477	71-3309	71-3542	71-3305	71-3307	71-3308	71-3478	71-3542	71-4725	71-0744	71-3542	71-0613	71-0612
	INPUT (V)	100-240	100-240	100-240	100-240	100-240	220-240	100-240	100-240	100-240	220-240	100-240	100-240	220-240	220-240	100-240	100-240	100-240
	IP	IP20	IP20	IP20	IP20	IP68	IP20	IP20	IP20	IP20	IP20	IP68	IP20	IP20	IP20	IP20	IP20	IP20
	PAGE	870	870	870	870	870	870	870	870	870	870	870	870	870	870	870	870	870
	CURRENT SERIE	350 mA	350 mA	350 mA	350 mA	350 mA	500 mA	500 mA	700 mA	700 mA	700 mA	700 mA	700 mA	1050 mA	1050 mA	1050 mA	1900 mA	2000 mA
05-1804	SECRET	max3	max4	max11 (8)	max12 (8)	max7												
05-1808	SECRET	max3	max4	max11 (8)	max12 (8)	max7												
05-2900	SIGN	max3	max4	max11 (8)	max12 (8)	max7	max9		max1	max4	max7	max7 (4)	max18 (14)					
05-2904	SECRET	max3	max4	max11 (8)	max12 (8)	max7												
05-3307	BIT	max3	max4	max11 (8)	max12 (8)	max7	max9		max1	max4	max7	max7 (4)	max18 (14)					
05-3308	BIT	max3	max4	max11 (8)	max12 (8)	max7	max9		max1	max4	max7	max7 (4)	max18 (14)					
05-3314	DOT	max3	max4	max11 (8)	max12 (8)	max7	max9		max1	max4	max7	max7 (4)	max18 (14)					
05-3358	MIDI	max1	max1	max3 (2)	max4 (2)	max2	max3	max6		max1	max2	max2 (1)	max6 (4)					
15-4721	FIT														max1			
15-4722	FIT														max1			
15-4723	FIT								max1									
15-4724	FIT								max1									
15-4725	FIT													max1	min2 max3	max3 (2)		
15-4726	FIT													max1	min2 max3	max3 (2)		
55-9257	GEA	max3	max4	max11 (8)	max12 (8)	max7												
55-9621	GEA	max3	max4	max11 (8)	max12 (8)	max7	max9	max20	max1	max4	max7	max7 (4)	max18 (14)					
55-9622	GEA	max3	max4	max11 (8)	max12 (8)	max7	max9	max20	max1	max4	max7	max7 (4)	max18 (14)					
71-3225	PLAY									max1	max2	max2	max6 (5)					
90-0713	EQUAL																	max1
90-0714	EQUAL																max1	
90-0723	EQUAL																	max1
90-0724	EQUAL																max1	
90-0861	EQUAL																	max1
90-0907	EQUAL																	max1
90-0908	EQUAL																max1	
90-0931	EQUAL																max1	

Entre paréntesis (x) valor para 100-127V. Todas las piezas se conectan en serie.

In brackets (x) value for 100-127V. All elements are connected in series.

Entre parenthèses (x) valeur pour 100-127 V. Toutes les pièces sont reliées en série.

In Klammern (x) Wert für 100-127 V. Alle Teile werden in Reihe geschaltet.

Tra parentesi (x) valore per 100-127V. Tutti i pezzi si collegano in successione.

Entre parênteses (x) valor para 100-127 V. Todas as peças se ligam em série.

В скобках (x) величина для 100-127В. Все части соединены последовательно.

W nawiasie (x) wartość dla 100-127V. Wszystkie elementy podłączane są szeregowo.

ON/OFF + DIMMABLE														CODE	PRODUCT CODE	
1-10V PUSH	DALI 1-10V PUSH	1-10V PUSH	1-10V PUSH	DALI 1-10V PUSH	1-10V PUSH	1-10V PUSH	DALI 1-10V PUSH	1-10V PUSH	DALI 1-10V PUSH	1-10V PUSH	DALI 1-10V PUSH	DALI 1-10V PUSH	DALI 1-10V PUSH			CURRENT SERIE
71-3475	71-4706	71-4708	71-3475	71-4706	71-4708	71-3475	71-4706	71-4708	71-4706	71-4708	71-4706	71-4708	71-2413	71-2413		
100-240	100-240	100-240	100-240	100-240	100-240	100-240	100-240	100-240	100-240	100-240	100-240	100-240	100-240	100-240		
IP20	IP20	IP20	IP20	IP20	IP20	IP20	IP20	IP20	IP20	IP20	IP20	IP20	IP20	IP20		
871	871	871	871	871	871	871	871	871	871	871	871	871	871	871		
350 mA	350 mA	350 mA	500 mA	500 mA	500 mA	700 mA	700 mA	700 mA	1050 mA	1050 mA	1050 mA	1050 mA	1750 mA			
max12	max20	max20													SECRET	05-1804
max12	max20	max20													SECRET	05-1808
max12	max20	max20	max12 (8)	max20	max20	max9 (5)	max18	max18							SIGN	05-2900
max12	max20	max20													SECRET	05-2904
max12	max20	max20	max12 (8)	max20	max20	max9 (5)	max18	max18							BIT	05-3307
max12	max20	max20	max12 (8)	max20	max20	max9 (5)	max18	max18							BIT	05-3308
max12	max20	max20	max12 (8)	max20	max20	max9 (5)	max18	max18							DOT	05-3314
max4	max6	max6	max4 (2)	max6	max6	max3 (1)	max6	max6							MIDI	05-3358
										max1	max1	max1(0)			FIT	15-4721
										max1	max1	max1(0)			FIT	15-4722
			max1 (0)	max1	max1										FIT	15-4723
			max1 (0)	max1	max1										FIT	15-4724
										max3	max3	max3(2)			FIT	15-4725
										max3	max3	max3(2)			FIT	15-4726
															GEA	55-9257
max12	max20	max20	max12 (8)	max20	max20	max9 (5)	max18	max18							GEA	55-9621
max12	max20	max20	max12 (8)	max20	max20	max9 (5)	max18	max18							GEA	55-9622
						max3 (2)	max6	max6							PLAY	71-3225
													max2 (1)		EQUAL	90-0713
													max1		EQUAL	90-0714
													max2 (1)		EQUAL	90-0723
													max1		EQUAL	90-0724
													max2 (1)		EQUAL	90-0861
													max2 (1)		EQUAL	90-0907
													max1		EQUAL	90-0908
													max1		EQUAL	90-0931



ON/OFF

		ON/OFF																		
PRODUCT CODE	CODE	ACT-0803	ACT-0804	ACT-0808	71-4704	71-3477	71-3309	71-3542	71-3305	71-3307	71-3308	71-3478	71-3542	71-4725	71-0744	71-3542	71-0613	71-0612		
	INPUT (V)	100-240	100-240	100-240	100-240	100-240	220-240	100-240	100-240	100-240	220-240	100-240	100-240	220-240	220-240	100-240	100-240	100-240		
	IP	IP20	IP20	IP20	IP20	IP68	IP20	IP20	IP20	IP20	IP20	IP68	IP20	IP20	IP20	IP20	IP20	IP20		
	PAGE	870	870	870	870	870	870	870	870	870	870	870	870	870	870	870	870	870	870	
	CURRENT SERIE	350 mA	350 mA	350 mA	350 mA	350 mA	500 mA	500 mA	700 mA	700 mA	700 mA	700 mA	700 mA	1050 mA	1050 mA	1050 mA	1900 mA	2000 mA		
90-1884	DELTA3	max1	max1	max3 (2)	max4 (2)	max2	max3	max6		max1	max2	max2 (1)	max6 (4)							
90-1888	DELTA6			max1	max2 (1)	max1	max1	max3		max1	max1	max3 (2)								
90-1893	DELTA9			max1 (0)	max1 (0)		max1	max2				max2 (1)								
90-1895	DELTA3	max1	max1	max3 (2)	max4 (2)	max2	max3	max6		max1	max2	max2(1)	max6 (4)							
90-1898	DELTA6			max1	max2 (1)	max1	max1	max3		max1	max1	max3 (2)								
90-1902	DELTA9			max1 (0)	max1 (0)		max1	max2				max2 (1)								
90-1914	DELTA3	max1	max1	max3 (2)	max4 (2)	max2	max3	max6		max1	max2	max2 (1)	max6 (4)							
90-1921	DELTA6			max1	max2 (1)	max1	max1	max3		max1	max1	max3 (2)								
90-1922	DELTA9			max1 (0)	max1 (0)		max1	max2				max2 (1)								
90-1923	DELTA3	max1	max1	max3 (2)	max4 (2)	max2	max3	max6		max1	max2	max2 (1)	max6 (4)							
90-1924	DELTA3	max1	max1	max3 (2)	max4(2)	max2	max3	max6		max1	max2	max2 (1)	max6 (4)							
90-1925	DELTA3	max1	max1	max3 (2)	max4 (2)	max2	max3	max6		max1	max2	max2 (1)	max6 (4)							
90-3475	VISION		max1	max2	max3 (2)	max1	max2	max5		max1	max1	max1	max4 (3)							
90-3476	VISION		max1	max2	max3 (2)	max1	max2	max5		max1	max1	max1	max4 (3)							
90-3477	VISION		max1	max2	max3 (2)	max1	max2	max5		max1	max1	max1	max4 (3)							
90-3478	VISION		max1	max2	max3(2)	max1	max2	max5		max1	max1	max1	max4 (3)							
90-3489	OXY	max3	max4	max11 (8)	max12 (8)	max7	max9		max1	max4	max7	max7 (4)	max18 (14)							
90-3490	OXY	max1	max2	max5 (4)	max6 (4)	max3	max4	max10		max2	max3	max3 (2)	max9 (7)							
DN-0289	LEO	max3	max4	max11 (8)	max12 (8)	max7	max9		max1	max4	max7	max7 (4)	max18 (14)							
DN-0290	LEO	max3	max4	max11 (8)	max12 (8)	max7	max9		max1	max4	max7	max7 (4)	max18 (14)							
DN-0472	LEO	max3	max4	max11 (8)	max12 (8)	max7	max9		max1	max4	max7	max7 (4)	max18 (14)							
DN-0511	LEO	max3	max4	max11 (8)	max12 (8)	max7	max9		max1	max4	max7	max7 (4)	max18 (14)							
DN-0512	LEO	max1	max1	max3 (2)	max4 (2)	max2		max6				max6 (4)								
EP-0356	SIGN	max3	max4	max11 (8)	max12 (8)	max7	max9		max1	max4	max7	max7 (4)	max18 (14)							
EP-0360	SIGN	max3	max4	max11 (8)	max12 (8)	max7	max9		max1	max4	max7	max7 (4)	max18 (14)							
EP-1665	SIGN	max3	max4	max11 (8)	max12 (8)	max7	max9		max1	max4	max7	max7 (4)	max18 (14)							

ON/OFF + DIMMABLE

	1-10V PUSH	DALI 1-10V PUSH	1-10V PUSH	1-10V PUSH	DALI 1-10V PUSH	1-10V PUSH	1-10V PUSH	DALI 1-10V PUSH	1-10V PUSH	DALI 1-10V PUSH	1-10V PUSH	DALI 1-10V PUSH	DALI 1-10V PUSH		
	71-3475	71-4706	71-4708	71-3475	71-4706	71-4708	71-3475	71-4706	71-4708	71-4706	71-4708	71-2413	71-2413	CODE	
	100-240	100-240	100-240	100-240	100-240	100-240	100-240	100-240	100-240	100-240	100-240	100-240	100-240	INPUT (V)	
	IP20	IP20	IP20	IP20	IP20	IP20	IP20	IP20	IP20	IP20	IP20	IP20	IP20	IP	
	871	871	871	871	871	871	871	871	871	871	871	871	871	PAGE	
	350 mA	350 mA	350 mA	500 mA	500 mA	500 mA	700 mA	700 mA	700 mA	1050 mA	1050 mA	1050 mA	1750 mA	CURRENT	
														SERIE	PRODUCT CODE
	max4	max6	max6	max4 (2)	max6	max6	max3 (1)	max6	max6					DELTA3	90-3426
	max2	max3	max3	max2 (1)	max3	max3	max1 (0)	max3	max3					DELTA6	90-3427
	max1	max2	max2	max1 (0)	max2	max2	max1 (0)	max2	max2					DELTA9	90-3428
	max4	max6	max6	max4(2)	max6	max6	max3 (1)	max6	max6					DELTA3	90-3481
	max2	max3	max3	max2 (1)	max3	max3	max1 (0)	max3	max3					DELTA6	90-3482
	max1	max2	max2	max1 (0)	max2	max2	max1 (0)	max2	max2					DELTA9	90-3483
	max4	max6	max6	max4 (2)	max6	max6	max3 (1)	max6	max6					DELTA3	90-3486
	max2	max3	max3	max2 (1)	max3	max3	max1 (0)	max3	max3					DELTA6	90-3487
	max1	max2	max2	max1 (0)	max2	max2	max1 (0)	max2	max2					DELTA9	90-3488
	max4	max6	max6	max4 (2)	max6	max6	max3 (1)	max6	max6					DELTA3	90-3425
	max4	max6	max6	max4 (2)	max6	max6	max3 (1)	max6	max6					DELTA3	90-3480
	max4	max6	max6	max4 (2)	max6	max6	max3 (1)	max6	max6					DELTA3	90-3485
	max3	max5	max5	max3 (2)	max5	max5	max2 (1)	max4	max4					VISION	90-3475
	max3	max5	max5	max3 (2)	max5	max5	max2 (1)	max4	max4					VISION	90-3476
	max3	max5	max5	max3 (2)	max5	max5	max2 (1)	max4	max4					VISION	90-3477
	max3	max5	max5	max3 (2)	max5	max5	max2 (1)	max4	max4					VISION	90-3478
	max12	max20	max20	max12 (8)	max20	max20	max9 (5)	max18	max18					OXY	90-3489
	max6	max10	max10	max6 (4)	max10	max10	max4 (2)	max9	max9					OXY	90-3490
	max12	max20	max20	max12 (8)	max20	max20	max9 (5)	max18	max18					LEO	DN-0289
	max12	max20	max20	max12 (8)	max20	max20	max9 (5)	max18	max18					LEO	DN-0290
	max12	max20	max20	max12 (8)	max20	max20	max9 (5)	max18	max18					LEO	DN-0472
	max12	max20	max20	max12 (8)	max20	max20	max9 (5)	max18	max18					LEO	DN-0511
	max4	max6	max6											LEO	DN-0512
	max12	max20	max20	max12 (8)	max20	max20	max9 (5)	max18	max18					SIGN	EP-0356
	max12	max20	max20	max12 (8)	max20	max20	max9 (5)	max18	max18					SIGN	EP-0360
	max12	max20	max20	max12 (8)	max20	max20	max9 (5)	max18	max18					SIGN	EP-1665





Tabla para la selección de fuentes de alimentación y/o controladores
Power supply and controller selection table
Tableau de sélection des sources d'alimentation et des contrôleurs
Tabelle zur Auswahl der Netzgeräte und Controller
Tabella per la selezione delle fonti di alimentazione e controller
Tabela para a selecção de fonte de alimentação e controladores
Таблица для выбора источников питания и контроллеров
Tabela doboru zasilaczy i kontrolerów

								POWER SUPPLY												
								71-0035-00-00	71-0036-00-00	71-0059-00-00	71-0060-00-00	71-3479-00-00	71-0061-00-00	71-0062-00-00	71-0038-00-00	71-0039-00-00				
								VOLTAGE	12	12	12	12	12	12	12	24	24			
								WATTAGE	25	50	72	150	100	240	300	26,4	52,8			
								IP	20	20	20	20	67	20	20	20	20			
								PAGE	872	872	872	872	872	872	872	872	872			
PRODUCT CODE	SERIE	VERSION	VOLT.	W	L(m)	W/M	MAX METERS IN SERIE	MAX METER VS POWER SUPPLY												
91-2343-00-00	RAND HP	CW	12	72	5	14,4	5	1,7mts	3,4mts	5mts	10mts	6,9mts	16mts	10mts						
91-2353-00-00	RAND HP	WW	12	72	5	14,4	5	1,7mts	3,4mts	5mts	10mts	6,9mts	16mts	10mts						
91-3419-00-00	RAND IP	CW	12	24	5	4,8	10	5,2mts	10mts	15mts	31mts	20mts	50mts	62mts						
91-3420-00-00	RAND IP	WW	12	24	5	4,8	10	5,2mts	10mts	15mts	31mts	20mts	50mts	62mts						
91-3473-00-00	SIGMA	WW	12	24	5	4,8	10	5,2mts	10mts	15mts	31mts	20mts	50mts	62mts						
91-0150-00-00	ON ECO	WW	24	24	5	4,8	20								5,5mts	11mts				
91-0171-00-00	ON IP ECO	CW	24	24	5	4,8	20								5,5mts	11mts				
91-0175-00-00	ON IP ECO	WW	24	24	5	4,8	20								5,5mts	11mts				
91-2361-00-00	ON HP	WW	24	72	5	14,4	10								1,8mts	3,6mts				
91-2365-00-00	ON HP	CW	24	72	5	14,4	10								1,8mts	3,6mts				
91-2379-00-00	ON HP	RGB	24	72	5	14,4	5								1,8mts	3,6mts				
91-2488-00-00	ON ECO	RGB	24	36	5	7,2	10								3,6mts	7,3mts				
91-2491-00-00	ON IP ECO	RGB	24	36	5	7,2	10								3,6mts	7,3mts				
91-2492-00-00	ZENIT	White	24	48	5	9,6	10								2,7mts	5,5mts				
91-3227-00-00	FACADE	WW	24	54	15	3,6	15								7,3mts	14mts				
91-3228-00-00	FACADE	RGB	24	87	15	5,8	15								4,5mts	9,1mts				
91-3244-00-00	FACADE	WW	24	54	15	3,6	15								7,3mts	14mts				
91-3245-00-00	FACADE	RGB	24	87	15	5,8	15								4,5mts	9,1mts				
91-3282-00-00	ON HP	WW	24	72	5	14,4	10								1,8mts	3,6mts				
91-4671-00-00	ON	WW	24	24	5	4,8	20								5,5mts	11mts				

CONTROLLERS																		
						WHITE						RGB						
71-0063-00-00	71-0064-00-00	71-4727-00-00	71-0065-00-00	71-0066-00-00	71-0017-00-00	71-0727-00-00	71-3473-00-00	71-1553-00-00	71-3467-00-00	71-3468-00-00	71-0019-00-00	71-4662-00-00	71-4663-00-00	71-3493-00-00	71-1553-00-00	71-4664-00-00	71-4665-00-00	
						Controller with remote control	1-IOV Controller	DALI Controller	Amplifier	Zenit controller with remote control	Zenit Amplifier	Controller with remote control	Controller (remote control optional)	Controller (remote control optional)	DMX Controller	Amplifier	Facade controller with remote control	Facade Amplifier
24	24	24	24	24	12(144W)	12(156W)	12(60W)	12(48W)	12(120W)	12(120W)	12(216W)	12(216W)	12(216W)	12(72W)	12(144W)			
76,8	156	150	240	312	24(288W)	24(312W)	24(120W)	24(96W)	24(240W)	24(240W)	24(432W)	24(432W)	24(432W)	24(144W)	24(288W)	24(210W)	24(360W)	
20	20	67	20	20	IP20	IP20	IP20	IP20	IP20	IP20	IP20	IP20	IP65	IP20	IP20	IP20	IP20	
872	872	872	872	872	879	879	879	879	213	213	876	876	876	877	879	221	221	
MAX METER VS POWER SUPPLY						MAX METER VS CONTROLLER												
						10mts	10mts	4,1mts	3,3mts									
						10mts	10mts	4,1mts	3,3mts									
						20mts	20mts	12mts	20mts									
						20mts	20mts	12mts	20mts									
						20mts	20mts	12mts	20mts									
16mts	32mts	31mts	50mts	65mts	60mts	65mts	25mts	20mts										
16mts	32mts	31mts	50mts	65mts	60mts	65mts	25mts	20mts										
16mts	32mts	31mts	50mts	65mts	60mts	65mts	25mts	20mts										
5,3mts	10mts	10mts	16mts	21mts	20mts	21mts	8,3mts	6,6mts										
5,3mts	10mts	10mts	16mts	21mts	20mts	21mts	8,3mts	6,6mts										
5,3mts	10mts	10mts	16mts	21mts							30mts	30mts	30mts	10mts	20mts			
10mts	21mts	20mts	33mts	43mts							60mts	60mts	60mts	20mts	40mts			
10mts	21mts	20mts	33mts	43mts							60mts	60mts	60mts	20mts	40mts			
8mts	16mts	15mts	25mts	32mts					25mts	25mts								
21mts	43mts	41mts	66mts	86mts	80mts	86mts	33mts	26mts										
13mts	26mts	25mts	41mts	53mts												36mts	62mts	
21mts	43mts	41mts	66mts	86mts	80mts	86mts	33mts	26mts										
13mts	26mts	25mts	41mts	53mts												36mts	62mts	
5,3mts	10mts	10mts	16mts	21mts	20mts	21mts	8,3mts	6,6mts										
16mts	32mts	31mts	50mts	65mts	60mts	65mts	25mts	20mts										



POWER SUPPLY

CODE	71-0035-00-00	71-0036-00-00	71-0059-00-00	71-0060-00-00	71-3479-00-00	71-0061-00-00	71-0062-00-00	71-0038-00-00	71-0039-00-00
									
VOLTAGE	12	12	12	12	12	12	12	24	
WATTAGE	25	50	72	150	100	240	300	26,4	52,8
IP	20	20	20	20	67	20	20	20	20
PAGE	872	872	872	872	872	872	872	872	872

PRODUCT CODE	SERIE	VERSION	VOLT.	W	L(m)	MAX PCS IN SERIES	MAX PCS VS POWER SUPPLY										
05-1544-54-H6	TRON	RGB	24	30	0,5	4											max1
05-1546-54-H6	TRON	NW	24	24	0,5	4										max1	max2
05-1547-54-H6	TRON	WW	24	24	0,5	4										max1	max2
05-1548-54-H6	TRON	RGB	24	60	1	2											
05-1549-54-H6	TRON	NW	24	48	1	2											max1
05-1552-54-H6	TRON	WW	24	48	1	2											max1
05-2494-54-H6	RAY	NW	24	48	0,378	2											max1
05-2498-54-H6	RAY	RGB	24	60	0,378	2											
05-2499-54-H6	RAY	WW	24	48	0,378	2											max1
91-3408-54-M2	ION	WW	12	14,4	1	3	max1	max3	max5	max10	max6	max16	max20				
91-3411-54-M2	ION	WW	12	7,2	0,5	6	max3	max6	max10	max20	max13	max33	max41				

CONTROLLERS																			
					WHITE							RGB							
71-0063-00-00	71-0064-00-00	71-4727-00-00	71-0065-00-00	71-0066-00-00	71-0017-00-00	71-0727-00-00	71-3473-00-00	71-1553-00-00	71-3467-00-00	71-3468-00-00	71-0019-00-00	71-4662-00-00	71-4663-00-00	71-3493-00-00	71-1553-00-00	71-4664-00-00	71-4665-00-00		
					Controller with remote control	1-10V Controller	DALI Controller	Amplifier	Zenit controller with remote control	Zenit Amplifier	Controller with remote control	Controller (remote control optional)	Controller (remote control optional)	DMX Controller	Amplifier	Facade controller with remote control	Facade Amplifier		
24	24	24	24	24	12(144W)	12(156W)	12(60W)	12(48W)	12(120W)	12(120W)	12(216W)	12(216W)	12(216W)	12(72W)	12(144W)				
76,8	156	150	240	312	24(288W)	24(312W)	24(120W)	24(96W)	24(240W)	24(240W)	24(432W)	24(432W)	24(432W)	24(144W)	24(288W)	24(210W)	24(360W)		
20	20	67	20	20	IP20	IP20	IP20	IP20	IP20	IP20	IP20	IP20	IP65	IP20	IP20	IP20	IP20		
872	872	872	872	872	879	879	879	879	213	213	876	876	876	871	879	221	221		
MAX PCS VS POWER SUPPLY					MAX PCS VS CONTROLLER														
max2	max5	max3	max8	max10							max14	max14	max14	max4	max9				
max3	max6	max6	max10	max13	max12	max13	max5	max4											
max3	max6	max6	max10	max13	max12	max13	max5	max4											
max1	max2	max2	max4	max5							max7	max7	max7	max2	max4				
max1	max3	max3	max5	max6	max6	max6	max2	max2											
max1	max3	max3	max5	max6	max6	max6	max2	max2											
max1	max3	max3	max5	max6	max6	max6	max2	max2											
max1	max2	max2	max4	max5							max7	max7	max7	max2	max4				
max1	max3	max3	max5	max6	max6	max6	max2	max2											
					max6	max6	max4	max3											
					max12	max12	max8	max6											



ON-OFF / ВКЛ/ВЫКЛ / WŁĄCZ/WYŁĄCZ



ACT-0803-00-00



21,5 x 35 x 68 mm



ACT-0804-00-00



21,5 x 35 x 78 mm



ACT-0808-00-00



19 x 34 x 115 mm



71-4704-00-00



28 x 38 x 125 mm



71-3477-00-00



97 x 97 x 72 mm

500mA



71-3309-00-00



28 x 37 x 128 mm

700mA



71-3305-00-00



20 x 39 x 55 mm



71-3307-00-00



19 x 34 x 115 mm



71-3308-00-00



28 x 38 x 127 mm



71-3478-00-00



97 x 97 x 72 mm

XXXmA



71-0744-00-00



35 x 54 x 128 mm

1 A



71-4725-00-00



28 x 38 x 125 mm

1,05 A



71-0613-00-00



35 x 61,5 x 181 mm

1,9 A



71-0612-00-00



30 x 47 x 145 mm

2 A



71-3542-00-00



22 x 79 x 124,5 mm

Regulable / Dimmable / Régulable / Dimmbar / Regolabile / Regulável / Регулируемый / Ściemniany



71-3475-00-00



22 x 67 x 103 mm



71-4706-00-00



21 x 79 x 123,5 mm



71-2413-00-00



35 x 83 x 163 mm



71-4708-00-00



21 x 79 x 123,5 mm

CABLE PARA SINCRONIZACIÓN, SERVIDO SEPARADAMENTE
 CABLE FOR SYNCHRONISING SLAVE REGULATORS
 CÂBLE DE SYNCHRONISATION FOURNI SÉPARÉMENT
 KABEL FÜR DIE SYNCHRONISIERUNG VON SLAVE-REGLERN
 CAVO PER SINCRONIZZAZIONE, FORNITO SEPARATAMENTE
 CABO PARA SINCRONIZAÇÃO, FORNECIDO EM SEPARADO
 СИНХРОНИЗИРУЮЩИЙ КАБЕЛЬ, ПОСТАВЛЯЕТСЯ ОТДЕЛЬНО
 PRZEWÓD DLA SYNCHRONIZOWANIA, DOSTARCZANY ODDZIELNIE

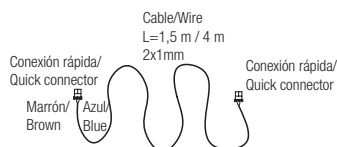

71-3476-00-00 1,5m cable

71-4707-00-00 4m cable



12
VDC

Fuentes de alimentación / Power supply / Sources d'alimentation / Netzgeräte / Fonti di alimentazione / Fontes de alimentação / Источники питания / Zasilacze

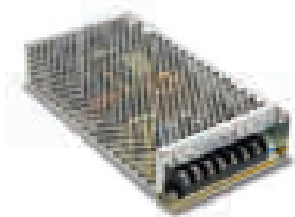

71-0035-00-00	100-240V	2,1 A	25W				28 x 51 x 92 mm
71-0036-00-00	100-240V	4,2 A	50W	⊕	IP 20	-	36 x 97 x 99 mm
71-0059-00-00	100-240V	6 A	72W				38 x 98 x 129 mm
71-0060-00-00	100-120V; 200-240V	12,5 A	150W				38 x 98 x 199 mm



71-0061-00-00	100-240V	12 A	240W	⊕	IP 20		50 x 93 x 204 mm
71-0062-00-00	100-240V	25 A	300W				50 x 115 x 229 mm



71-3479-00-00	110-264V	8,3 A	100W	□	IP 67	-	34 x 60 x 240 mm
----------------------	----------	----------	------	---	----------	---	------------------



71-9198-05-05	230V	1,6 A	20W	□	IP 68	1m	-	149 x 115 x 115 mm
----------------------	------	----------	-----	---	----------	----	---	--------------------

24
VDC

Fuentes de alimentación / Power supply / Sources d'alimentation / Netzgeräte / Fonti di alimentazione / Fontes de alimentação / Источники питания / Zasilacze



71-0038-00-00	100-240VAC	1,1 A	26,4W	⊕	IP 20	-	28 x 51 x 92 mm
71-0039-00-00	100-240VAC	2,2 A	52,8W				36 x 97 x 99 mm
71-0063-00-00	100-240VAC	3,2 A	76,8W				38 x 98 x 129 mm
71-0064-00-00	100-120VAC; 200-240VAC	6,5 A	156W				38 x 98 x 199 mm



71-0065-00-00	100-240VAC	10 A	240W	⊕	IP 20		50 x 93 x 204 mm
71-0066-00-00	100-240VAC	13 A	312W				50 x 115 x 229 mm

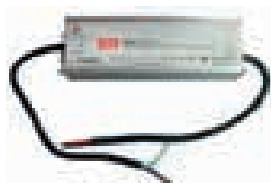

71-4727-00-00	90-264VAC	6,3 A	150W	⊕	IP 67	-	38,8 x 68 x 228 mm
----------------------	-----------	----------	------	---	----------	---	--------------------

12
VAC

Transformador / Transformer / Transformateur / Transformator / Trasformatore /
Transformador / трансформатор / Transformator

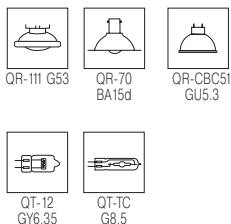

ACT-TRA-001	20-60W	IP 20	37 x 28 x 1 28 mm
ACT-TRA-002	20-70W		37 x 28 x 128 mm
71-2477-00-00	20-105W	E	35 x 21 x 107 mm
ACT-TRA-003	35-105W		50 x 19,5 x 146 mm
ACT-TRA-004	50-150W	Dimming	37 x 33 x 185 mm



71-9197-05-05	0- 100W	IP 68	1m	M	149 x 115 x 115 mm
----------------------	---------	-------	----	---	--------------------

Equipo para lámparas de descarga / Equipment for discharge lamps / Appareillages pour lampes à décharge / Vorschaltgeräte für Gasentladungslampen / Apparecchiature per lampade a scarica / Equipamentos para lâmpadas de descarga / Наборы для газоразрядных ламп / Osprzet dla lamp wyładowczych.

100-240V
50-60Hz

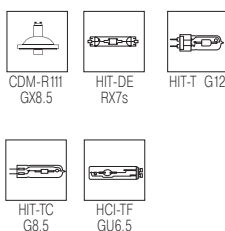

ACT-BAL-008	20W	43 x 30 x 190 mm
ACT-BAL-003	35W	67 x 31 x 140 mm
ACT-BAL-004	2x35W	89 x 37 x 224 mm
ACT-BAL-005	70W	83 x 32 x 170 mm
ACT-BAL-006	2x70W	89 x 37 x 224 mm
ACT-BAL-007	150W	89 x 37 x 186 mm

230V 50Hz

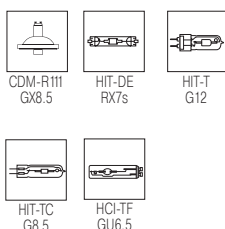

ACT-BAL-009	35W	73 x 61 x 222 mm
ACT-BAL-010	70W	73 x 61 x 222 mm
ACT-BAL-011	150W	73 x 61 x 250 mm



CONTROLADORES DMX / DMX CONTROLLERS / CONTRÔLEURS DMX / DMX-CONTROLLER / REGOLATORI DMX / CONTROLADORES DMX / КОНТРОЛЛЕРЫ DMX / STEROWNIK DMX

- Para configuraciones a medida, consulte con nuestro Equipo Comercial
- For bespoke combinations please contact our Sales department
- Pour des configurations sur mesure, merci de consulter notre Équipe Commerciale
- Für Konfigurationen nach Maß, sprechen Sie uns bitte an
- Per configurazioni su misura rivolgersi al ns. ufficio commerciale.

- Para configurações à medida, consulte a n/ Equipa Comercial
- Для модификаций по индивидуальным параметрам свяжитесь с нашими коммерческими сотрудниками.
- Dla wspomnianych zestawień prosimy o kontakt z naszym działem sprzedaży

71-2469-00-00

86 x 86 x 10 mm

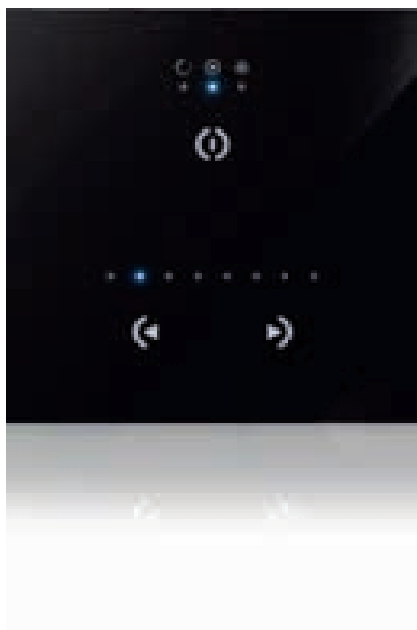

- Controladores DMX512 que no requiere de sistema operativo para ejecutarse.
- Ajuste en tiempo real de la intensidad y el color de una escena.
- Programmable mediante el software de control y el cable USB incluidos.
- Fuente de alimentación incluida.
- DMX512 Stand Alone Controller.
- Live setting of the intensity and colour of a scene.
- Programmable with the included USB cable and control software.
- Power supply included.
- Contrôleurs DMX512 dont l'exécution n'exige pas de système d'exploitation.
- Réglage en temps réel de l'intensité et de la couleur d'une scène.
- Programmable à l'aide du logiciel de commande et du câble USB fournis.
- Source d'alimentation fournie.
- DMX512-Controller, die kein Betriebssystem erfordern.
- Einstellung der Lichtsärke und Farbe in Echtzeit.
- Programmierbar mittels Steuersoftware, USB-Kabel mitgeliefert.
- Netzteil mitgeliefert.

- Regolatori DMX512 che non necessitano di sistema operativo per funzionare.
- Regolazione in tempo reale dell'intensità e del colore di una scena.
- Programmabile tramite il software di controllo e il cavo USB inclusi.
- Fonte di alimentazione inclusa.
- Controladores DMX512 que não necessitam de sistema operativo para funcionar.
- Ajuste em tempo real da intensidade e da cor de uma cena.
- Programável através do software de controlo e do cabo USB incluídos.
- Fonte de alimentação incluída.
- Контроллеры DMX512, не требующие для работы оперативной системы.
- Регулировка в реальном времени интенсивности и цвета сцены.
- Программируемые с помощью входящих в комплект контрольной программы и кабеля USB.
- В комплект входит источник питания.
- Sterownik DMX512, który nie wymaga systemu operacyjnego dla jego obsługi.
- Ustawienie w czasie rzeczywistym natężenia i koloru sceny.
- Programowany za pomocą załączonego oprogramowania sterującego i przewodu USB.
- Zawarte źródło zasilania.

71-2471-00-00

130 x 170 x 11 mm



- Controlador DMX de instalación en pared, que no requiere de sistema operativo para ejecutarse.
- Panel táctil con 25 páginas de 8 escenas.
- Cable USB, CDROM para instalación y manual de usuario incluidos.
- Fuente de alimentación y control remoto Infrarrojo incluidos.
- Stand alone wall mounted DMX controller.
- Touch-sensitive panel with 25 pages of 8 scenes.
- Delivered with a USB cable and installation CDROM including user manual.
- Power supply and Infra red remote control included.
- Contrôleur DMX à installation murale, dont l'exécution n'exige pas de système d'exploitation.
- Tableau tactile avec 25 pages de 8 scènes.
- Câble USB, CD-ROM d'installation et manuel de l'utilisateur fournis.
- Source d'alimentation et télécommande Infrarouge fournies.
- DMX-Controller zum Wandeinbau, kein Betriebssystem erforderlich.
- Touchscreen mit 25 Seiten à 8 Szenen.
- USB-Kabel, CDROM zur Installation und Bedienungsanleitung mitgeliefert.
- Netzteil und Infrarot-Fernbedienung mitgeliefert.

- Regolatore DMX da installare parete, che non necessita di un sistema operativo per funzionare.
- Pannello tattile con 25 pagine di 8 scene.
- Cavo USB, CDROM per l'installazione e manuale per l'utente inclusi.
- Fonte di alimentazione e controllo remoto Infrarossi inclusi.
- Controlador DMX de instalação em parede, que não necessita de sistema operativo para funcionar.
- Painel tátil com 25 páginas de 8 cenas.
- Cabo USB, CD-ROM para instalação e manual de utilizador incluídos.
- Fonte de alimentação e controlo remoto por infravermelhos incluídos.
- Настенный контроллер DMX, не требующий оперативной системы.
- Сенсорная панель с 25 страницами из 8 сцен.
- В комплект включены USB-кабель, CD-ROM для установки и руководство пользователя.
- Источник питания и инфракрасный дистанционный пульт управления включены в комплект.
- Sterownik DMX instalacji na ścianie, który nie wymaga systemu operacyjnego dla jego obsługi.
- Panel dotykowy o 25 stronach 8 scen.
- Zawarte: przewód USB, CDROM dla zainstalowania i instrukcja użytkownika.
- Zawarte źródło zasilania i zdalne sterowanie na podczerwień.

71-2472-00-00

90 x 80 x 42 mm



- Interfaz Mini USB-DMX interface.
- Memoria de 64K con reloj/calendario.
- Cable USB, CDROM para instalación y manual de usuario incluidos.
- Fuente de alimentación incluida.

- Mini USB-DMX interface.
- 64K memory with clock/calendar.
- Delivered with a USB cable and installation CDROM including user manual.
- Power supply included.

- Interface Mini USB-DMX.
- Mémoire de 64 K avec horloge/calendrier.
- Câble USB, CD-ROM d'installation et manuel de l'utilisateur fournis.
- Source d'alimentation fournie.

- Schnittstelle Mini USB-DMX
- 64-K-Speicher mit Uhr/Kalender
- USB-Kabel, CDROM zur Installation und Bedienungsanleitung mitgeliefert.
- Netzteil mitgeliefert.

- Interfaccia Mini USB-DMX.
- Memoria di 64K con orologio/calendario.
- Cavo USB, CDROM per l'installazione e manuale per l'utente inclusi.
- Fonte di alimentazione inclusa.

- Interface Mini USB-DMX.
- Memória de 64 K com relógio/calendário.
- Cabo USB, CD-ROM para instalação e manual de utilizador incluídos.
- Fonte de alimentação incluída.

- Интерфейс мини USB-DMX.
- Память 64К с часами/календарем.
- В комплект включены USB-кабель, CD-ROM для установки и руководство пользователя.
- В комплект входит источник питания.

- Interfejs Mini USB-DMX.
- Pamięć 64K z zegarem/kalendarzem.
- Zawarte: przewód USB, CDROM dla zainstalowania i instrukcja użytkownika.
- Zawarte źródło zasilania.



CENTRO CULTURAL DE LAS TELECOMUNICACIONES. SANTO DOMINGO, REP. DOMINICANA.



Controladores RGB con mando a distancia / RGB controllers with remote control / Contrôleurs RGB avec télécommande / RGB-Controller mit Fernbedienung / Regolatori RGB con telecomando / Controladores RGB com comando à distância / Контроллеры RGB с пультом дистанционного управления / Kontrolery RGB z pilotem zdalnego sterowania



71-0019-00-00

12 VDC	216W	24 x 84 x 65 mm
24 VDC	432W	

•Controlador de tiras led con 15 programas RGB predefinidos, anillo de control independiente de 64 colores, cambio de velocidad en programas con secuencia de colores y cambio de intensidad luminica en programas monocolor. Incorpora un mando a distancia por radiofrecuencia.
 •LED stripe controller with 15 pre-set RGB programmes, 64-colour independent control ring, change of speed for programmes with colour sequence and change of light intensity for monochrome programmes. It incorporates a radio-frequency remote control.
 •Contrôleleur de bandeaux à LED offrant 15 niveaux RGB prédéfinis, un anneau de contrôle indépendant à 64 couleurs, un changement de vitesse pour les programmes à séquence de couleurs, ainsi qu'un changement d'intensité pour les programmes monocolors. Muni d'une télécommande par radiofréquence.
 •Reglung von LED-Streifen mit 15 vordefinierten RGB-Programmen, unabhängiger Ring zur Regulierung von 64 Farben, Änderung der Geschwindigkeit bei Programmen mit Farbabfolgen und Änderung der Lichtintensität bei einfarbigen Programmen. Mit Fernbedienung über Funk.

•Regolatori di strisce led con 15 programmi RGB predefiniti, anello di controllo indipendente di 64 colori, cambio di velocità nei programmi con sequenza di colori e cambio di intensità luminosa nei programmi monocolor. Contiene un telecomando a radiofrequenza.
 •Controlador de fitas LED con 15 programas RGB predefinidos, anel de control independente de 64 cores, mudança de velocidade em programas com sequência de cores e mudança de intensidade luminosa em programas monocolor. Incorpora um comando à distância por radiofrequência.
 •Контроллер для светодиодных линеек RGB с 15 стандартными программами, кольцом независимого контроля для 64 цветов, смена скорости для многоцветных программ и изменения яркости для одноцветных программ. Включен пульт дистанционного радиуправления.
 •Kontroler taśm LED z 15 wcześniej określonymi programami RGB, obręcz niezależnego sterowania 64 kolorów, zmiana szybkości w programach z sekwencjami kolorów oraz zmiana natężenia oświetlenia w jednobarwnych programach. Zawiera pilot zdalnego sterowania z częstotliwością radiową.

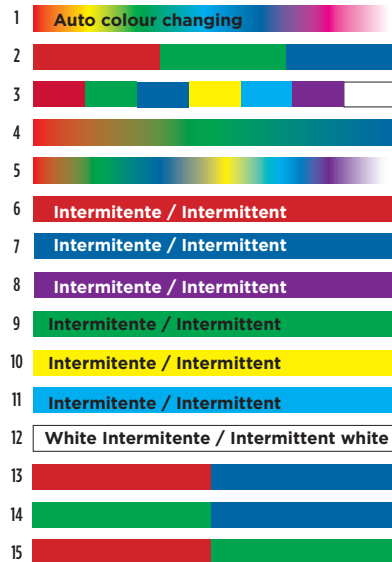

Controladores RGB con o sin mando a distancia / RGB controllers with or without remote control / Contrôleurs RGB avec ou sans télécommande / RGB-Controller mit oder ohne Fernbedienung / Regolatori RGB con o senza telecomando / Controladores RGB com ou sem comando à distância / Контроллеры RGB с пультом дистанционного управления или без такового / Kontrolery RGB z lub bez pilota zdalnego sterowania



71-4662-00-00

12 VDC	216W	29 x 45 x 226 mm
24 VDC	432W	

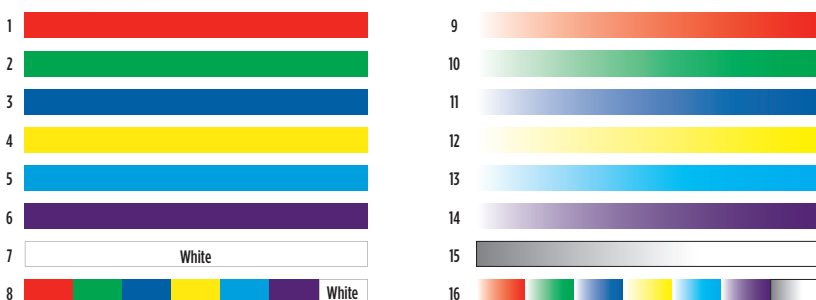

71-4663-00-00

12 VDC	216W	46,5 x 55,5 x 191 mm
24 VDC	432W	

Mando a distancia para / Remote control for / Télécommande pour / Fernbedienung für / Telecomando per / Comando à distância para / Пульт дистанционного управления для / Pilot zdalnego sterowania dla 71-4662, 71-4663

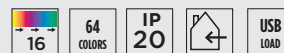

- Mando a distancia con señal de radiofrecuencia que permite gestionar los controladores RGB 71-4662-00-00 y 71-4663-00-00.
- Radio frequency remote control for managing the RGB 71-4662-00-00 and 71-4663-00-00 controllers.
- Télécommande à signal de radiofréquence qui permet de gérer les contrôleurs RGB 71-4662-00-00 et 71-4663-00-00.
- Fernbedienung mit Radiofrequenzsignal zur Steuerung der RGB-Controller 71-4662-00-00 und 71-4663-00-00.

- Telecomando a radiofrecuencia che consente di gestire i regolatori RGB 71-4662-00-00 e 71-4663-00-00.
- Comando à distância com sinal de radiofrequência que permite gerir os controladores RGB 71-4662-00-00 e 71-4663-00-00.
- Пульт дистанционного радиоуправления для контроля RGB 71-4662-00-00 и 71-4663-00-00.
- Pilot zdalnego sterowania na sygnał częstotliwości radiowej, który pozwala na zarządzanie kontrolerami RGB 71-4662-00-00 i 71-4663-00-00.



71-4666-00-00

17 x 58 x 147,5 mm

Equipos de control / Device controllers / Contrôleur gradation / Controller / Dispositivi di controllo / Equipamentos de controlo / Контрольные устройства / Osprzęt sterujący



71-3493-00-00

12 VDC	24W	X	4
24 VDC	48W		

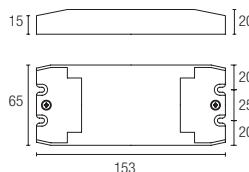

EASY RGB



71-9630-34-34



Controlador MASTER RGB 100-240V hasta 60W. / MASTER RGB controller 100-240V up to 60W. / Contrôleur MASTER RGB 100-240 V à 60 W. / Steuerung MASTER RGB 100-240V bis 60W. / Regolatore MASTER RGB 100-240V fino a 60W. / Controlador PRINCIPAL RGB 100-240 V até 60 W. / Контроллер MASTER RGB 100-240В до 60 Вт. / Kontroler MASTER RGB 100-240V do 60W.

275 x 63 x 80 mm



71-9632-34-34



Controlador ESCLAVO RGB 100-240V hasta 60W. / SLAVE RGB controller 100-240V up to 60W. / Contrôleur ESCLAVE RGB 100-240 V jusqu'à 60 W. / Steuerung SLAVE RGB 100-240V bis 60W. / Regolatore SLAVE RGB 100-240V fino a 60W. / Controlador SECUNDÁRIO RGB 100-240 V até 60 W. / Контроллер ESCLAVO RGB 100-240В до 60 Вт. / Kontroler ESCLAVO RGB 100-240V do 60W.

265 x 63 x 80 mm



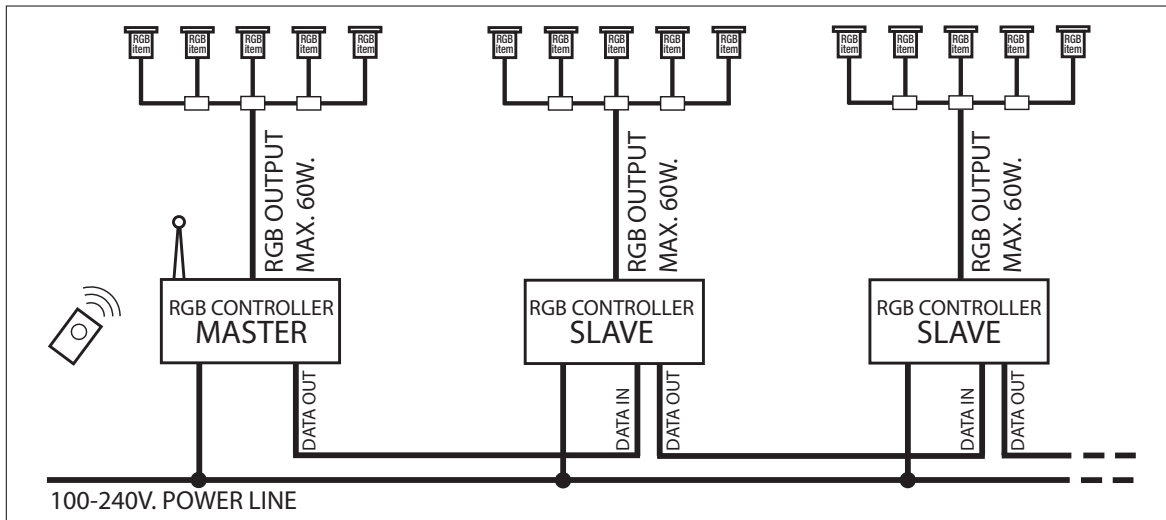

¿POR QUÉ LO LLAMAMOS EASY RGB?
 WHY DO WE CALL IT EASY RGB?
 POURQUOI L'APPELLATION EASY RGB ?
 WARUM HEISST ES EASY RGB?

PERCHÉ LO CHIAMIAMO EASY RGB?
 PORQUÊ O NOME EASY RGB?
 ПОЧЕМУ МЫ НАЗЫВАЕМ ЕГО EASY RGB?
 DLACZEGO TO NAZYWAMY EASY RGB?



- Toda la instalación se hace mediante cables estándar de 3 polos.
- The entire installation is carried out using standard 3-core cables.
- Toute l'installation s'effectue à l'aide de câbles standard à 3 pôles.
- Die Installation erfolgt mittels 3-poligen Standardkabeln.
- L'intera installazione viene eseguita tramite cavi standard di 3 poli.
- Toda a instalação se faz através de cabos standard de 3 polos.
- Вся установка осуществляется с помощью стандартного 3-х фазного кабеля.
- Całą instalację wykonuje się za pomocą standardowych przewodów 3 biegunowych.



- Toda la instalación se realiza con conectores estándar.
- The entire installation is carried out using standard connectors.
- Toute l'installation s'effectue à l'aide de connecteurs standard.
- Die Installation erfolgt mit Standardsteckern.
- L'intera installazione viene eseguita con connettori standard.
- Toda a instalação se realiza com conectores standard.
- Все работы по установке выполняются со стандартными соединителями.
- Całą instalację wykonuje się za pomocą standardowych łączników.



- Podemos usar el pulsador situado en el lateral de la caja del controlador para cambiar el programa en caso de pérdida o falta de batería del mando a distancia.
- We can use the push-button located on the side of the controller box to change the programme in the event of loss or lack of battery power in the remote control.
- On peut utiliser le bouton situé sur le côté du boîtier du contrôleur pour changer de programme en cas de perte ou d'absence de batterie de la télécommande.
- Die Taste kann seitlich an dem Controllergehäuse sitzen, um auch bei Verlust der Fernbedienung oder leerer Batterie der Fernbedienung umschalten zu können.
- Possiamo utilizzare il pulsante che si trova sul lato della scatola del regolatore per cambiare il programma in caso di perdita o mancanza di batteria del telecomando.
- Podemos usar o botão situado na lateral da caixa do controlador para mudar o programa, se não soubermos onde está o comando à distância ou este tiver a bateria descarregada.
- Мы можем использовать кнопку на боковой стороне корпуса контроллера, чтобы вносить изменения в программу в случае потери или отсутствия батареи пульты ДУ.
- Możemy użyć przycisku położonego z boku skrzynki kontrolera w celu zmienienia programu w przypadku utraty lub braku baterii pilota zdalnego sterowania.

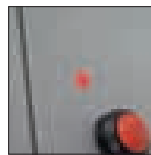

- Un pequeño LED rojo situado en el lateral de la caja del controlador nos indica que hay un cruce en alguna parte de la instalación.
- A small red LED located on the side of the controller box indicates that there is interference somewhere in the installation.
- Un petit voyant LED rouge situé sur le côté du boîtier du contrôleur indique la présence d'un croisement dans l'installation.
- Eine kleine rote LED an der Seite des Controllergehäuses zeigt an, wenn an einer Stelle der Installation eine Leitungskreuzung besteht.
- Un piccolo LED rosso che si trova nel lato della scatola del regolatore ci indica che c'è un incrocio in qualche parte dell'installazione.
- Um pequeno LED vermelho situado na lateral da caixa do controlador indica-nos que há uma interferência nalguma parte da instalação.
- Небольшой красный светодиод на боковой стороне коробки контроллера указывает на то, что где-то в установке существует пересечение.
- Mała czerwona LED położona z boku skrzynki kontrolera wskazuje nam, że doszło do zwarcia się w jakiejś części instalacji.

EASY RGB

POSICIONES DEL PROGRAMA. / PROGRAMME POSITIONS. / POSITIONS DU PROGRAMME / PROGRAMMPOSITIONEN
 POSIZIONI DEL PROGRAMMA. / POSIÇÕES DO PROGRAMA. / ПОЗИЦИИ ПРОГРАММЫ. / POŁOŻENIA PROGRAMU.

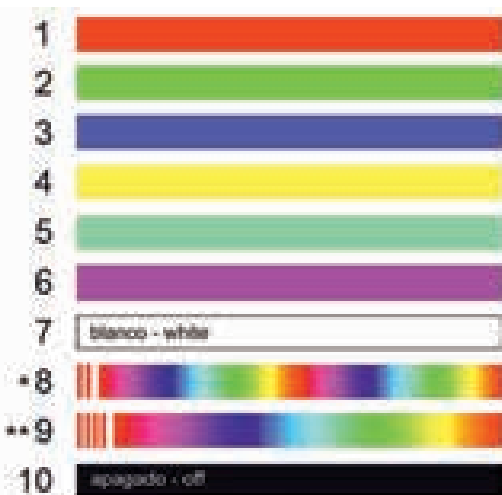

- ★ 2 flash, cambia todos los colores uno a uno durante 90 segundos y vuelve a empezar.
 2 flash, changes all colours one by one for 90 seconds and then starts again.
 2 flashes : change toutes les couleurs une à une pendant 90 secondes et recommence.
 2 Flash, wechselt alle Farben nacheinander während 90 Sekunden und startet dann neu.
 2 flash, cambia tutti i colori uno a uno per 90 secondi e ricomincia.
 2 flashes, muda todas as cores uma a uma durante 90 segundos e volta a começar.
 2 вспышки, изменяет все цвета один за другим в течение 90 секунд и начинает все заново.
 2 błyski, zmienia wszystkie kolory jeden po drugim przez 90 sekund i zaczyna ponownie od początku.
- ★ ★ 4 flash, cambia todos los colores uno a uno durante 330 segundos y vuelve a empezar.
 4 flash, changes all colours one by one for 330 seconds and then starts again.
 4 flashes : change toutes les couleurs une à une pendant 330 secondes et recommence.
 4 Flash, wechselt alle Farben nacheinander während 330 Sekunden und startet dann neu.
 4 flash, cambia tutti i colori uno a uno per 330 secondi e ricomincia.
 4 flashes, muda todas as cores uma a uma durante 330 segundos e volta a começar.
 4 вспышки, изменяет все цвета один за другим в течение 330 секунд и начинает все заново.
 4 błyski, zmienia wszystkie kolory jeden po drugim przez 330 sekund i zaczyna ponownie od początku.

BLANCO / WHITE

Controladores con mando a distancia / Controllers with remote control / Regolatori con telecomando / Controladores com comando à distância / Controller mit Fernbedienung / Контроллеры с пультом дистанционного управления / Kontrolery RGB z pilotem zdalnego sterowania



71-0017-00-00

12 VDC	144W	24 x 84 x 65 mm
24 VDC	288W	



- Controlador de tiras led blancas con tres niveles de regulación de intensidad luminica preprogramados (30%, 60%, 100%) y anillo de control independiente de intensidad luminica. Incorpora un mando a distancia por radiofrecuencia.
- White LED strip controller with three pre-set levels for light intensity regulation (30%, 60% and 100%) and light intensity independent control ring. It incorporates a radio-frequency remote control.
- Contrôleur de bandeaux à LED blancs offrant trois niveaux préprogrammés de réglage d'intensité lumineuse (30 %, 60 %, 100 %) et un anneau de contrôle indépendant de l'intensité lumineuse. Muni d'une télécommande par radiofréquence.
- Regler für weiße LED-Streifen mit drei voreingestellten Intensitätsstufen (30 %, 60 %, 100 %) und unabhängigem Ring zur Justierung der Lichtstärke. Mit Fernbedienung über Funk.
- Controlador de fitas LED blancas com três níveis de regulação de intensidade luminosa pré-progra-

- mados (30%, 60%, 100%) e anel de controlo independente da intensidade luminosa. Incorpora um comando à distância por radiofrecuência.
- Regolatore di strisce led bianche con tre livelli di regolazione di intensità luminosa preprogrammati (30%, 60%, 100%) e anello di controllo indipendente dell'intensità luminosa. Contiene un telecomando a radiofrequenza.
- Контроллер для светодиодных линеек белого света с тремя запрограммированными уровнями яркости (30%, 60%, 100%) и независимое кольцо для контроля яркости освещения. Включен пульт дистанционного радиоуправления.
- Kontrolery białych taśm LED o trzech wcześniej programowanych poziomach regulacji natężenia oświetlenia (30%, 60%, 100%) i obręcz niezależnego sterowania natężeniem oświetlenia. Zawiera pilot zdalnego sterowania częstotliwością radiową.

Equipos de control / Device controllers / Contrôleur gradation / Controller / Dispositivi di controllo / Equipamentos de controlo / Контрольные устройства / Osprzęt sterujący

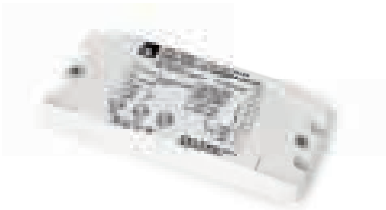

71-0727-00-00

12 VDC	2X 78W
24 VDC	2X 156W

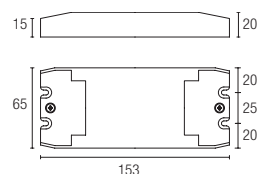

Equipos de control / Device controllers / Contrôleur gradation / Controller / Dispositivi di controllo / Equipamentos de controlo / Контрольные устройства / Osprzęt sterujący



71-3473-00-00

12 VDC	60W
12 VDC	120W

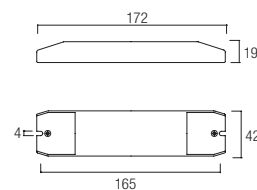

Amplificador / Amplifier / Amplificateur / Verstärker / Amplificatore / Amplificador / Усилитель / Wzmacniacz

RGB / White



71-1553-00-00

12 VDC	4X4 A	IP 20	Dimming	192W	48W	CHANNEL 4
24 VDC				384W	96W	

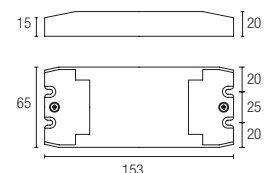



71-9507-05-05 (5) ■



Caja de empotrar válida para las referencias: / Flush-mounted box for references: / Boîtier à encastrer valable pour les références: / Gehäuse zum Einbau, geeignet für Art.-Nr. / Scatola per incasso valida per i riferimenti: / Caixa de encastrar válida para as referências: / Монтажная коробка пригодна для артикулов: / Skrzynka do wbudowania stosowna dla nr referencyjnych: **55-9323 / 55-9187 / 55-9433.**



71-9273-05-05 ■



Caja de empotrar válida para las referencias: / Flush-mounted box for references: / Boîtier à encastrer valable pour les références: / Gehäuse zum Einbau, geeignet für Art.-Nr. / Scatola per incasso valida per i riferimenti: / Caixa de encastrar válida para as referências: / Монтажная коробка пригодна для артикулов: / Skrzynka do wbudowania stosowna dla nr referencyjnych: **05-8961 / 05-9211 / 05-9212.**



71-9744-05-05 ■



NEW

Caja de empotrar específica para techos de homigón. Válido para / Flush-mounted box for concrete ceilings. Valid for / Boîtier à encastrer spécial plafonds en béton. Valable pour / Spezifisches Einbaugehäuse für Betondecken. Geeignet für. / Scatola per incasso specifica per soffitti in calcestruzzo. Adatto per / Caixa de encastrar específica para tectos de betão. Válida para / Специальная монтажная коробка для бетонных потолков. Подходит для / Specjalna skrzynka do wbudowania dla betonowych sufitów. Stosowna dla: **15-9665 / 55-9665 / 55-9666 / 55-9667.**



71-9745-05-05 ■



NEW

Caja de empotrar específica para techos de homigón. Válido para / Flush-mounted box for concrete ceilings. Valid for / Boîtier à encastrer spécial plafonds en béton. Valable pour / Spezifisches Einbaugehäuse für Betondecken. Geeignet für / Scatola per incasso specifica per soffitti in calcestruzzo. / Adatto per / Caixa de encastrar específica para tectos de betão. Válida para / Специальная монтажная коробка для бетонных потолков. Подходит для. / Specjalna skrzynka do wbudowania dla betonowych sufitów. Stosowna dla: **15-9659 / 15-9391 / 15-9392.**



71-9405-M3-M3 ■

IP 65



Accesorio para aumento hasta IP65. Máx. 15W. / Accessory to increase up to IP65. Max 15W. / Accessoire pour augmentation jusqu'à IP65. 15 W maxi. / Zubehör für Erhöhung auf IP65. Max. 15 W / Accessorio per aumentare a IP65. Max 15W. / Acessório para aumento até IP65. Máx. 15 W. / Принадлежность для увеличения до IP65. Макс. 15 Вт. / Akcesorium dla powiększenia do IP65. Maks. 15W.



71-9406-M3-M3 ■

IP 65



Accesorio para aumento hasta IP65. Máx. 20W. / Accessory to increase up to IP65. Max 20W. / Accessoire pour augmentation jusqu'à IP65. 20W maxi. / Zubehör für Erhöhung auf IP65. Max. 20W / Accessorio per aumentare a IP65. Max 20W. / Acessório para aumento até IP65. Máx. 20W / Принадлежность для увеличения до IP65. Макс. 20 Вт. / Akcesorium dla powiększenia do IP65. Maks. 20W.



71-9199-05-05 ■

IP 68

1m



Caja de conexiones estanca / Water proof connection box / Boîtier de raccordement étanche / Hermetischer Anschlusskasten / Scatola di connessioni a tenuta stagna / Caixa de ligação estanque / Герметичная монтажная коробка / Wodoszczelna skrzynka połączeniowa



71-9397-05-05 ■

IP 68

1m



Conector IP 68 2 vias 3 polos completo / IP 68 connection 2 ways 3 wires complete / Connecteur IP68 2 voies 3 pôles complet / IP-Stecker 68 2-Wege 3-polig, komplett / Connettore IP 68 2 vie 3 poli completo / Conector IP 68 2 vias 3 polos completo / Соединитель IP 68 трехполюсный на два входа полный / Pełna złączka IP 68 2-u-jezdna 3-y biegunowa



71-9396-05-05 ■

IP 68

1m



Conector IP68 de 3 vias con forma "T" y 3 polos. Para cables de diámetro 5mm a 13mm. / IP68 3-line 3-pole "T" connector. For cables of 5mm to 13mm diameter. / Connecteur IP68 à 3 voies en forme de T, 3 pôles. Pour câbles de 5 à 13 mm de diamètre. / 3-Wege-Stecker IP68 in T-Form, 3-polig. Für Kabeldurchmesser von 5 mm bis 13 mm. / Connettore IP68 di 3 vie a forma "T" e 3 poli. Per cavi di diametro da 5mm a 13 mm. / Conector IP68 de 3 vias com forma "T" e 3 pólos. Para cabos com diámetro de 5 mm a 13 mm. / Трехполюсный трехфазный соединитель IP68 Т-образной формы. Для кабелей диаметром от 5 мм до 13 мм. / Łącznik IP68 3 drogowy w kształcie litery T i 3 biegunowy. Dla przewodów o średnicy od 5mm do 13mm.



71-9262-05-05 ■



Caja de conexiones estanca. Ø8,5 máx. IP 67 / Water proof connection box. Ø8,5 max. IP 67 / Boîtier de raccordement étanche / Hermetischer Anschlusskasten / Scatola di connessione a tenuta stagna, Ø8,5 max. IP 67 / Caixa de ligações estanque. Ø8,5 máx. IP 67 / Соединитель IP 67 3-х полюсный на три входа / Złącza IP 67 3-y jezdną w kształcie T 3-y biegunowa



71-9311-05-05^(S) ■



Caja de conexiones estanca de medidas / Sealed junction box measuring. / Boîtier de raccordement étanche. / Hermetischer Anschlusskasten der Maße. / Scatola di connessioni impermeabile. / Caixa de ligações estanque. / Водонепроницаемая коробка. / Szczelna skrzynka połączeniowa. 300 x 190 x 120 mm.

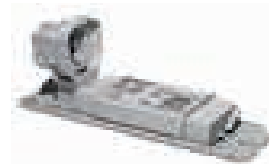

71-8969-00-00 □



Reactancia para / Ballast for / Ballast pour / Vorschaltgerät für / Reattanza per / Reactância para / Реактивное сопротивление для / Reaktancja dla: PL G24d-1 13W 230V

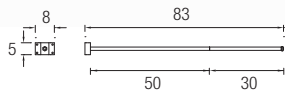

71-9487-34-34 ■



71-9487-25-25 ■

Brazo prolongador con opción a 3 medidas. / Extension arm with 3 measurements. / Bras de prolongement avec option en 3 dimensions / Verlängerungsarm mit 3 möglichen Abmessungen / Braccio prolunga con possibilità di 3 misure. / Braço de prolongamento com 3 medidas opcionais. / Удлиняющий кронштейн; имеется три размера / Wydłużalne ramię z opcją 3 rozmiarów.



71-9746-05-05 ■



NEW

Adecuado para estructuras y columnas cilíndricas de hasta 60 mm de diámetro. / Suitable for cylindrical structures and columns of up to 60 mm in diameter. / Adapté aux structures et colonnes cylindriques de 60 mm de diamètre maximum. / Geeignet für zylinderförmige Strukturen und Säulen bis 60 mm Durchmesser. / Adatto per strutture e colonne cilindriche di fino a 60 mm di diametro. / Adequado para estruturas e colunas cilíndricas com até 60 mm de diámetro. / Подходит для цилиндрических структур и колонн диаметром до 60 мм. / Odpowiedni dla struktur i słupów cylindrycznych o średnicy do 60 mm.



71-4399-14-14 □



Mando a distancia / Remote control / Télécommande / Fernbedienung / Telecomando / Comando a distância / Пульт дистанционного радиоуправления / Pilot zdalnego sterowania



71-1843-81-81 ■



71-1843-CF-CF □

Barras / Bars / Barres / Stangen für / Barre / Barras / балка / poprzeczki 304 mm.

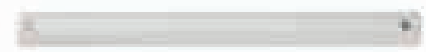

71-1844-81-81 ■



71-1844-CF-CF □

Barras / Bars / Barres / Stangen für / Barre / Barras / балка / poprzeczki 460 mm.

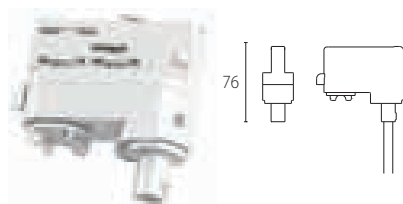

71-2232-14-14 □



71-2232-60-60 ■

Conector de carril / Track connector / Connecteur de rail / Schienenstecker / Collegamento binari / Conector de calha / Соединитель шины / Łącznik szyny



71-2241-00-00



Controlador con mando a distancia / Controller with remote control / Contrôleur avec télécommande / Controller mit Fernbedienung / Regolatore con telecomando / Controlador com comando a distância / Контроллер с дистанционным управлением / Nastawnik z pilotem zdalnego sterowania



**INFORMACIÓN TÉCNICA / TECHNICAL INFORMATION / INFORMATIONS TECHNIQUES / TECHNISCHE ANGABEN /
INFORMAZIONI TECNICHE / INFORMAÇÃO TÉCNICA / ТЕХНИЧЕСКАЯ ИНФОРМАЦИЯ / INFORMACJA TECHNICZNA**

- Para mayor información técnica de las piezas incluidas en este catálogo (instrucciones de montaje, diagramas de instalación, etc.), por favor consulte nuestra página web corporativa
- For further technical information about the parts included in this catalogue (assembly instructions, installation diagrams, etc.), please see our corporate website.
- Pour de plus amples informations techniques concernant les pièces de ce catalogue (consignes de montage, schémas d'installation, etc.), veuillez consulter le site Web de notre entreprise.
- Ausführliche technische Daten zu den Artikeln dieses Katalogs (Montageanleitung, Installationsdiagramme usw.) finden Sie auf unserem Internetportal.
- Per ulteriori informazioni tecniche sui prodotti contenuti in questo catalogo (istruzioni di montaggio, diagrammi di installazione, ecc.) si prega di consultare il nostro sito internet.
- Para informações técnicas mais detalhadas sobre as peças incluídas neste catálogo (instruções de

- montagem, diagramas de instalação, etc.), consulte a nossa página Web empresarial.
- Чтобы подробнее ознакомиться с технической информацией по поводу товаров, включенных в настоящий каталог (инструкции по монтажу, схемы установки и т.п.) посетите наш корпоративный сайт.
- W celu uzyskania szerszej informacji technicznej o elementach zawartych w niniejszym katalogu (instrukcji montażu, diagramów instalacyjnych, itp.) proszę skonsultować się z naszą korporacyjną stroną internetową

Paso
Step
Étape
Schritt
Step
Passo
Шаг
Krok

1

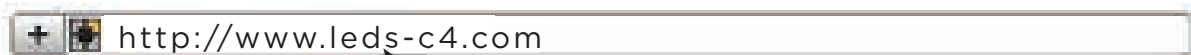

Paso
Step
Étape
Schritt
Step
Passo
Шаг
Krok

2



Paso
Step
Étape
Schritt
Step
Passo
Шаг
Krok

3

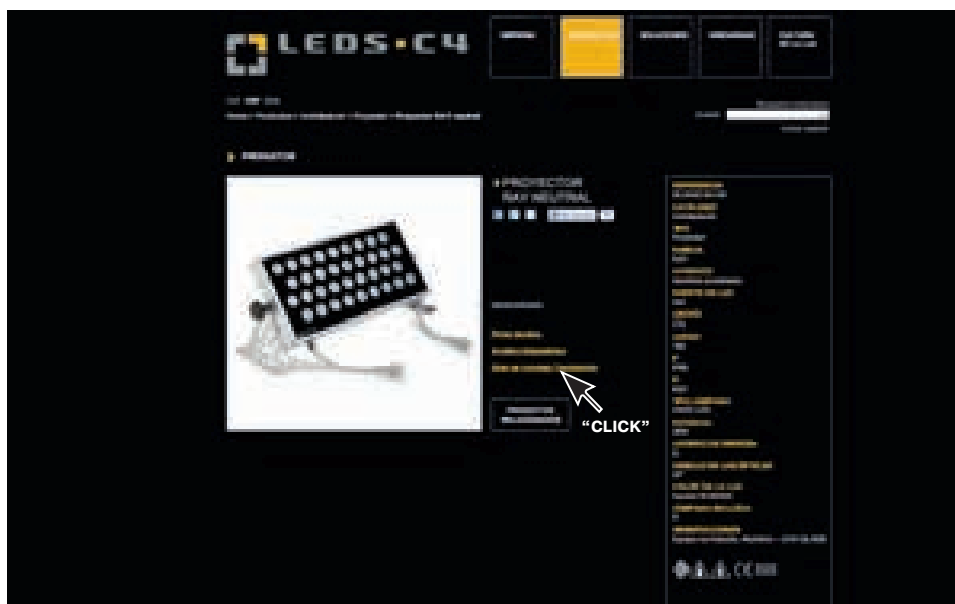



GUIA INSTALACIÓN SERIE RAY
INSTALLATION GUIDE RAY SERIES
INSTALLATIONSANLEITUNG SERIE RAY
GUIDE D'INSTALLATION SÉRIE RAY
GUIDA DI INSTALLAZIONE SERIE RAY

05-3442-54-H6 - NEUTRAL WHITE
05-4669-54-H6 - WARM WHITE
05-3443-54-H6 - RGB

LEDS-C4 S.A.
CIF A-59410910
Afores, s/n
25750 Torà - Lleida - Spain
T +34 973 46 81 00
F +34 973 46 81 06
e-mail: leds-c4@leds-c4.com

v 1.0



RAY SERIE
1

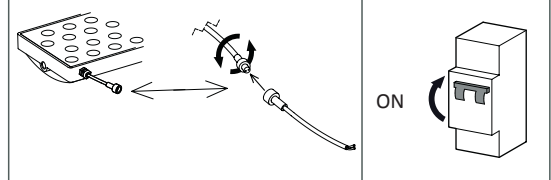
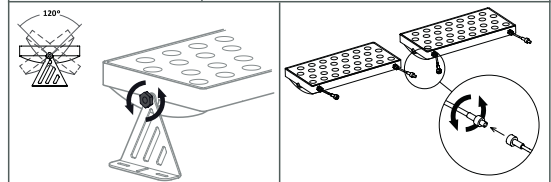
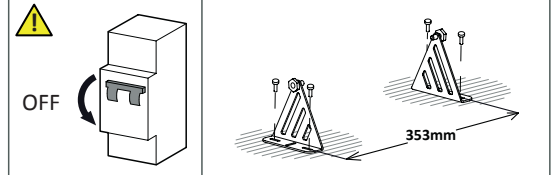
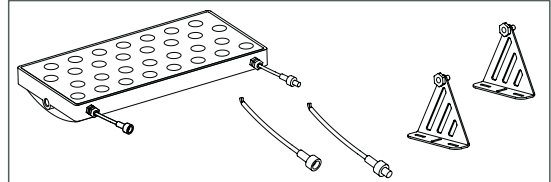

RAY SERIE
2

PS 24vdc	71-0038-00-00 - 26,4 W 71-0039-00-00 - 52,8 W 71-0063-00-00 - 76,8 W 71-0064-00-00 - 156 W 71-0065-00-00 - 340 W 71-0066-00-00 - 312 W 71-4727-00-00 - 150 W (IP67)	C DALI	71-3473-00-00 - 120 W	C WHIT1	71-0017-00-00 - 288 W
A	71-3433-00-00 - 288 W 71-1553-00-00 - 288 W	C DMX	71-3493-00-00 - 192 W	C RGB	71-0019-00-00 - 432 W 71-4662-00-00 - 432 W 71-4663-00-00 - 432 W (IP65) 71-4666-00-00 - REMOTE (optional)

WHITE 05-3442-54-H6 / 05-4669-54-H6 (36W)

ON / OFF

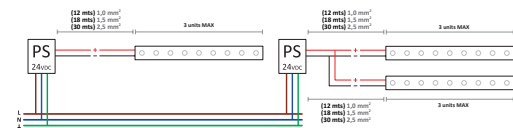

DIMMING WITH REMOTE CONTROL

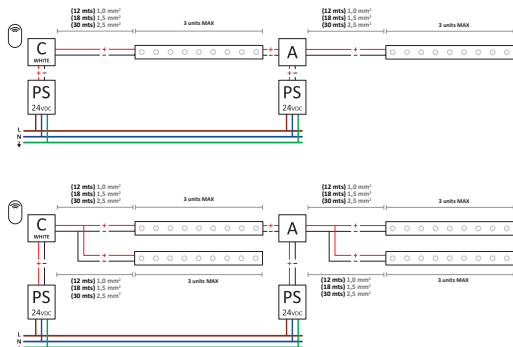

RAY SERIE
3

1-10V

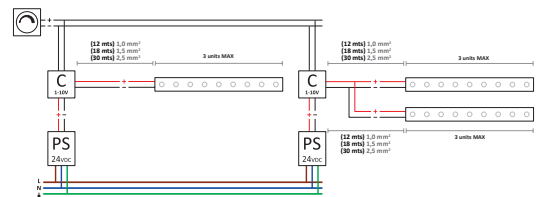

DALI

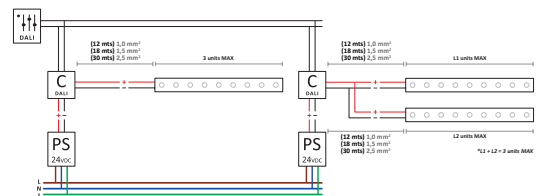

RGB

05-3443-54-H6 (36W)

RGB CONTROL WITH / WITHOUT REMOTE CONTROL

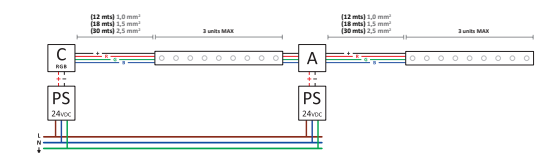

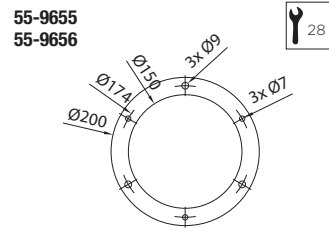
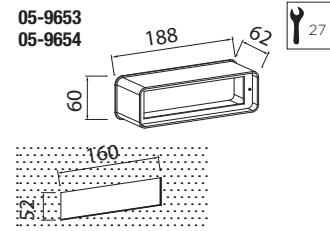
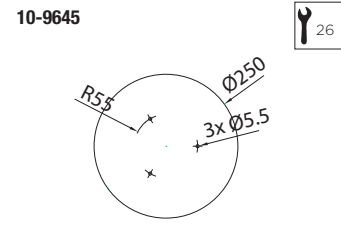
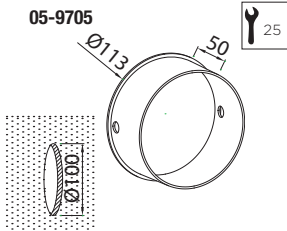
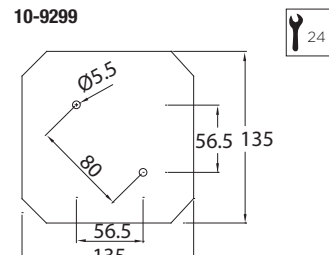
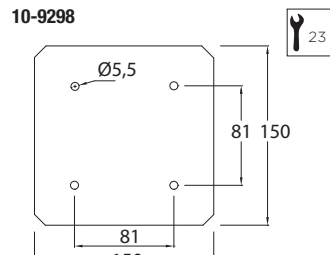
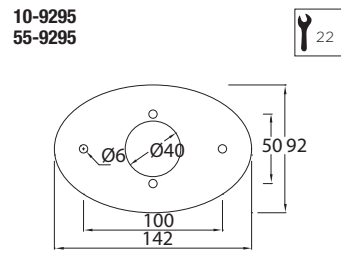
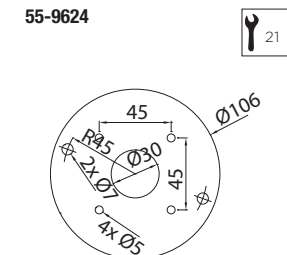
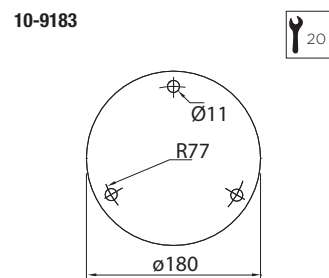
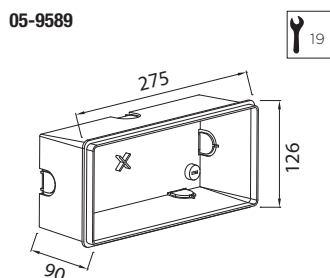
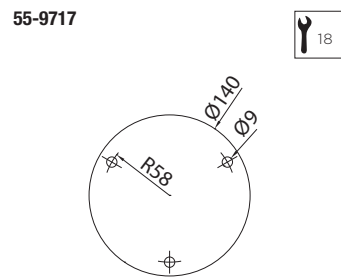
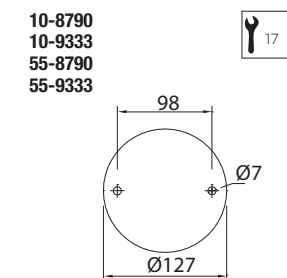
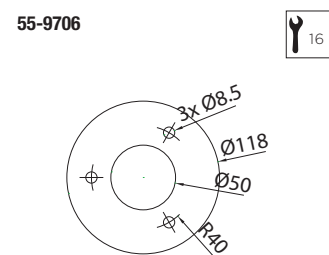
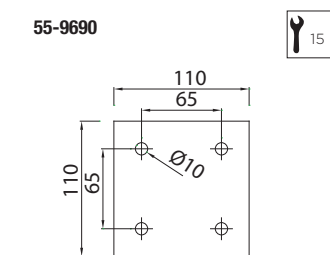
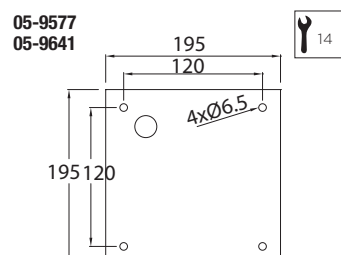
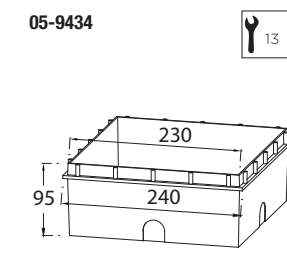
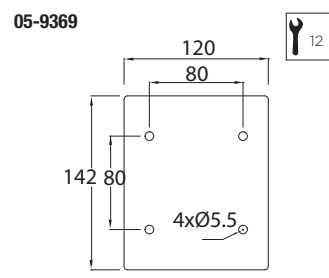
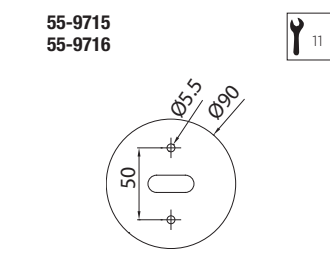
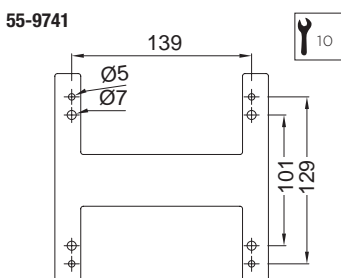
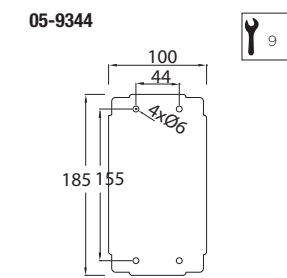
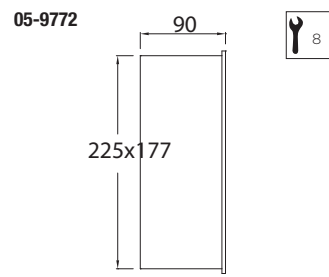
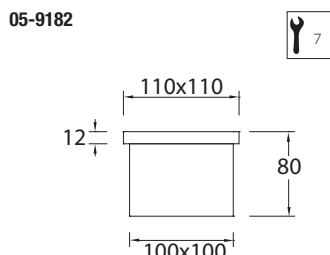
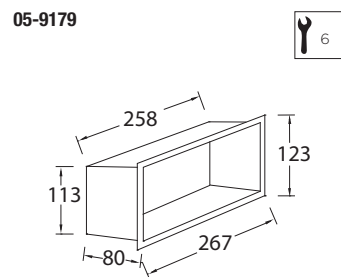
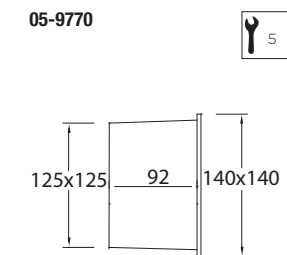
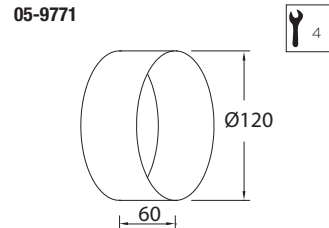
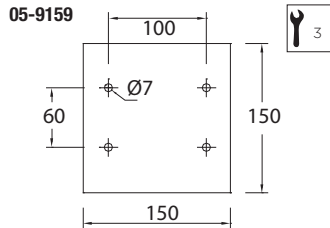
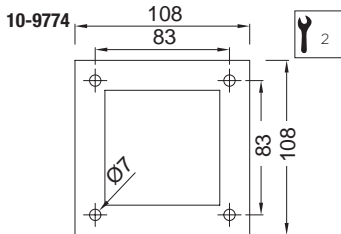
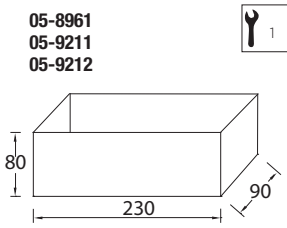

<p>55-9190</p> <p>Wrench icon 29</p>	<p>05-9573 05-9574</p> <p>Wrench icon 30</p>	<p>55-9187 55-9323 55-9433</p> <p>Wrench icon 31</p>	<p>55-9232</p> <p>Wrench icon 32</p>
<p>10-9329 55-9329</p> <p>Wrench icon 33</p>	<p>10-9390</p> <p>Wrench icon 34</p>	<p>10-9475</p> <p>Wrench icon 35</p>	<p>15-9363 15-9365</p> <p>Wrench icon 36</p>
<p>15-9708</p> <p>Wrench icon 37</p>	<p>15-9391 15-9392</p> <p>Wrench icon 38</p>	<p>05-9583</p> <p>Wrench icon 39</p>	<p>55-8956</p> <p>Wrench icon 40</p>
<p>55-9775</p> <p>Wrench icon 41</p>	<p>55-9151</p> <p>Wrench icon 42</p>	<p>55-9184</p> <p>Wrench icon 43</p>	<p>55-9186</p> <p>Wrench icon 44</p>
<p>15-9562</p> <p>Wrench icon 45</p>	<p>55-9620 55-9621 55-9622 55-9623</p> <p>Wrench icon 46</p>	<p>05-9757</p> <p>Wrench icon 47</p>	<p>15-9563</p> <p>Wrench icon 48</p>
<p>55-9488 55-9549</p> <p>Wrench icon 49</p>	<p>55-9550 55-9551 55-9552</p> <p>Wrench icon 50</p>	<p>55-9581 55-9582</p> <p>Wrench icon 51</p>	<p>55-9595</p> <p>Wrench icon 52</p>
<p>55-9657 55-9658</p> <p>Wrench icon 53</p>	<p>15-9659</p> <p>Wrench icon 54</p>	<p>55-9663 55-9664</p> <p>Wrench icon 55</p>	<p>55-9665 55-9666 55-9667</p> <p>Wrench icon 56</p>

<p>55-9257</p>	<p>10-9613 55-9613</p>	<p>55-9264 55-9523 55-9524</p>	<p>55-9265</p>
<p>55-9769</p>	<p>55-9245</p>	<p>10-9607 55-9720 55-9721 55-9605 55-9606 55-9607</p>	<p>55-9255</p>
<p>55-9625</p>	<p>55-9266 55-9527 55-9528</p>	<p>55-9268 55-9269</p>	<p>55-9737 55-9280 55-9281 55-9282 55-9283 55-9380 55-9423 55-9424 55-9567 55-9635 55-9422</p>
<p>55-9233</p>	<p>55-9238</p>	<p>55-9239 55-9440</p>	<p>55-9768</p>
<p>55-9760</p>	<p>55-9293 55-9294</p>	<p>55-9298</p>	<p>55-9459</p>
<p>55-9305</p>	<p>55-9318 55-9319 55-9320 55-9334</p> <p>55-9335 55-9336 55-9342 55-9343</p>	<p>55-9350</p>	<p>55-9486 55-9564</p>
<p>15-9665</p>	<p>55-9669</p>	<p>55-9670</p>	<p>55-9682</p>

<p>55-9759</p>	<p>55-9357</p>	<p>55-9337</p>	<p>55-9358</p>
<p>05-9467</p>	<p>55-9479 55-9530 55-9575</p>	<p>55-9504 55-9505 55-9506</p>	<p>55-9374</p>
<p>05-9596 05-9758</p>	<p>10-9556 10-9557 55-9556 55-9557</p>	<p>55-9390</p>	<p>55-9421</p>
<p>55-9425</p>	<p>55-9427 55-9428 55-9426</p>	<p>55-9430</p>	<p>55-9431</p>
<p>55-9723 55-9724</p>	<p>10-9555 55-9555</p>		

EMPOTRABLES DE TIERRA – DRENAJE

Es imprescindible seguir las instrucciones de montaje y la guía de instalación de los empotrables para lograr el mejor funcionamiento posible de la luminaria.

1. Evitar colocar las luminarias en zonas de depresión del terreno.
2. Evitar colocar las luminarias en zonas donde se pueda acumular agua y en ubicaciones permanentemente húmedas, como jardines o césped.
3. Evitar el uso de productos químicos utilizados para el abono de jardines ya que pueden deteriorar algunos componentes.
4. Nivelar la luminaria con el pavimento.
5. Prever un recubrimiento de dilatación en el caso de empotrables colocados en superficies como el cemento o el hormigón para evitar la posible dilatación o compresión.
6. Colocar un drenaje eficaz para evitar el estancamiento de agua, como mínimo de 25 centímetros de grava por debajo de la carcasa de instalación. Un drenaje correcto debe absorber hasta 10 litros de agua en 15 minutos.
7. Hacer funcionar la luminaria durante 20 minutos sin el cristal para evitar condensaciones de agua dentro.

BUILT-IN FLOOR LUMINAIRES - DRAINAGE

It is essential to follow the assembling instructions and the installation guide of the built-in luminaires in order to achieve the best performance.

1. Avoid installing the luminaires in terrain depressions.
2. Avoid installing the luminaires in areas where water can accumulate and in places that are permanently damp, such as gardens or lawns.
3. Avoid the use of chemical products used to fertilise gardens because they could damage some of the components.
4. Level the luminaire with the surface.
5. Anticipate a dilation coating for built-in luminaires installed on surfaces like cement or concrete, to avoid possible dilation or compression.
6. Install an effective drainage system to avoid the accumulation of water, at least 25 cm of gravel under the installation casing. A correct drainage must absorb up to 10 litres of water in 15 minutes.
7. Put the light on for 20 minutes without the glass to avoid condensation inside.

ENCASTRABLES AU SOL – DRAINAGE

Il est indispensable de suivre les instructions et le guide d'installation des encastrables afin de garantir un éclairage optimum.

1. Eviter l'installation de luminaires dans des zones de dépression de terrain.
2. Eviter l'installation de luminaires dans des espaces où s'accumule de l'eau ou des zones humides telles que jardins ou pelouses.
3. Eviter l'utilisation de produits chimiques utilisés pour le compostage des jardins car ils peuvent détériorer certains composants.
4. Nivelar le terrain en vue de l'installation des luminaires.
5. Prévoir un recouvrement pour la dilatation dans le cas de luminaires encastrables installés en surface tel que le ciment ou le béton, afin d'éviter une possible dilatation ou compression.
6. Poser un drain efficace afin d'éviter toute stagnation de l'eau, avec un minimum de 25 centimètres de gravier en dessous de l'installation. Un drain efficace doit permettre d'absorber jusqu'à 10 litres d'eau en 15 minutes.
7. Faire fonctionner le luminaire pendant 20 minutes, sans le verre, afin d'éviter toute condensation d'eau à l'intérieur.

BODENEINBAULEUCHTEN – DRAINAGE

Die Montageanweisungen und Anleitungen des Handbuchs für die Installation der Bodeneinbauleuchten sind unbedingt zu befolgen, um den bestmöglichen Betrieb der Beleuchtungskörper gewährleisten zu können.

1. Vermeiden Sie die Montage der Beleuchtungskörper in abschüssigem Gelände.
2. Vermeiden Sie die Montage der Beleuchtungskörper in Bereichen der Wasseransammlung und in Feuchtzonen, wie Gärten und Rasenflächen.
3. Vermeiden Sie die Verwendung von chemischen Gartendüngemitteln, da diese einen schädlichen Einfluss auf einige der Komponenten ausüben können.
4. Bringen Sie den Beleuchtungskörper und den Bodenbelag auf eine Höhe.
5. Sorgen Sie beim Einbau der Beleuchtungskörper in Zement- oder Betonflächen für eine geeignete Ummantelung, um eine eventuelle Ausdehnung oder ein Zusammenpressen zu verhindern.
6. Bauen Sie ein wirksames Drainagesystem ein, um das Anstauen von Wasser zu vermeiden, wobei ein Kiesbett von mindestens 25 cm unter dem Einbaugeschäube vorhanden sein muss. Bei einer korrekten Drainage müssen bis zu 10 Liter Wasser in 15 Minuten absorbiert werden.
7. Nehmen Sie den Beleuchtungskörper 20 Minuten lang ohne Deckglas in Betrieb, um eine Kondensierung des Wassers im Inneren der Leuchte zu vermeiden.

ELEMENTI DA INCASSARE AL SUOLO - DRENAGGIO

È indispensabile seguire le istruzioni di montaggio e la guida di installazione degli elementi ad incasso per garantire il migliore funzionamento possibile.

1. Evitare di collocare i faretti in zone depresse del terreno.
2. Evitare di collocare i faretti in zone in cui possa accumularsi acqua e in ubicazioni permanentemente umide, come giardini o prati.
3. Evitare l'uso dei prodotti chimici usati per la concimazione di giardini, dal momento che potrebbero deteriorare alcuni componenti del faretto.
4. Collocare il faretto a livello del suolo.
5. Prevedere una giunta di dilatazione nel caso di elementi ad incasso collocati in superfici come cemento e calcestruzzo, per evitare la possibile dilatazione o compressione.
6. Disporre un drenaggio efficace per evitare il ristagno dell'acqua, come minimo di 25 centimetri di ghiaia al di sotto della carcassa di installazione. Un drenaggio corretto deve assorbire fino a 10 litri di acqua in 15 minuti.
7. Far funzionare il faretto per 20 minuti senza il vetro per evitare che al suo interno di formi condensatione.

ENCASTRÁVEIS DE TERRA – DRENAGEM

É imprescindível que siga as instruções de montagem e o guia de instalação dos encastráveis para obter o melhor funcionamento possível do aparelho de iluminação.

1. Evite colocar os aparelhos de iluminação em zonas de depressão do terreno.
2. Evite Coloque os aparelhos de iluminação em zonas onde se possa acumular água e em localizações permanentemente húmidas, como jardins ou relva.
3. Evite o uso de produtos químicos utilizados para o adubamento de jardins, dado que eles podem deteriorar alguns componentes.
4. Nivele o aparelho de iluminação pelo pavimento.
5. Preveja um revestimento de dilatação no caso de encastráveis colocados em superfícies como o cimento ou o betão para evitar a eventual dilatação ou compressão.
6. Coloque uma drenagem eficaz para evitar a estagnação da água, no mínimo de 25 centímetros de gravilha abaixo da carcaça de instalação. Uma drenagem correcta deve absorver até 10 litros de água em 15 minutos.
7. Faça funcionar o aparelho de iluminação durante 20 minutos sem o vidro para evitar condensações de água dentro dele.

ВСТРОЕННЫЕ НАПОЛЬНЫЕ ОСВЕТИТЕЛЬНЫЕ ПРИБОРЫ – ДРЕНАЖ

Для обеспечения оптимальной работы осветительного прибора необходимо в точности следовать инструкциям и пособию по установке для встроенных приборов.

1. Не устанавливать осветительные приборы во впадинах.
2. Не устанавливать осветительные приборы на участках, предрасположенных к скоплению воды и в местах с повышенным содержанием влаги, таких, как, например, сады или газоны.
3. Попадание химических удобрений, используемых для садовых растений, может повредить поверхность лампы.
4. Устанавливать осветительные приборы на уровне поверхности.
5. Предусмотреть нанесение покрытия в случае установки осветительных приборов на таких поверхностях как цемент или бетон, для предотвращения возможного расширения или сжатия.
6. Установить эффективный дренаж для задержки воды, как минимум в 25 см гравия расположенного под структурой осветительного прибора. Адекватная дренажная система должна абсорбировать до 10 литров воды в течении 15 минут
7. Включить осветительный прибор за 20 минут до установки стекла для предотвращения водной конденсации.

WBUDOWYWANE OPRAWY PODŁOGOWE – DRENAŻ

Aby osiągnąć najlepszą wydajność należy bezwzględnie stosować się do instrukcji montażu lamp wbudowywanych.

1. Unikaj montowania opraw w zagłębieniach terenu.
2. Unikaj stosowania opraw w miejscach gdzie często zbiera się woda lub miejscach wilgotnych takich jak ogrody i trawniki.
3. Unikaj kontaktu opraw z nawozami, ponieważ mogą one zniszczyć części opraw.
4. Wypoziomować oprawy.
5. Zastosować przerwy dylatacyjne przy montażu opraw w betonie, aby zapobiec ścisnaniu i rozszerzaniu.
6. Zastosować system drenażowy pod oprawą – co najmniej 25cm żwiru pod dnem oprawy. Właściwy drenaż powinien przepuszczać 10 litrów wody w 15 min.
7. Uruchom lampę na 20 minut bez przykrycia celem odparowania wilgoci.



Tabla de resistencia a la corrosión Acero inoxidable / Corrosion resistance table of Stainless steel / Tableau de résistance à la corrosion de l'acier inoxydable / Korrosionsfeste Platte aus rostfreiem Stahl / Tabola di resistenza alla corrosione dell'acciaio / Tabela de resistência à corrosão do aço inoxidável / Таблица о ржавоустойчивости нержавеющей стали / TABELA OCHRONY ANTYKOROZYJNEJ STALI NIERDZEWNEJ

	AISI 202	AISI 304	AISI 316		AISI 202	AISI 304	AISI 316
Agua doméstica / Domestic water / Eau ménagère / Haushaltswasser / Acqua domestica / Água doméstica / Хозяйственно-бытовая вода / Woda domowa	OK	OK	OK	Vapor de agua / Water vapor / Vapeur d'eau / Wasserdampf / Vapore di acqua / Vapor de água / Пар / Para wodna	OK	OK	OK
Agua doméstica conteniendo cloro / Domestic water containing chloride / Eau ménagère contenant du chlore / Chlorenhaltendes Haushaltswasser / Acqua domestica contenente di cloro / Água doméstica contendo cloro / Хозяйственно-бытовая вода с хлором / Woda domowa z chlorem	X	X	OK	Limpiadores químicos quita cemento / Chemical cleaning for use on cement / Nettoyeurs chimiques lève ciment / Chemische Reiniger zur Zemententfernung / Prodotti chimici di pulizia per il cemento / Limpadores químicos para a remoção de cimento / Химические чистящие средства для цемента / Środki czyszczące do betonu	X	X	X
Agua de mar / Sea water / Eau de mer / Meerwasser / Acqua di mare / Água do mar / Морская вода / Woda morską	X	X	OK	Suelos con un PH alto o alcalinos / Floors with high PH or alkaline values / Terres avec un pH haut ou alcalins / Böden mit hohem PH-Wert oder alkalische Böden / Pavimenti con alto PH ed alcalini / Terrenos com um PH alto ou alcalinos / Поверхности с высоким водородным показателем или щелочные / Podlogi o wysokim pH i odczynie kwasowym	X	X	OK
Aire / Air / Luft / Aria / Ar / Воздух / Powietrze	OK	OK	OK	Fertilizantes y abonos químicos / Fertilizers and chemical fertilizers / Fertilisants et engrais chimiques / Düngemittel und chemische Dünger / Fertilizantes e prodotti chimici / Fertilizantes e adubos químicos / Удобрения и химические удобрения / Nawozy i nawozy szluczne	X	X	X
Atmósfera marina / Marine atmosphere / Atmosphère marine / Meeresatmosphäre / Atmosfera marina / Atmosfera marinha / Приморская атмосфера / Powietrze nadmorskie	X	X	OK				

LIMPIEZA Y MANTENIMIENTO DEL ACERO INOXIDABLE

Por su excelente resistencia y belleza, el acero inoxidable es un material de fácil conservación, tendiéndose a veces a tener la errónea idea de que no requiere mantenimiento. Pero es necesario seguir unas recomendaciones mínimas durante su almacenamiento manipulación y uso. Una limpieza adecuada permiten mantener inalteradas sus características originales, preservando su resistencia a la corrosión y apariencia.

Durante las tareas de limpieza, asegurar que se eliminan las acumulaciones de contaminantes llevados por el aire. Esto es muy importante en lugares industriales o marítimos ya que pueden provocar corrosión localizada si no se eliminan eficazmente.

Para eliminar la suciedad sobre la superficie, se debe utilizar un paño húmedo o una gamuza. En caso de suciedad más difícil, utilizar detergentes suaves de uso doméstico con estropajos o cepillos suaves de nylon (no usar estropajos de acero). Después de limpiar, elimine los residuos con agua desionizada y seque la superficie.

La frecuencia para una limpieza regular es de 6-12 meses para una suciedad moderada y de 3-6 meses cuando es más abundante, o para ambientes en que se den las siguientes condiciones:

- atmósferas marinas - ambientes repletos de contaminantes industriales - sal pulverizada proveniente de la sal utilizada en carreteras - suciedad atmosférica y del tráfico.

No deben usarse limpiadores que contengan cloruros ni lejías. Encontrará información más detallada en: www.leds-c4.com

CLEANING AND MAINTENANCE OF STAINLESS STEEL

Stainless steel is a highly resistant beautiful material being easy to conserve. However, it does require maintenance. For this reason, it is necessary to follow some minimum recommendations during its storage, manipulation and use. Correct cleaning preserves its original characteristics, especially its resistance to corrosion.

During cleaning it is important to clean the contaminating agents which are present in the atmosphere. This is particularly the case in industrial places or close to a marine environment, as these areas can cause localized corrosion if they are not efficiently eliminated.

A damp cloth or chamois leather cloth should be used to eliminate the dirt on the surface. In case of extra dirt, gentle detergents suitable for domestic use should be used with non abrasive scrubbers or nylon brushes (no metal scrubbers). After cleaning wipe away the residue with water and dry surface.

The recommended frequency is every 6-12 months for moderate dirt and 3-6 months for heavy dirt or for the following situation:

- Marine atmosphere - Industrial contaminated areas - Salt from road gritting - Dirt from traffic.

No cleaning agents that contain chloride or bleach should be used. You can find further information at: www.leds-c4.com

NETTOYAGE ET ENTRETIEN DE L'ACIER INOXYDABLE

Du fait de son excellente résistance et de sa beauté, l'acier inoxydable est un matériau facile à conserver. Il exige toutefois plus d'entretien qu'on ne le pense. Il convient de respecter des consignes élémentaires pendant le stockage, la manipulation et l'utilisation de ce matériau. Un nettoyage adéquat permet d'en maintenir les caractéristiques initiales inchangées et d'en préserver la résistance à la corrosion ainsi que l'apparence.

Pendant le nettoyage, veillez à éliminer les accumulations de contaminants présents dans l'air. Cela est très important en milieu industriel ou marin car ces particules risquent de provoquer une corrosion localisée si elles ne sont pas éliminées efficacement.

Pour éliminer les salissures de la surface, il convient d'utiliser un chiffon humide ou une peau de chamois. En cas d'impuretés plus tenaces, utilisez des détergents doux à usage ménager combinés à des éponges ou brosses douces en nylon (pas d'éponge métallique). Après le nettoyage, éliminez les résidus avec de l'eau déionisée et séchez la surface.

Il est conseillé de nettoyer tous les 6-12 mois en cas de salissures modérées et tous les 3-6 mois en cas de salissures plus incrustées ainsi que dans les circonstances suivantes : milieu marin, milieu riche en contaminants industriels, projections de sel d'épandage, impuretés atmosphériques et dues à la circulation routière.

N'utilisez pas de produits nettoyants contenant des chlorures ou de l'eau de javel.

Vous trouverez de plus amples informations sur le site : www.leds-c4.com

REINIGUNG UND INSTANDHALTUNG VON ROSTFREIEM STAHL

Aufgrund seiner hohen Beständigkeit und seines attraktiven Erscheinungsbildes ist rostfreier Stahl ein einfach instand zu haltendes Material. Viele neigen daher zur irrtümlichen Annahme, dass rostfreier Stahl keine Wartung benötigt. Nichtsdestoweniger sollte man sich bei seiner Lagerung, Handhabung und seinem Gebrauch an gewisse Mindestanweisungen halten. Eine angemessene Reinigung trägt dazu bei, seine Eigenschaften im ursprünglichen Zustand zu erhalten, seine Korrosionsbeständigkeit zu erhöhen und sein attraktives Aussehen zu bewahren.

Während der Reinigung sollte man darauf achten, dass alle verunreinigenden Stoffe, die durch die Luft auf das Metall übertragen wurden, vollkommen entfernt werden. Dies ist besonders in den Bereichen der Industrie und der Seefahrt wichtig, denn werden diese Stoffe nicht auf wirksame Weise entfernt, so können sie an bestimmten Stellen Korrosionserscheinungen hervorrufen.

Für die Entfernung der Verunreinigungen von der Oberfläche ist ein feuchtes Tuch oder ein Wischlappen zu benutzen. Bei hartnäckigem Schmutz können milde Haushaltsreiniger mit weichen Scheuerlappen oder Nylonbürsten (keine Scheuerschwämme aus Stahl verwenden) eingesetzt werden. Danach müssen die Rückstände des Reinigers mit entionisiertem Wasser abgespült und die Oberfläche abgetrocknet werden.

Eine regelmäßige Reinigung sollte bei mässigem Schmutzbefall alle 6-12 Monate durchgeführt werden, bzw. alle 3-6 Monate bei stärkerem Schmutzbefall oder bei Vorliegen der folgenden Bedingungen:

- im Meerwasserbereich - in Bereichen mit starker industriell bedingter Verschmutzung - bei Einwirkung von Streusalz, das auf den Straßen eingesetzt wird - wetter- oder verkehrsbedingter Schmutzbefall.

Es dürfen keine Reiniger benutzt werden, die Chloride oder Laugen enthalten.

Ausführlichere Information finden Sie in: www.leds-c4.com

PULIZIA E MANTENIMENTO DELL'ACCIAIO INOSSIDABILE

Per sua particolare resistenza e bellezza, l'acciaio inossidabile è un materiale di facile conservazione, è però necessaria una po' di manutenzione.

È necessario seguire qualche raccomandazione durante l'immagazzinamento, manipolazione ed uso. La pulizia appropriata permette di conservare la sua caratteristica originale, non solo la resistenza alla corrosione ed il suo aspetto.

Durante la pulizia, bisogna assicurarsi che gli accumuli di sostanze contaminanti portate dall'aria siano rimossi. Ciò è particolarmente importante in ambienti marini ed industriali, questi possono dar luogo a corrosione localizzata, se non rimossi accuratamente.

Per rimuovere uno sporco leggero o le impronte, è consigliabile usare un panno umido o di pelle scamosciata. Invece per lo sporco più consistente è consigliabile usare dei prodotti di uso domestico, spugnette oppure spazzole soffici (assolutamente non usare pagliette abrasive o metalliche). Dopo aver effettuato un'appropriate pulizia, rimuovere i residui con acqua preferibilmente deionizzata ed asciugare.

Si consiglia una pulizia ogni 6-12 mesi per uno sporco leggero, ed ogni 3-6 mesi per quello più pesante derivante dagli ambienti sotto citati:

- atmosfera marine - ambienti carichi di prodotti industriali inquinanti - spruzzi di acqua contenenti il sale anti ghiaccio sparso sulle strade - inquinamento atmosferico e da traffico.

Non devono essere usati dei prodotti contenenti cloruri e neanche candeggine a base di acido ipoclorico. Troverete informazioni più specifiche sul sito: www.leds-c4.com

LIPEZA E MANUTENÇÃO DO AÇO INOXIDÁVEL

Dada a sua excelente resistência e beleza, o aço inoxidável é um material de conservação fácil, tendendo-se por vezes a ficar com a ideia de que não necessita de manutenção. No entanto é necessário que se sigam recomendações mínimas durante o seu armazenamento, manuseamento e uso. Uma limpeza adequada permite que se mantenham inalteradas as suas características originais, preservando a sua resistência à corrosão e o seu aspecto.

Durante as tarefas de limpeza, certifique-se de que são eliminadas as acumulações de contaminantes transportados pelo ar. Isto é muito importante em locais industriais ou marítimos, dado que tais contaminantes podem provocar corrosão localizada se não forem eficazmente eliminados.

Para eliminar a sujidade existente à sua superfície, deve-se utilizar um pano húmido ou uma camuza. No caso de sujidade mais difícil, devem ser utilizados detergentes suaves de uso doméstico, com esfregões ou escovas suaves de nylon (não se devem usar esfregões de aço). Depois da limpeza, devem ser eliminados os resíduos com água desionizada e secar a superfície.

Para uma limpeza regular, a frequência é de 6-12 meses para sujidade moderada e de 3-6 meses para sujidade mais abundante, ou para ambientes em que se verifiquem as condições seguintes:

- atmosferas marinhas - ambientes repletos de contaminantes industriais - sal pulverizado proveniente do sal utilizado nas estradas - sujidade atmosférica e do trânsito.

Não se devem usar produtos de limpeza que contenham cloratos ou lixívia. Pode encontrar informações mais detalhadas em: www.leds-c4.com

ЧИСТКА И УХОД ЗА НЕРЖАВЕЮЩЕЙ СТАЛЬЮ

Благодаря своим эстетическим характеристикам и долголетию, нержавеющая сталь является материалом, способным при ее правильном уходе сохранять свой первоначальный вид очень долгое время. Необходимо придерживаться минимальных рекомендаций распространяющихся на уход, хранение и использование. Адекватная чистка позволит сохранить первоначальные качества, а также внешний вид и устойчивость к ржавчине. В процессе чистки обратите внимание на удаление с поверхности всего накопившегося загрязнения.

Важно следовать этому требованию в промышленных или приморских районах, так как неправильная чистка может привести к образованию ржавчины.

Используйте влажную тряпку или кусок замши для удаления грязи с поверхности. При особом загрязнении используйте мягкие моющие средства для домашнего пользования, и мягкие скребки или нейлоновые шётки (не допускайте использование металлических шёток). После чистки сполосните водой и высушите поверхность.

При среднем загрязнении чистка должна производиться через каждые 6-12 месяцев, и каждые 3-6 месяцев при сильном загрязнении или при наличии следующих условий окружающей среды:

- приморский район - при сильном промышленном загрязнении - использовании соли на дорогах.

Не использовать чистящие средства, содержащие хлор или отбеливатель

Вы сможете получить дополнительную информацию, зайдя на интернет-страницу www.leds-c4.com

CZYSzcZENIE I KONSERWACJA STALI NIERDZEWNEJ

Stal nierdzewna to piękny i wysoce odporny materiał łatwy w konserwacji. Mimo to, należy o niego dbać. Dlatego ważne jest aby przeszedzając kilka zasad przy przechowywaniu, obróbce i użytkowaniu stali nierdzewnej. Ważne czyszczenie utrzymuje właściwości fizyczne, a w szczególności odporność na korozję.

Czyszcząc ważne jest użycie substancji niekorzystnie wpływających na stal, obecnych w atmosferze. Ważne jest to zwłaszcza w otoczeniu przemysłowym lub morskim, gdzie niedokładnie wyczyszczone powierzchnie mogą powodować miejscową korozję. Wilgotna ściereczka, lub ściereczka zamiatkowa powinny być używane do czyszczenia stali nierdzewnej. W przypadku mocniejszych zabrudzeń można użyć domowych detergentów i nie metalowej szorstki. Po czyszczeniu należy powierzchnię zmyć wodą i wytrzeć do sucha. Zaleca się czyszczenie co 6-12 miesięcy przy niskim zanieczyszczeniu, i co 3-6 miesięcy przy wysokim zanieczyszczeniu lub w następujących warunkach:

- morska atmosfera - miejscska skażone przemysłowo - sól do posypywania dróg - bród z ruchu kołowego - nie stosować środków zawierających chlor lub wybielacz.

Więcej informacji na www.leds-polska.pl

	ESPAÑOL	ENGLISH	FRANÇAIS	DEUTSCH
	Clase I	Class I	Classe I	Klasse I
	Clase II	Class II	Classe II	Klasse II
	Clase III	Class III	Classe III	Klasse III
	Sistema de codificación para indicar el grado de protección proporcionado por un envoltorio contra la entrada de elementos sólidos y líquidos	A coding system that shows the degree of protection that a casing provides against the penetration of solid objects or dust and liquids	Système de codification permettant d'indiquer le degré de protection procuré par une enveloppe contre la pénétration de corps solides, poussières et liquides	Dieses Codierungssystem dient zur Angabe des Schutzgrades, der mit einer besonderen Verkleidung zum Schutz gegen das Eindringen fester Gegenstände, Staub oder Flüssigkeiten erreicht wird
	Sistema de codificación para indicar el grado de protección proporcionado por un envoltorio contra los impactos mecánicos nocivos. Energía de impacto (Jules)	It is a coding system that shows the level of protection that a casing provides against damaging mechanical impacts. Energy of impact (Jules)	Système de codification permettant d'indiquer le degré de protection procuré par une enveloppe contre les impacts mécaniques nuisibles. Energie d'impact (en Joules)	Dieses Codierungssystem dient zur Angabe des Schutzgrades, der mit einer besonderen Verkleidung zum Schutz gegen schädliche mechanische Einflüsse erreicht wird. Schlagenergie (Joule)
	Luminarias no adecuadas para cubrirse con material aislante térmico	Luminaires should never be covered with any heat insulating material	Ces luminaires ne doivent pas être recouverts de matériau thermo-isolant	Nicht geeignet für eine Installation in einer isolierten Decke
	Luminarias no adecuadas para el montaje directo en superficies normalmente inflamables	Non suitable for direct installation on normally inflammable surfaces	Luminaires inadéquates pour le montage direct sur des surfaces qui sont normalement inflammables	Montage auf normal entflammabaren Oberflächen nicht zulässig
	Resistente al hilo incandescente a 850°C	Resistance to incandescent wire at 850°C	Tenue au feu 850°C	Glühdrahtbeständig auf 850°C
	Distancia mínima entre el foco de la luminaria y el objeto iluminado	Minimum distance to be left between the focus of the lighting fixture and the lightened object	Distance minimale entre le foyer du luminaire et l'objet éclairé	Mindestabstand zwischen dem Scheinwerfer der Leuchte und dem beleuchteten Gegenstand
	Uso independiente	Independent use	Utilisation indépendante	Unabhängiger Betrieb
	Diámetro de empotramiento	Hole diameter for recessing	Diamètre d'encastrement	Einbaudurchmesser
	Corte de empotramiento.	Hole dimensions for recessing	Coupe d'encastrement	Einbauschnitt
	Producto para empotrar o de superficie	Surface-mount or recessed product	Produit à encastrer ou de surface	Produkt zum Einbau und zur Oberflächenmontage
	Los anclajes permiten su instalación en techos de X mm a X mm	The fixing can be used on X mm - X mm ceilings	Les fixations permettent d'installer le modèle sur des plafonds de X à X mm	Die Federn gestatten eine Installation an Decken von X mm bis X mm
	Equipo no incluido	Gear not included	Équipement non compris	Vorschaltgerät nicht inklusive
	Equipo electrónico	Electronic gear	Équipement électronique	Elektronisches Vorschaltgerät
	Equipo magnético	Magnetic gear	Équipement magnétique	Magnetisches Vorschaltgerät
	Unidades de embalaje	Items per box	Unité d'emballage	Verpackungseinheiten
	Ver página xxx	See page xxx	Voir page XXX	Siehe Seite XXX
	Modelos registrados	Registered models	Modèles enregistrés	Eingetragene Modelle
	Luz cálida	Warm light	Lumière chaude	Warmweißes Licht
	Luz natural	Natural light	Lumière naturelle	Neutralweißes Licht
	Luz fría	Cold light	Lumière froide	Kalt-weisses Licht
	Luz RGB	RGB light	Lumière RGB	RGB Licht
	Flujo nominal basado en condiciones reales de trabajo (25°C<Ts<90°C). La salida de flujo real de la luminaria dependerá de las condiciones ambientales y la eficacia óptica de la luminaria	Nominal flux based on real working conditions (25°C<Ts<90°C). The real output flux of the luminaire will depend on environmental conditions and the optical efficiency of the luminaire	Flux nominal basé sur des conditions de fonctionnement réelles (25°C<Ts<90°C). La sortie de flux réel du luminaire dépend des conditions environnementales et de l'efficacité optique du luminaire	Nominal-Lichtfluss basierend auf tatsächlichen Betriebsbedingungen (25°C<Ts<90°C). Der tatsächliche Lichtfluss der Leuchte hängt von den Bedingungen am Aufstellort und dem optischen Wirkungsgrad der Leuchte ab



























	ITALIANO	PORTUGUÊS	РУССКИЙ ЯЗЫК	POLSKI
	Classe I	Classe I	Класс I	Klasa I
	Classe II	Classe II	Класс II	Klasa II
	Classe III	Classe III	Класс III	Klasa III
	Sistema di codificazione per indicare il grado di protezione offerto da un involucro contro la penetrazione di oggetti solidi, di polvere, o di liquidi	Sistema de codificação para a indicação do grau de proteção proporcionado por um invólucro contra a penetração de objectos sólidos ou pó e líquidos	Система кодирования для обозначения степени защиты обеспечиваемой корпусом против попадания твердых и жидких элементов	System kodowania wskazujący na stopień ochrony przed wnikaniem ciał obcych, kurzu i wody
	Sistema di codificazione per indicare il grado di protezione fornito da un rivestimento contro gli impatti meccanici dannosi. Energia di impatto (Joule)	Sistema de codificação para indicar o grau de proteção proporcionado por um invólucro contra os impactos mecânicos nocivos. Energia de impacto (Jules)	Система кодирования для обозначения степени защиты обеспечиваемой корпусом от механических ударов. Сила удара (в Дж)	System kodowania dla wskazania stopnia ochrony obudowy przed szkodliwym uderzeniom mechanicznym. Energia uderzenia (Dzule)
	Apparecchi inappropriati per essere coperti con materiale isolante termico	Estas luminárias não podem ser cobertas com material isolante térmico	Не допускается теплоизоляция данных светильников	Oprawy nigdy nie powinny być przykrywane materiałem izolującym ciepło
	Apparecchi inappropriati per montaggio su superfici infiammabili	Estas luminárias não podem ser montadas diretamente sobre superfícies normalmente inflamáveis	Не допускается установка данных светильников на легковоспламеняющихся поверхностях	Nie instalować bezpośrednio na powierzchniach łatwopalnych.
	Resistente a filo incandescente 850°C	Resistente ao fio incandescente a 850°C	Прошло испытание спиралью накаливания 850°C	Odpornośćna drut żarowy o temperaturze 850°C
	Distanza minima tra la lampada e l'oggetto illuminato	Distância mínima entre o foco da luminária e o objecto iluminado	Минимальное расстояние между световым фокусом и освещаемым объектом	Minimalna odległość do zachowania pomiędzy czołem lampy a oświetlanym obiektem
	Uso indipendente	Utilização independente	Независимое использование	Niezależne zastosowanie
	Diametro di incasso	Diâmetro de encastramento	Диаметр отверстия для встраиваемого монтажа	Średnica wbudowania
	Foro di incasso	Corte de encastramento	Размер отверстия для встраиваемого монтажа	Przekrój wbudowania
	Prodotto da incasso o di superficie	Prodotto para encastrar ou de superficie	Встраиваемый продукт или продукт для монтажа на поверхности	Produkt do wbudowania lub na powierzchnię
	I fissaggi consentono l'installazione dell'articolo su soffitti da X mm a X mm	As fixações permitem a sua instalação em tectos de X mm a X mm	Зажимы обеспечивают монтаж на потолках толщиной от X мм до X мм	Kotwienia pozwalają na jego zainstalowanie na sufitach wynoszących od X mm do X mm
	Trasformatore non incluso	Equipamento nao incluído	Оборудование не включено	Zasilacz nie dołączony
	Dispositivo elettronico	Aparelho electrónico	Электронный балласт	Osprzęt elektroniczny
	Dispositivo magnetico	Equipamento magnético	Магнитный балласт	Osprzęt magnetyczny
	Unità d'imballaggio	Uds. de embalagem	Количество единиц в коробке	Sztuk w pudełku
	Consultare pagina XXX	Ver página XXX	См. стр. XXX	Zobacz stronę XXX
	Modelli registrati	Modelos registados	Зарегистрированные модели	Modele zastrzeżone
	Luce calda	Luz quente	Теплый белый свет	Ciepłe światło
	Luce naturale	Luz naturale	Светло-белый свет	Naturalny biały światło
	Luce fredda	Luz fredda	Холодный белый свет	Zimne światło
	Luce RGB	Luz RGB	Свет RGB	Światło RGB
	Flusso nominale basato su condizioni reali di funzionamento (25°C<Ts<90°C). L'uscita del flusso reale dalla lampada dipenderà dalle condizioni ambientali e dall'efficienza ottica della lampada	Fluxo nominal baseado em condições reais de trabalho (25°C<Ts<90 °C). A saída de fluxo real da luminária dependerá das condições ambientais e da eficácia ótica da luminária	Номинальный поток на основе фактических условий работы (25°C<Ts<90°C). Фактический выход светового потока зависит от условий окружающей среды и оптической эффективности светильника	Znamionowy strumień oparty na rzeczywistych warunkach pracy (25°C<Ts<90°C). Wylot rzeczywistego strumienia z oprawy oświetleniowej będzie zależał od warunków środowiskowych i wydajności optycznej oprawy oświetleniowej.

	ESPAÑOL	ENGLISH	FRANÇAIS	DEUTSCH
$lm^{(R)}$	Flujo real de la luminaria teniendo en cuenta la eficacia óptica de la luminaria y las condiciones reales de trabajo (60°C < Ts < 90°C)	Real flux of the luminaire taking into account the optical efficiency of the luminaire and the real working conditions (60°C < Ts < 90°C)	Flux réel du luminaire compte tenu de l'efficacité optique du luminaire et des conditions de fonctionnement réelles (60°C < Ts < 90°C)	Tatsächlicher Lichtfluss der Leuchte unter Berücksichtigung des optischen Wirkungsgrads der Leuchte und den tatsächlichen Betriebsbedingungen (60°C < Ts < 90°C)
	Regulador de intensidad	Dimmer	Régulateur d'intensité	Mit dimmer
	Grados de inclinación	Inclination degrees	Degrés d'inclinaison	Neigungsgrad
(S)	Consultar disponibilidad	Check availability	Vérifiez la disponibilité	Bitte nach Verfügbarkeit fragen
	Eficiencia	Efficiency	Efficience	Effizienz
	Tensión de entrada	Supply voltage	Tension d'entrée	Eingangsspannung
	Intensidad de corriente máxima	Maximum current intensity	Intensité de courant maximale	Maximale Stromstärke
	Amperios	Ampères	Ampères	Ampere
	Corriente continua	Direct current	Courant continu	Gleichstrom
	Corriente alterna	Altern current	Courant alternatif	Altern Strom
	Exterior	Outdoor	Extérieur	Außen
	Interior	Indoor	Intérieur	Innen
	Años de garantía sujetos a condicionantes de instalación y uso	Years of guarantee subject to correct use and installation	Années de garantie soumises aux conditions d'installation et d'utilisation	Garantiejahre gemäss Ausstattungs- und Gebrauchsbeschränkungen
	Extensión de garantía de urban 3 años	Warranty extension up to 3 years	Extension de garantie de jusqu'à 3 ans	Verlängerung der Garantie auf bis 3 Jahre
	Extensión de garantía de urban 5 años	Warranty extension up to 5 years	Extension de garantie de jusqu'à 5 ans	Verlängerung der Garantie auf bis 5 Jahre
	Años de garantía del motor, sujetos a condicionantes de instalación y uso	Years guarantee for the motor, subject to conditions of use and installation	Années de garantie du moteur soumises aux conditions d'installation et d'utilisation	Jahre Garantie auf den Motor bei sachgemäßer Installation und Nutzung
	Vida útil	Lamp life	Durée de vie utile	Nutzungsdauer
	Vida del LED	LED lifetime	Durée de vie de la LED	Lebensdauer der LED
	Interruptor de encendido	On•off switch	Interrupteur simple allumage	Schalter
	Doble interruptor de encendido	Double on•off switch	Interrupteur double allumage	Doppel Schalter
	Interruptor de encendido en el cable	Cable on•off switch	Interrupteur d'allumage sur le câble	Schalter am Kabel
	Interruptor de cuerda	Pull cord switch	Interrupteur a ficelle	Strickschalter
	Regulador de intensidad	Dimmer	Régulateur d'intensité	Mit dimmer
	Apto para posición vertical y horizontal	Suitable for vertical and horizontal mounting	Installation en position verticale et horizontale	Schenkrecht und waagrecht geeignet
	Conexión USB integrada	USB port	Connexion usb intégrée	Integriertes USB Verbindung



















ITALIANO	PORTUGUÊS	РУССКИЙ ЯЗЫК	POLSKI
Flusso reale della lampada tenendo in considerazione l'efficienza ottica della lampada e le condizioni reali di funzionamento (60°C<Ts<90°C)	Fluxo real da luminária tendo em conta a eficácia ótica da luminária e as condições reais de trabalho (60°C<Ts<90°C)	Фактический выход светового потока с учетом оптической эффективности светильника и фактических условий работы (60°C<Ts<90°C)	Rzeczywisty strumień z oprawy oświetleniowej biorąc pod uwagę wydajność optyczną oprawy oświetleniowej i rzeczywiste warunki pracy (60°C<Ts<90°C)
Regolatore d'intensità	Com regulador de intensidade	Регулятор яркости	Ściemniacz
Gradi di inclinazione	Graus de inclinação	Угол регулировки	Stopnie uchyłu
Verificare la disponibilità	Consultar disponibilidade	Проверить наличие	Dostępność
Efficienza	Eficiência	Эффективность	Skuteczność
Tensione d'entrata	Tensão de entrada	Напряжение на входе	Napięcie zasilania
Intensità di corrente massima	Intensidade de corrente máxima	Максимальный ток	Maksymalne natężenie prądu
Ampere	Amperes	Амперы	Amperów
Corrente continua	Corrente continua	Постоянный ток	Prąd stały
Corrente alternata	Corrente alternada	Переменный ток	Prąd przemienny
Esterno	Exterior	Для внешнего освещения	Zewnętrzny
Interno	Interior	Для внутреннего освещения	Wewnętrzny
La garanzia è subordinata alla corretta installazione ed al corretto uso	Anos de garantia sujeitos a condicionantes de instalação e utilização	Лет гарантии при условии правильного монтажа и эксплуатации	Lat gwarancji pod warunkami poprawnej instalacji i użytkowania
Prolungamento della garanzia fino a 3 anni	Extensão de garantia até 3 anos	Продление гарантии до 3 лет	Przedłużenie gwarancji do 3 lat
Prolungamento della garanzia fino a 5 anni	Extensão de garantia até 5 anos	Продление гарантии до 5 лет	Przedłużenie gwarancji do 5 lat
Anni di garanzia del motore, soggetta a condizioni di installazione ed utilizzo	Anos de garantia do motor, sujeitos a condicionantes de instalação e uso	год(лет) гарантии на мотор в зависимости от условий содержания и использования	lat gwarancji na silnik, przy właściwych warunkach użytkowania i instalacji
Vita utile	Vida útil	Срок службы	Okres eksploatacji
Vita del LED	Vida do LED	Срок службы светодиода	Okres eksploatacji LED
Interruttore di accensione	Interruptor on•off	Клавишный выключатель	Włącznik
Doppio interruttore di accensione	Duplo interruptor on•off	Два клавишных выключателя	Włącznik podwójny
Interruttore d'accensione nel cavo	Cabo com interruptor on-off	Выключатель на проводе	Wyłącznik w przewodzie
Interruttore di corda	Interruptor de cordão	Веревочный выключатель	Włącznik sznurowy
Con regolatore d'intensità	Com regulador de intensidade	Регулятор яркости	Ciemniacz
Adatto in verticale ed in orizzontale	Apto para posição vertical e horizontal	Вертикально-горизонтальное расположение	Montaż poziomy i pionowy
Connessione usb integrata	Ligação usb integrada	Встроенный USB	Zintegrowane złącze USB

	ESPAÑOL	ENGLISH	FRANÇAIS	DEUTSCH
	Orientable	Adjustable	Orientable	Verstellbar
	No orientable	Non adjustable	Non orientable	Nicht verstellbar
	Espejo de aumento x3	Magnifying mirror x3	Miroir grossissant x3	3-fach Vergrößerungsspiegel
	Dirección del halo de luz	Halo light direction	Direction du faisceau lumineux	Halo Lichtrichtung
	Mando a distancia	Remote control	Télécommande	Fernbedienung
	Mando a distancia no incluido	Remote control not included	Télécommande non compris	Fernbedienung nicht inklusive
	Controlador con mando a distancia	Controller with remote control	Contrôleur avec télécommande	Controller mit Fernbedienung
	Mando a distancia por radiofrecuencia	Remote control	Commande à distance par radiofréquence	Hochfrequenz-Fernbedienung
	Toma de corriente	Socket	Prise de courant	Stromanschluss
	3 Velocidades	3 Speeds	3 Vitesses	3 Geschwindigkeiten
	Revoluciones por minuto	Revolutions per minute	Révolutions par minute	Umdrehungen pro Minute
	Silencioso	Quiet	Silencieux	Ruhig
	Función inversa	Reverse function	Fonction inverse	Winter-und Sommerbetrieb
	Palas reversibles	Reversible blades	Lames réversibles	Zweifarbige umkehrbare Flügel
	Barras	Downrods	Barres	Stangen
	Ahorro	Savings	Économies	Einsparung
	Ahorro energético del X%	Up to X% energy saving	Économie d'énergie de X %	Energieersparnis von X %
	Fotometría	Photometric Data	Données photométriques	Fotometrie
	Equivalente a	Brighter as	Eclaire comme	Heller wie
	Metros cuadrados iluminados con una unidad del producto	Square meters illuminated by each product unit	Mètres carrés éclairés avec une unité du produit	Mit einer Mengeneinheit beleuchtete Quadratmeter
	Ángulo de detección	Detection angle	Angle de détection	Ortungswinkel
	Distancia de detección	Detection distance	Distance de détection	Ortungsabstand
	Permite regular el tiempo de encendido	Allows you to regulate the time for the "on" switch	Permet de régler la durée d'allumage	Regulierung der Einschaltzeit möglich
	Permite regular la sensibilidad del sensor	Allows you to regulate the sensor sensitivity	Permet de régler la sensibilité du capteur	Regulierung der Sensorempfindlichkeit möglich
	Duración máxima de encendido continuado	Maximum duration of continual usage	Durée maximale d'allumage continu	Maximale durchgängige Einschaltzeit
	Tiempo necesario para una carga completa de la batería	Time necessary to fully charge the battery	Délai nécessaire pour une charge complète de la batterie	Akkuladedauer



























	ITALIANO	PORTUGUÊS	РУССКИЙ ЯЗЫК	POLSKI
	Orientabile	Ajustável	Регулируемый	Regulowane
	Non orientabile	Não orientável	Нерегулируемый	Nieregulowane
	Lente d'ingrandimento x3	Espelho de aumento x3	Зеркало с увеличением x3	Lustro powiększające x3
	Direzione del fascio	Direcção do feixe de luz	Направление света	Kierunek łuny światła
	Telecomando	Comando à distância	Пульт управления	Pilot zdalnego sterowania
	Telecomando non incluso	Comando à distância nao incluído	Пульт управления не включен	Pilot zdalnego sterowania nie dołączony
	Regolatore con telecomando	Controlador com comando à distância	Контроллер с дистанционным управлением	Nastawnik z pilotem zdalnego sterowania
	Telecomando a radiofrequenza	Comando à distância por radiofrequência	Пульт дистанционного радиоуправления	Pilot zdalnego sterowania częstotliwością radiową
	Presi di corrente	Tomada de corrente	С выходом для проводного подключения	Gniazdo
	3 velocità	3 velocidades	3 скорости	3 prędkości
	Evoluzioni al minuto	Rotações por minuto	Вращений в минуту	Obroty na minutę
	Silenzioso	Silencioso	Бесшумно	Cichy
	Funzione inversa	Função inversa	функция обратного движения	Funkcja odwrotna
	Lame reversibili	Lâminas revogáveis	Двухсторонние сменные лопасти	Obracalne śmigła
	Barre	Barras	балка	poprzeczki
	Risparmio	Poupança	сбережение	Oszczędności
	Risparmio energetico del X%	Poupança energética de X%	Экономия электроэнергии в %	Oszczędność energetyczna wynosząca X%
	Fotometria	Fotometria	Фотометрия	Fotometria
	Pari a	Equivalente a	Равняется	Odpowiada
	Metri quadrati illuminati con un'unità del prodotto	Metros quadrados iluminados com uma unidade do produto	Площадь, освещаемая одним прибором (м кв.)	Metrów kwadratowych oświetlonych jedną jednostką produktu
	Angolo di rilevamento	Ângulo de detecção	Угол обнаружения	Kąt wykrywania
	Distanza di rilevamento	Distância de detecção	Дистанция обнаружения	Odległość wykrywania
	Consente di regolare il tempo di accensione	Permite regular o tempo de acendimento	Позволяет регулировать продолжительность свечения	Pozwala na regulowanie czasu palenia się
	Consente di regolare la sensibilità del sensore	Permite regular a sensibilidade do sensor	Позволяет регулировать чувствительность датчика	Pozwala na regulowanie czułości czujnika
	Durata massima di accensione continuata	Duração máxima de acendimento contínuo	Максимальная продолжительность непрерывного свечения	Maksymalny czas ciągłego palenia się
	Tempo necessario per una ricarica completa della batteria	Tempo necessário para a carga completa da bateria	Время, необходимое для полного заряда батареи	Czas potrzebny do pełnego naładowania baterii

	ESPAÑOL	ENGLISH	FRANÇAIS	DEUTSCH
	Pilas incluidas	Batteries included	Piles fournies	Batterien inklusive
	Ángulo de la ópticas	Lents angle	Angle des lentilles	Ausstrahlwinkel der Linsen
	Canales	Channels	Canales	Kanäle
	xx cambios de color	xx changing colorus	xx changements de couleur	xx Farben
	Nº de metros máx. de conexión en serie	Max. no. of metres in serial connection	Longueur max. (en mètres) de raccordement en série	Max. Länge in Metern bei Reihenanschluss
	Posibilidad de cortar cada x leds	Option to cut every x leds	Mètres de connexion continue	Möglichkeit zu schneiden je x LED
	x metros de cable	x meters of cable	x mètre de câble	x Meter langes Kabel
	Cabezales con rotación de XX°	X° rotatable end caps	Têtes à rotation de X°	Köpfe mit XGrad-Drehung
	Reflector direccional	Directional reflector	Réflecteur directionnel	Eibaustrahler
	Excelente disipación del calor	Excellent heat conduction	Excellente dissipation de la chaleur	Ausgezeichnete Wärmedissipation
	Disipación activa	Active dissipation	Dissipateur de chaleur intégré	Aktive Wärmeableitung
	Panal de abeja	Honeycomb	Rayon de miel	Honigwabe
	Filtro	Filter	Filtre	Filter
	Aletas antideslumbrantes	Anti-glare directional flaps	Ailettes anti-éblouissement	Blendschutzflügel
	Grosor del cromo	Chrome thickness	Épaisseur du chrome	Chromdicke
	Rango de temperatura de trabajo	Range of operating temperature	Plage de température de travail	Bereich der Betriebstemperatur
	Caja para empotrar incluida	Recessed box included	Bôte à encastrer incluse	Einbaubox inklusive
	Doble salida de cable	Double cable output	Double sortie de câble	Zwei Kabelausgänge
	Empotrable para zona peatonal	Downlight for pedestrian crossing	Encastré pour zone piétonnière	Einbauleuchte für Fussgängerübergang
	ATENCIÓN - Esta luminaria puede soportar una carga estática limitada. ES APTA para zonas donde eventualmente circulan vehículos a baja velocidad. NO ES APTA para zonas de paso habitual de vehículos	ATTENTION - This light fixture can withstand a limited static load. SUITABLE for areas with low-speed vehicles. NON SUITABLE for high traffic areas	ATTENTION - Ce luminaire peut supporter une charge statique limitée. IL EST ADAPTÉ aux zones de circulation occasionnelle de véhicules à basse vitesse. IL N'EST PAS ADAPTÉ aux zones de circulation habituelle de véhicules	ACHTUNG - Diese Leuchte kann eine statische Belastung halten. Die Leuchte ist GEEIGNET für eventuell Kriechverkehr-Bereiche. Die Leuchte ist NICHT GEEIGNET für Fahrzeug-Verkehrsbereiche
	Drenaje	Drainage	Drainage	Dränage
	Estaca de plástico incluida	Plastic spike included	Piquet en plastique inclus	Erdspieß inklusive
	Accesorio reflector incluido	Reflector accessory included	Accessoire réflecteur compris	Zubehör, Reflektor inklusive
	Guía de instalación	Installation guide	Guide d'installation	Einbauanleitung
	Mantenimiento sin herramientas	Maintenance without tools	Entretien sans outils	Instandhaltung ohne Werkzeuge
	Cristal de recambio de cortesía	Courtesy spare glass included	Verre rechange compris	Zusätzliche Ersatzteile aus Glas zum Auswechseln
	Temperatura en la superficie menor de 40°C	Temperature on the surface under 40°C	Température de surface inférieure à 40°C	Oberflächentemperatur unter 40°C

	ITALIANO	PORTUGUÊS	РУССКИЙ ЯЗЫК	POLSKI
	Pile incluse	Pilhas incluídas	Батарейки в комплекте	Łącznie z bateriami
	Angolo delle lenti	Ângulo das lentes	Угол отражения оптической части	Kąt układu optycznego
	Canali	Canais	Каналы	Kanałów
	xx cambiamenti di colori	xx mudaça de cor	xx вариантов цвета	xx zmiennych kolorów
	N° massimo di metri di connessione in serie	N° de metros máximo de ligação em série	Максимальное кол-во метров для подключения в серии	Maksymalna długość w m przy połączeniu szeregowym
	Possibilità di tagliare ogni x led	N° de metros máximo de ligação em série	Возможность среза через каждые x светодиодов	Możliwość cięcia co x LEDów
	x metri di cavo	x metros de cabo	x метров провода	x metrów przewodu
	Testine con rotazione di X°	Cabeças com rotação de X°	Шарниры с углом поворота в X°	Głowice o obrocie wynoszącym X°
	Riflettore direzionale	Reflector direccional	Рефлектор направленности света	Reflektor regulowany
	Eccellente dissipazione del calore	Excelente dissipação do calor	Отличное рассеивание света	Doskonałe rozpraszanie ciepła
	Dissipazione attiva	Dissipação activa	Система охлаждения	Aktywne odprowadzanie ciepła
	Struttura a nido di vespe	Estrutura tipo "favo de mel"	Płyta o strukturze plastra miodu	Coty
	Filtro	Filtro	Filtr	Фильтр
	Alette rompiflusso	Alhetas anti-encandeamento	Kłapy przeciwośnieniowe	Protiwoslepiące zaslonki
	Spessore del cromo	Espessura do cromado	Толщина хромирования	Grubość chromu
	Livello di temperatura di esercizio	Intervalo de temperatura de funcionamento	Разброс рабочей температуры	Zakres temperatury pracy
	Involucro per l'incasso incluso	Caixa para embutir incluída	Корпус-коробка из технополимера для встраивания прилагается	Корпус-коробка прилагается
	Cavo a doppia uscita	Dupla saída de cabos	Двойной выход для кабеля	Podwójne gniazdo kabla
	Carrabile per zona pedonale	Embutido para zona de pedestres	Локальный светильник для пешеходного перехода	Downlight na przejścia dla pieszych
	ATTENZIONE - Questa lampada è in grado di sopportare un carico statico limitato. È VALIDO in zone stradali con traffico a bassa velocità. NON È VALIDO per zone stradali con traffico a velocità media	ATENÇÃO - Esta luminária pode suportar uma carga estática limitada. É ADEQUADA para zonas onde, eventualmente, circulem veículos a baixa velocidade. INADEQUADA para zonas de passagem habitual de veículos	ВНИМАНИЕ - Данный светильник выдерживает статическую ограниченное статическое напряжение. ПРИГОДЕН на участках периодического передвижения транспорта на низкой скорости. НЕ ПРИГОДЕН на участках постоянного движения транспортного потока	UWAGA - Ta oprawa może wytrzymać ograniczone natężenie statyczne. Właściwa dla mało uczęszczanych miejsc. Niewłaściwa dla miejsc o wysokim ruchu kołowym
	Drenaggio	Drenagem	Дренаж	Drenaż
	Palo in plastica incluso	Vara de plástico incluída	Пластиковый шип прилагается	Plastikowy szpikulec w komplecie
	Accessori riflettore incluso	Accessório reflector incluído	Прилагается отражающий аксессуар	Części reflektorowe w komplecie
	Guida di installazione	Guia de instalação	Пособие по установке	Instrukcja instalacji
	Manutenzione senza attrezzi	Manutenção sem ferramentas	Техническое обслуживание без инструментов	Obsługa beznarzędziowa
	Vetro di ricambio omaggio	Vidro de reposto incluído	Бесплатно прилагается запасное стекло	Zapasowe szkło w komplecie
	Temperatura alla superficie minore di 40 °C	Temperatura na superfície inferior a 40°C	Температура поверхности менее 40°C	Temperatura powierzchni poniżej 40 °C

	ESPAÑOL	ENGLISH	FRANÇAIS	DEUTSCH
40-80°C	Temperatura en la superficie entre 40 y 80°C	Temperature on the surface between 40 and 80°C	Température de surface comprise entre 40 et 80°C	Oberflächentemperatur zwischen 40 und 80°C
>80°C	Temperatura en la superficie superior a 80°C	Temperature on the surface over 80°C	Température de surface supérieure à 80°C	Oberflächentemperatur über 80°C
	Temperatura máxima en la superficie de la luminaria	Highest temperature on the surface	Température maximale à la superficie du luminaire	Leuchtenoberfläche max. Temperatur
	Filtro Difusor	Difuser Filter	Filtre diffuseur	Filter Diffusor
	Filtro 3000K	3000K Filter	Filtre 3000°K	Filter 3.000° Kelvin
	Fotometría asimétrica	Asymmetrical photometry	Photométrie asymétrique	Asymmetrische Fotometrie
	Fotometría simétrica	Symmetrical photometry	Photométrie symétrique	Symmetrische Fotometrie
	Cumplimiento con las normativas vigentes anticontaminación luminaria	According to regulations in force about luminic pollution	Conforme à la réglementation en vigueur contre la pollution lumineuse	Erfüllung der geltenden Vorschriften über Grenzwerte der Lichtverschmutzung
	Protección térmica	Thermal cut-off	Protection thermique.	Thermischer Schutz
	Luminaria	Luminaire	Luminaire	Leuchte
	Bloque óptico	Optical Assembly	Bloc optique	Optikgehäuse
	2N = Luminaria con doble nivel de potencia por línea de mando. Incluye conmutador instalado en el interior de la luminaria para permitir un 40% de reducción del consumo. Requiere una señal adicional (por cable) desde el cuadro de conexionado general hasta la luminaria para activar o desactivar la reducción	2N=Luminaire with a double power level per line of command. It includes a switch installed inside the luminaire to allow a 40% reduction in consumption. It requires an additional signal (by cable) from the general junction box to the luminaire in order to activate or deactivate the reduction	2N (bi-puissance) = luminaire à double niveau de puissance par ligne de commande. Comprend un commutateur installé à l'intérieur du luminaire pour permettre une réduction de consommation de 40 %. Exige un signal supplémentaire (par câble) depuis le boîtier de raccordement général jusqu'au luminaire pour activer ou désactiver la réduction	2N = Leuchte mit doppeltem Leistungsniveau pro Befehlszeile. Einschließlich Schalter im Inneren der Leuchte zur Senkung des Verbrauchs um 40 %. Benötigt ein zusätzliches Signal (per Kabel von der allgemeinen Schalttafel an die Leuchte), um den Stromverbrauch herunterzufahren
	2N TEMP = Luminaria con doble nivel de potencia temporizado. No requiere ningún cable adicional desde el cuadro de conexionado general. La luminaria ya incluye un conmutador temporizado para permitir una reducción del 40% del consumo durante unas horas.	2N TEMP = Luminaire with a double timed power level. It does not require an additional cable from the general junction box. The luminaire already includes a timer switch to allow a 40% reduction in consumption for several hours.	2N (bi-puissance) = luminaire à double niveau de puissance temporisé. N'exige aucun câble supplémentaire depuis le boîtier de raccordement général. Le luminaire est déjà muni d'un commutateur temporisé pour permettre de réduire la consommation de 40 % pendant quelques heures.	2N TEMP = Leuchte mit mit doppeltem Leistungsniveau per Zeitschaltung. Keine zusätzliches Verkabelung notwendig. Die Leuchte enthält einen Zeitschalter, um während bestimmter Perioden den Verbrauch um 40 % zu reduzieren.
	Permite instalación LATERAL de ØXmm	LATERAL installation for ØXmm	Permet une installation LATÉRALE de ØX mm	Geeignet zur SEITLICHEN Installation mit Ø X mm
	Permite instalación TOP de ØXmm	TOP installation for ØXmm	Permet une installation SUPÉRIEURE de ØX mm	Geeignet zur Installation OBEN mit Ø X mm
	Luminaria certificada por el Instituto de Astrofísica de Canarias	Luminaire certified by the Institute of Astrophysics of Canary Islands	Luminaire certifié par l'Institut d'astrophysique des Îles Canaries	Leuchte vom Instituto de Astrofísica de Canarias zertifiziert
ULOR	Flujo Hemisferio Superior (FHS)	Upper hemisferic luminous flux (light pollution percentage)	Flux lumineux vers l'hémisphère supérieur (FHS)	Upper hemisferic luminous flux (Lichtverschmutzung)
HPS	Vapor de sodio a alta presión (VSAP)	High pressure sodium	Vapeur de sodium à haute pression (SHP)	Hochdruck-Natriumdamp
MH	Halogenuros metálicos (HM)	Metal halide	Iodures métalliques (IM)	Metallhalogenid
	Columna	Column	Mât	Mast
	Pernos	Bolts	Boulons	Bolzen
	Plantilla	Plate	Gabarit	Schablone
	Cruz simple	Single bracket	Croix simple	Einfaches Kreuz
	Cruz doble	Double bracket	Croix double	Doppelkreuz

	ITALIANO	PORTUGUÊS	РУССКИЙ ЯЗЫК	POLSKI
	Temperatura alla superficie tra 40 e 80 °C	Temperatura na superfície entre 40 e 80°C	Температура поверхности между 40 и 80°C	Temperatura powierzchni pomiędzy 40 a 80 °C
	Temperatura alla superficie superiore di 80 °C	Temperatura na superfície superior a 80°C	Температура поверхности выше 80°C	Temperatura powierzchni powyżej 80 °C
	Temperatura massima alla superficie dell'apparecchio	Temperatura máxima da superfície da luminária	Максимальная температура поверхности осветительного прибора	Najwyższa temperatura powierzchni
	Filtro Diffusore	Filtro Difusor	Фильтр Диффузор	Filtr Rozpraszający
	Filtro 3.000K	Filtro 3.000K	Фильтр 3.000K	Filtr 3000K
	Fotometria asimmetrica	Fotometria assimétrica	Асимметричная фотометрия	Fotometria asymetryczna
	Fotometria simmetrica	Fotometria simétrica	Fotometria symetryczna	Fotometria symetryczna
	In linea con le normative vigenti anti-inquinamento luminoso	Cumprimento da legislação em vigor sobre medidas contra a poluição luminosa	Соответствует действующим нормам по борьбе со световым загрязнением	W zgodzie z przepisami dotyczącymi zanieczyszczenia światłem
	Protezione termica	Proteção térmica	Тепловая защита	Zabezpieczenie termiczne
	Luce	Luminária	Светильник	Oprawa oświetleniowa
	Blocco ottico	Bloco ótico	Оптический блок	Blok optyczny
	2N = Luce con doppio livello di potenza per linea di comando. Include commutatore installato all'interno della lampada per consentire un 40% di riduzione del consumo. Necessita di un segnale aggiuntivo (via cavo) dal quadro di connessione generale alla luce per attivare o disattivare la riduzione	2N = Luminária com duplo nível de potência por linha de comando. Inclui comutador instalado no interior da luminária para permitir 40% de redução do consumo. Requer um sinal adicional (por cabo) a partir do quadro de ligação geral até à luminária para ativar ou desativar a redução	2N = Светильник с двумя уровнями мощности на контрольную линию. В комплект входит переключатель, смонтированный внутри светильника, чтобы обеспечить 40% сокращения потребления. Требуется дополнительного сигнала (кабель) от коробки подключения к светильнику, чтобы включить или отключить сокращение потребления	2N = Oprawa oświetleniowa z podwójnym poziomem mocy za pomocą linii sterowniczej. Zawiera przełącznik zainstalowany wewnątrz oprawy oświetleniowej pozwalający na 40% obniżenie poboru. Wymaga dodatkowego sygnału (przewodem) od tablicy podłączenia ogólnego do oprawy oświetleniowej w celu aktywowania i deaktywowania tej obniżki
	2N TEMP = Luce con doppio livello di potenza con timer. Non necessita di nessun cavo aggiuntivo dal quadro di connessione generale. La luce include già un commutatore con timer per consentire una riduzione del 40% del consumo per ora.	2N TEMP = Luminária com duplo nível de potência temporizado. Não requer nenhum cabo adicional a partir do quadro de ligação geral. A luminária já inclui um comutador temporizado para permitir uma redução de 40% do consumo durante algumas horas.	2N TEMP = Светильник с двумя уровнями мощности с таймером. Не требует проводки дополнительного кабеля от коробки подключения. Светильник имеет переключатель с таймером, который позволяет уменьшить потребление на 40% в течение нескольких часов.	2N TEMP = Oprawa oświetleniowa z podwójnym poziomem mocy dawkującym czas. Nie wymaga żadnego dodatkowego przewodu od tablicy podłączenia ogólnego. Oprawa oświetleniowa już zawiera przełącznik dawkujący czas pozwalający na 40% obniżenie poboru przez kilka godzin.
	Consente installazione LATERALE di ØXmm	Permite instalação LATERAL com Ø de X mm	Позволяет БОКОВУЮ установку ØX мм	Umożliwia montaż poziomy
	Consente installazione SUPERIORE di ØXmm	Permite instalação TOP com Ø de X mm	Позволяет ВЕРХНИЮ установку ØX мм	Umożliwia montaż poziomy
	Luce certificata dall'Istituto di Astrofisica delle Canarie	Luminária certificada pelo Instituto de Astrofísica de Canárias	Светильники, сертифицированные Институтом астрофизики Канарских островов	Oprawa certyfikowana przez instytut astrofizyki wysp kanaryjskich
	Flusso emisfero superiore	Fluxo luminoso emitido acima do plano horizontal (FHS)	Световой поток верхнего полушария	Strumień półprzestrzenny górny (SPG)
	Sodio ad alta pressione	Vapor de sódio de alta pressão (VSAP)	Натриевая газоразрядная лампа (VSAP)	Wysokociśnieniowy sód (WCS)
	Alogenuri metallici (AM)	Halogenetos metálicos (HM)	Металлогалогенные лампы (МГЛ)	Halogenki metali (HM)
	Colonna	Coluna	Колонка	Stup
	Bulloni	Parafusos	Болты	Śruby
	Placca	Placa	Панель	Szablon
	Piastrina semplice	Cruz simples	Одноместный кронштейн	Krzyżak
	Piastrina doppia	Cruz dupla	Двухместный кронштейн	Krzyżak

	ESPAÑOL	ENGLISH	FRANÇAIS	DEUTSCH
	Llave	Key	Clé	Schlüssel
	Kit solar	Solar kit	Kit solaire	Solar-kit
	Bit	Bit	Bit	Bit
	CE	CE	CE	CE
	Interior	Indoor	Intérieur	Interno
	Interactivo	Interactive	Interactif	Interattivo
	Nº leds / punto	No. LEDs / point	Nbr de LED / point lumineux	Nº leds / punto
	Exterior	Outdoor	Extérieur	Esterno
	Nº Leds / m²	No. of LEDs / m²	Nbr de LED / m²	Nº di Leds / m²
	Composición pixel	Pixel composition	Composition du pixel	Composizione pixel
	Distancia entre pixeles	Distance between pixels (in mm)	Distance entre pixels en mm	Distanza tra pixel mm
	Composición pixel	Pixel composition	Composition du pixel	Composizione pixel
	Potencia consumo máxima / m²	Maximum input power / m²	Puissance de consommation maximale / m²	Potenza consumo massima / m²
	Distancia de visión recomendada	Recommended viewing distance	Distance de vision conseillée	Distanza di visione consigliata
	Ángulo de visión horizontal	Horizontal viewing angle	Angle de vue horizontal	Angolo di visione orizzontale
	Ángulo de visión vertical	Vertical viewing angle	Angle de vue vertical	Angolo di visione verticale
	Peso / 50 puntos led	Weight / 50 LED points	Poids / 50 points LED	Peso / 50 punti led
	Peso	Weight	Poids	Peso
	Peso estático máximo	Maximum static weight	Poids statique maximum	Peso statico massimo
	IP frontal	Front IP	IP frontal	IP anteriore
	IP posterior	Back IP	IP postérieur	IP Posteriore
	Brillo	Brightness	Brillant	Lucentezza
	Escala de grises	Grey scale	Niveaux de gris	Scala di grigi
	Megahercios de la pantalla	Screen megahertz	Mégahertz de l'abat-jour	Megahertz dello schermo
	Colores	Colours	Couleurs	Colori
	Temperatura de trabajo	Working temperature	Température de fonctionnement	Temperatura di funzionamento
	Humedad de trabajo	Working humidity	Humidité de fonctionnement	Umidità di funzionamento
	Horas de vida	Life (in hours)	Durée de vie en heures	Ore di vita
	Alimentación	Power supply	Alimentation	Alimentazione
	Frecuencia alimentación	Supply frequency	Fréquence d'alimentation	Frequenza alimentazione









	ITALIANO	PORTUGUÊS	РУССКИЙ ЯЗЫК	POLSKI
	Chiave	Chave	Ключ	Klucz
	Kit solare	Kit solar	комплект солнечных элементов	Zestaw solar
	Bit	Bit	Bit	Bit
	CE	CE	CE	CE
	Interno	Interior	Для внутреннего освещения	Wewnętrzny
	Interattivo	Interativo	интерактивный	podłoga interaktywna
	N° leds / punto	N° de leds/ponto	Количество светодиодов на пиксель	Ilość LED/punkt
	Esterno	Exterior	Для внешнего освещения	Zewnętrzny
	N° di Leds / m2	N° de Leds / m ²	Количество светодиодов на м2	Liczba diod LED na m2
	Composizione pixel	Composição do pixel	Состав пикселя	Skład pikseli
	Distanza tra pixel mm	Distância entre pixels mm	Расстояние между пикселями, мм	Odległość pomiędzy pikselami (w mm)
	Composizione pixel	Composição do pixel	Состав пикселя	Skład pikseli
	Potenza consumo massima / m2	Potência de consumo máxima / m ²	Максимальная потребляемая мощность / м2	Maksymalna moc wejściowa na m2
	Distanza di visione consigliata	Distância de visão recomendada	Рекомендуемое расстояние зрительного восприятия	Rekomendowana odległość oglądania
	Angolo di visione orizzontale	Ângulo de visão horizontal	Горизонтальный угол изображения	Kąt patrzenia poziomy
	Angolo di visione verticale	Ângulo de visão vertical	Вертикальный угол изображения	Kąt patrzenia pionowy
	Peso / 50 punti led	Peso/50 pontos de LED	Вес	Waga na 50 punktów LED
	Peso	Peso	Максимальный статический вес	Waga
	Peso statico massimo	Peso estático máximo	Вес 50 светодиодов	Maksymalna waga statyczna
	IP anteriore	IP frontal	IP спереди	Przednie IP
	IP Posteriore	IP posterior	IP сзади	Tylne IP
	Lucentezza	Brilho	Яркость	Jasność
	Scala dei grigi	Escala de cinza	Шкала серого	Skala szarości
	Megahertz dello schermo	Megahertz da tela	Мегагерцы экрана	Częstotliwość odświeżania ekranu
	Colori	Cores	Цвета	Kolory
	Temperatura di funzionamento	Temperatura de trabalho	Рабочая температура	Temperatura pracy
	Umidità di funzionamento	Umidade de trabalho	Рабочая влажность	Wilgotność pracy
	Ore di vita	Horas de vida	Срок службы в часах	Żywotność (w godzinach)
	Alimentazione	Alimentação	Питание	Zasilanie
	Frequenza alimentazione	Frequência de alimentação	Частота питания	Częstotliwość wejściow

	ESPAÑOL	ENGLISH	FRANÇAIS	DEUTSCH
	PLÁSTICO ABS	ABS PLASTIC	PLASTIQUE ABS	SPRITZKUNSTSTOFF ABS
	ACRÍLICO	ACRYLIC	ACRYLIQUE	ACRYL
	ALUMINIO	ALUMINIUM	ALUMINIUM	ALUMINIUM
	ALUMINIO ANODIZADO	ANODIZED ALUMINIUM	ALUMINIUM ANODISÉ	ELOXIERTES ALUMINIUM
	ALUMINIO EXTRUSIONADO	EXTRUDED ALUMINIUM	EXTRUDÉ D'ALUMINIUM	EXTRUDIERTES ALUMINIUM
	ALUMINIO INYECTADO	INJECTED ALUMINIUM	ALUMINIUM INJECTÉ	SPRITZALUMINIUM
	ALUMINIO DE ALTA PUREZA	HIGH PURITY ALUMINUM	ALUMINIUM HAUTE PURETÉ	ALUMINIUM MIT HOHEM REINHEITSGRAD
	LATÓN PULIDO	POLISH BRASS	LAITON POLI	MESSING POLIERT
	ALGODÓN	COTTON	COTON	BAUMWOLLE
	MATIZADO	MATTE	MAT	MATTIERT
	CRISTAL	GLASS	VERRE	GLAS
	CRISTAL BISELADO Y SATINADO	BEVELED AND SATIN GLASS	VERRE BISEAUTÉ ET SATINÉ	GESCHLIFFENER UND SANTINIERTER GLAS
	CRISTAL BISELADO	BEVELED GLASS	VERRE BISEAUTÉ	GESCHLIFFENER GLAS
	CRISTAL BURBUJA	BUBBLED GLASS	VERRE À BULLES	BLÄSCHEN IM GLAS
	CRISTAL DECORADO	DECORATED GLASS	VERRE DÉCORÉ	DEKORIERTES GLAS
	CRISTAL GLASEADO	FROSTED GLASS	VERRE GIVRÉ	SATINIERTES GLAS
	CRISTAL TEMPLADO	HARDENED GLASS	VERRE TREMPÉ	GEHÄRTETES DURCHSICHTIGES GLAS
	CRISTAL SATINADO	SATIN GLASS	VERRE SATINÉ	GLAS SATINIERT
	CRISTAL LUPA	MAGNIFYNG GLASS	VERRE DE LOUPE	LUPENGLAS
	CRISTAL MATE	MATT GLASS	VERRE MAT	MATTER GLAS
	CRISTAL OPAL	OPAL GLASS	VERRE OPAL	OPTISCHES GLAS
	CRISTAL RÚSTICO	RUSTIC GLASS	VERRE RUSTIQUE	RUSTIKALER MIT BLÄSCHEN IM GLAS
	CRISTAL TRANSPARENTE	TRANSPARENT GLASS	VERRE TRANSPARENT	TRANSPARENTER GLAS
	CRISTAL EXTRA BLANCO	EXTRA WHITE GLASS	VERRE EXTRA BLANC	GLAS EXTRA WEISS
	POLIETILENO DE ALTA DENSIDAD	HIGH DENSITY POLYTHYLENE	POLYÉTHYLÈNE HAUTE DENSITÉ	HOCHDICHTER POLYETHEN
	ACERO INOXIDABLE AISI 202	STAINLESS STEEL AISI 202	ACIER INOXYDABLE AISI 202	ROSTFREIER STAHL AISI 202
	ACERO INOXIDABLE AISI 304	STAINLESS STEEL AISI 304	ACIER INOXYDABLE AISI 304	ROSTFREIER STAHL AISI 304

	ITALIANO	PORTUGUÊS	РУССКИЙ ЯЗЫК	POLSKI
	PLASTICA ABS	PLÁSTICO ABS	ABS ПЛАСТИК	PLASTIK ABS
	ACRILICO	ACRILICO	АКРИЛОВЫЙ	AKRYLOWY
	ALLUMINIO	ALUMINIO	АЛЮМИНИЙ	ALUMINIUM
	ALLUMINIO ANODIZZATO	ALUMINIO ANODIZADO	АНОДИРОВАННЫЙ АЛЮМИНИЙ	ALUMINIUM ANODOWANE
	ESTRUSO DI ALUMINIO	ALUMÍNIO EXTRUDIDO	ПРЕССОВАННЫЙ АЛЮМИНИЙ	WYCISKANE ALUMINIUM
	ALLUMINIO PRESSOFUSO	ALUMÍNIO INJECTADO	ИНЖЕКТИРОВАННЫЙ АЛЮМИНИЙ	WTRYSKIWANE ALUMINIUM
	ALLUMINIO DI ALTA PUREZZA	ALUMÍNIO DE ELEVADA PUREZA	АЛЮМИНИЙ ВЫСОКОЙ ЧИСТОТЫ	ALUMINIUM WYSOKIEJ CZYSTOŚCI
	OTTONE LEVIGATO	LATÃO POLIDO	ПОЛИРОВАННАЯ ЛАТУНЬ	MOSIADZ POLEROWANY
	COTONE	ALGODÃO	ХЛОПОК	BAWEŁNA
	SFUMATO	MATIZADO	ПОЛЯРИЗОВАННЫЙ	MAT
	VETRO	VIDRO	СТЕКЛО	SZKŁO
	VETRO MOLATO SATINADO	VIDRO SATINADO COM MOLDURA FACETADA	ФАЦЕТИРОВАННОЕ И САТИНИРОВАННОЕ СТЕКЛО	SZKŁO FAZOWANE SATYNOWE
	VETRO BISELATTO	VIDRO COM MOLDURA FACETADA	ФАЦЕТИРОВАННОЕ СТЕКЛО	SZKŁO FAZOWANE
	VETRO BOLICOSO	VIDRO COM BOLHAS	ПУЗЫРЯЩЕЕСЯ СЕКЛО	SZKŁO Z PĘCZERZYKAMI
	CRISTALLO DECORATO	VIDRIO DECORADO	ДЕКОРАТИВНОЕ СТЕКЛО	SZKŁO DEKOROWANE
	VETRO SATINATO	VIDRO POLIDO	МАТОВОЕ	SZKŁO SZRONIONE
	VETRO INDURITO	VIDRO ENDURECIDO	ЗАКАЛЁННОЕ СТЕКЛО	SZKŁO HARTOWANE
	VETRO SATINATO	VIDRO ACETINADO	СТЕКЛО САТИНОВОЕ	SZKŁO SATYNOWE
	VETRO CON LENTE EFFETTO DIFFONDENTE	VIDRO TIPO LUPA	УВЕЛИЧИТЕЛЬНОЕ СТЕКЛО	SZKŁO POWIĘKSZAJĄCE
	VETRO MATTIZZATO	VIDRO MATE	МАТОВОЕ СЕКЛО	MATOWE SZKŁO
	VETRO OTTICO	VIDRO OPALINO	МАТОВОЕ СТЕКЛО	SZKŁO MLECZNE
	VETRO RUSTICO	VIDRO RÚSTICO	ГРУБОЕ СТЕКЛО	SZKŁO RUSTYKALNE
	VETRO TRANSPARENTE	VIDRIO TRANSPARENTE	ПРОЗРАЧНОЕ СТЕКЛО	PRZEZROCZYSTE SZKŁO
	VETRO EXTRA BIANCO	VIDRO EXTRA BRANCO	ДОПОЛНИТЕЛЬНЫХ БЕЛОГО СТЕКЛА	EXTRA BIAŁE SZKŁO
	POLIETILENO AD ALTA DENISTA	POLIETILENO DE ALTA DENSIDADE	ПОЛИЭТИЛЕН ВЫСОКОЙ ПЛОТНОСТИ	POLIETYLEN WYSOKIEJ GĘSTOŚCI
	ACCIAIO INOSSIDABILE AISI 202	AÇO INOXIDÁVEL AISI 202	НЕРЖАВЕЮЩАЯ СТАЛЬ AISI 202	STAL NIERDZEWNA AISI 202
	ACCIAIO INOSSIDABILE AISI 304	AÇO INOXIDÁVEL AISI 304	НЕРЖАВЕЮЩАЯ СТАЛЬ AISI 304	STAL NIERDZEWNA AISI 304

	ESPAÑOL	ENGLISH	FRANÇAIS	DEUTSCH
	ACERO INOXIDABLE AISI 316	STAINLESS STEEL AISI 316	ACIER INOXYDABLE AISI 316	ROSTFREIER STAHL AISI 316
	ESPEJO	MIRROR	MIROIR	SPIEGEL
	POLICARBONATO	POLYCARBONATE	POLYCARBONATE	POLYKARBONAT
	POLICARBONATO MATE	MATT POLYCARBONATE	POLYCARBONATE MAT	MATTER POLYKARBONAT
	POLICARBONATO OPAL	OPAL POLYCARBONATE	POLYCARBONATE OPALE	OPALER POLYKARBONAT
	POLICARBONATO PRISMATIZADO	PRISMATIC POLYCARBONATE	POLYCARBONATE PRISMATIQUE	PRISMATISIERTER POLYKARBONAT
	POLICARBONATO TRANSPARENTE	TRANSPARENT POLYCARBONATE	POLYCARBONATE TRANSPARENT	TRANSPARENTER POLYKARBONAT
	POLIETILENO	POLYTHYLENE	POLYÉTHYLÈNE	POLYÄTHYLEN
	PMMA	PMMA	PMMA	PMMA
	PMMA MATE	MATT PMMA	PMMA MAT	MATTER PMMA
	PMMA TRANSPARENTE	TRANSPARENT PMMA	PMMA TRANSPARENT	TRANSPARENTER PMMA
	PMMA OPAL MATE	SATIN OPAL PMMA	PMMA OPALE SATINÉ	OPAL MATTER PMMA
	PMMA PRISMATIZADO	PRISMATIC PMMA	PMMA PRISMATIQUE	PRISMATISIERTER PMMA
	ALGODÓN PLASTIFICADO	PLASTICIZED COTTON	COTON PLASTIFIÉ	BAUMWOLLE
	CONTRACHAPADO	PLYWOOD	CONTREPLAQUÉ	SPERRHOLZ
	YESO	PLASTER	GYPSE	VERPUTZ
	POLIPROPILENO	POLYPROPYLENE	POLYPROPYLÈNE	POLYPROPYLEN
	PLÁSTICO MATE	MATT PLASTIC	PLASTIQUE MAT	KUNSTSTOFF SCHATTIERT
	POLIURETANO	POLYURETHANE	POLYURÉTHANE	POLYURETHAN
	PVC	PVC	PVC	PVC
	RESINA	RESIN	RÉSINE	HARZ
	SILICONA	SILICONE	SILICONE	SILIKON
	SEDA	SILK	SOIE	SEIDE
	CRISTAL AHUMADO	SMOKED GLASS	VERRE FUMÉ	RAUCHGLAS
	ACERO	STEEL	ACIER	STAHL
	ACERO FUNDIDO	CAST STEEL	ACIER COULÉ	GUSSSTAHL
	ACERO ACABADO EPOXY	EPOXY FINISH STEEL	ACIER FINITION EXPOSI	STAHL, FERTIGVERARBEITUNG MIT EPOXY-LACKIERUNG



























	ITALIANO	PORTUGUÊS	РУССКИЙ ЯЗЫК	POLSKI
	ACCIAIO INOSSIDABILE AISI 316	AÇO INOXIDÁVEL AISI 316	НЕРЖАВЕЮЩАЯ СТАЛЬ	STAL NIERDZEWNA AISI 316
	SPECCHIO	ESPELHO	ЗЕРКАЛО	LUSTRO
	POLICARBONATO	POLICARBONATO	ПОЛИКАРБОНАТ	POLIWEGLANOWY
	POLICARBONATO MATTIZZATO	POLICARBONATO MATE	МАТОВЫЙ ПОЛИКАРБОНАТ	MATOWY POLIWEGLAN
	POLICARBONATO OPALE	POLICARBONATO OPALINO	ОПАЛЬНЫЙ ПОЛИКАРБОНАТ	OPALIZOWANY POLIWEGLAN
	POLICARBONATO PRISMATICO	POLICARBONATO PRISMÁTICO	ПРИЗМАТИЧЕСКИЙ ПОЛИКАРБОНАТ	PRYZMATYCZNY POLIWEGLAN
	POLICARBONATO TRASPARENTE	POLICARBONATO TRANSPARENTE	ПРОЗРАЧНЫЙ ПОЛИКАРБОНАТ	PRZEZROCZYSTY POLIWEGLAN
	POLIETILENE	POLIETILENO	ПОЛИЭТИЛЕН	POLIETYLEN
	PMMA	PMMA	PMMA	PMMA
	PMMA MATTIZZATO	PMMA MATE	МАТОВЫЙ PMMA	MATOWY PMMA
	PMMA TRASPARENTE	PMMA TRASPARENTE	ПРОЗРАЧНЫЙ PMMA	PRZEZROCZYSTY PMMA
	PMMA OPALE MATIZZATO	PMMA OPALINO SATINADO	РАСSEИВАЮЩЕЕ PMMA ОПАЛОВОЕ	SATYNOWY OPALIZOWANY PMMA
	PMMA PRISMATICO	PMMA PRISMÁTICO	ПРИЗМАТИЧЕСКОЕ СТЕКЛО	PRYZMATYCZNY PMMA
	COTONE PLASTIFICATO	ALGODAO PLASTIFICADO	УПЛОТНЕННЫЙ ХЛОПОК	POWLEKANA BAWĘLNA
	COMPENSATO	CONTRAPLACADO	ФАНЕРА	SKLEJKA
	GESSO	GESSO	ГИПС	GIPS
	POLIPROPILENE	POLIPROPILENO	ПОЛИПРОПИЛЕН	POLIPROPYLEN
	PLASTICA SFUMATA	PLÁSTICO FOSCO	МАТОВЫЙ ПЛАСТИК	MATOWE TWORZYWO SZTUCZNE
	POLIURETANO	POLIURETANO	ПОУЛИРИТАН	POLIURETAN
	PVC	PVC	PVC	PVC
	RESINA	RESINA SINTÉTICA	РЕЗИНА	ŻYWICA
	SILICONE	SILICONE	СИЛИКОН	SILIKON
	SETA	SEDA	ШЕЛК	JEDWAB
	VETRO FUMÉ	VIDRO FUMÉ	ДЫМЧАТОЕ СТЕКЛО	SZKŁO DYMIONE
	ACCIAIO	AÇO	СТАЛЬ	STALOWY
	ACCIAIO FUSO	AÇO FUNDIDO	ЛИТАЯ СТАЛЬ	STAL PRASOWANA
	ACCIAIO ALLUMINIO PRESSOFUSO	AÇO COM ACABAMENTO EPOXY	ЭПОКСИДНОЕ ПОКРЫТИЕ СТАЛИ	STAL WYKOŃCZONA EPOKSYDOWO

	ESPAÑOL	ENGLISH	FRANÇAIS	DEUTSCH
	TECNOPOLÍMERO	TECHNOPOLYMER	TECHNOPOLYMÈRE	TECHNOPOLYMER
	TERMOPLÁSTICO	THERMOPLASTIC	THERMOPLASTIQUE	THERMOPLASTIK
	PROTECCIÓN UVA	UVA PROTECTION	PROTECTION UVA	AL:UV-SCHUTZ
	CRISTAL UVA	UVA GLASS	VERRE UV.	UVA GLAS
	MADERA	WOOD	BOIS	HOLZ
	ZAMAK	ZAMAK	ZAMAK	ZAMAK
	MATERIAL DIFUSOR	DIFFUSER MATERIAL	MATÉRIAU DIFFUSEUR	MATERIAL DIFFR
	MATERIAL PANTALLA	SHADE MATERIAL	MATÉRIAU ABAT-JOUR	MATERIAL DES SCHIRMES
	MATERIAL PALAS	BLADES MATERIAL	MATÉRIAU PALE	MATERIAL DES FLÜGELS







	ESPAÑOL	ENGLISH	FRANÇAIS	DEUTSCH
	NEGRO	BLACK	NOIR	SCHWARZ
	NARANJA	ORANGE	ORANGE	ORANGE
	AZUL	BLUE	BLEU	BLAU
	BLANCO	WHITE	BLANC	WEISS
	BLANCO ANTIGUO	OLD WHITE	BLANC ANCIEN	ALT WEISS
	MARRÓN ÓXIDO	RUSTY BROWN	MARRON ROUILLÉ	BRAUNROST
	BEIGE	BEIGE	BEIGE	BEIGE
	CROMO	CHROME	CHROME	CHROM
	LATÓN PULIDO	POLISH BRASS	LAITON POLI	MESSING POLIERT
	ROJO	RED	ROUGE	ROT
	GRIS	GREY	GRIS	GRAU
	TRANSPARENTE	TRANSPARENT	TRANSPARENT	DURCHSICHTIG
	ACERO CINCADO	ZINC PLATED STEEL	ACIER ZINGUÉ	VERZINKTER STAHL

	ITALIANO	PORTUGUÊS	РУССКИЙ ЯЗЫК	POLSKI
	TECNOPOLIMERO	TECNOPOLÍMERO	ТЕХНОПОЛИМЕР	TECHNOPOLIMER
	TERMOPLASTICA	THERMOPLÁSTICO	ТЕРМОПЛАСТИК	TERMOPLASTYCZNY
	PROTEZIONE RAGGI UVA	PROTEÇÃO UVA	ЗАЩИТА ОТ УФЛ	OCHRONA UVA
	VETRO UVA	VIDRO UVA	СТЕКЛО С ЗАЩИТОЙ ОТ УЛЬТРАФИОЛЕТОВЫХ ЛУЧЕЙ	SZKŁO UVA
	LEGNO	MADEIRA	ДЕРЕВО	DREWNO
	ZAMAK	ZAMAK	ZAMAK	ZAMAK
	MATERIALE DEL DIFFUSORE	MATERIAL DIFUSOR	МАТЕРИАЛ РАССЕЙВАТЕЛЯ	MATERIAŁ ROZPRASZAJĄCY
	MATERIALE DEL PARALUME	MATERIAL ABAJUR	МАТЕРИАЛ АБАЖУРА	MATERIAŁ ABAŻURU
	MATERIALE DELLE PALE	MATERIAL PÁS	МАТЕРИАЛ ЛОПАСТИ	MATERIAŁ ŚMIGŁA

	ITALIANO	PORTUGUÊS	РУССКИЙ ЯЗЫК	POLSKI
	NERO	PRETO	ЧЕРНЫЙ	CZARNY
	ARANCIONE	LARANJA	ОРАНЖЕВЫЙ	POMARANCZOWY
	BLU	AZUL	СИНИЙ	NIEBIESKI
	BIANCO	BRANCO	БЕЛИЛА	BIAŁY
	BIANCO ANTICHIZZATO	BRANCO VELHO	СТАРИННЫЙ БЕЛЫЙ	STARY BIAŁY
	MARRONE OSSIDATO	MARROM ÓXIDO	РЖАВО-КОРИЧНЕВЫЙ	RDZAWY BRAZ
	BEIGE	BEGE	БЕЖЕВЫЙ	BEZ
	CROMO	CROMO	ХРОМ	CHROMOWANY
	OTTONE LEVIGATO	LATÃO POLIDO	ПОЛИРОВАННАЯ ЛАТУНЬ	MOSIADZ POLEROWANY
	ROSSO	VERMELHO	КРАСНЫЙ	CZERWONY
	GRIGIO	CINZENTO	СЕРЫЙ	SZARY
	TRASPARENTE	TRANSPARENTE	ПРОЗРАЧНЫЙ	PRZEZROCZYSTE
	ACCIAIO ZINCATO	AÇO ZINCADO	ОЦИНКОВАННАЯ СТАЛЬ	OCYNKOWANA STAL

	ESPAÑOL	ENGLISH	FRANÇAIS	DEUTSCH
 54	ALUMINIO ANODIZADO	ANODIZED ALUMINIUM	ALUMINIUM ANODISÉ	ALUMINIUM ELOXIERT
 81 NS	NÍQUEL SATINADO	SATIN NICKEL	NICKEL SATINÉ	NICKEL SATINIERT
 AJ	GRIS ÓPERA	OPERA GREY	GRIS OPÉRA	OPERA GRAU
 AL AW	ALUMINIO	ALUMINIUM	ALUMINIUM	ALUMINIUM
 AT	GRIS RAL 7035	GREY RAL 7035	GRIS RAL 7035	GRAU RAL 7035
 AU	GRIS RAL 9006	GREY RAL 9006	GRIS RAL 9006	GRAU RAL 9006
 AV	ACERO GALVANIZADO	GALVANISED STEEL	ACIER GALVANISÉ	GALVANISIERTES STAHL
 AS	NEGRO BRILLANTE / BLANCO BRILLANTE / CROMO	SHINY BLACK / SHINY WHITE / CHROME	NOIR BRILLANT / BLANC BRILLANT / CHROME	SCHWARZ GLÄNZEND / WEISS GLÄNZEND / CHROM
 BB	CABEZAL EN GRIS (AU) + COLUMNA EN NEGRO (BP)	HEAD IN GREY (AU) + COLUMN IN BLACK (BP)	TÊTE EN GRIS (AU) + MÂT EN NOIR (BP)	KOPFSTÜCK IN GRAU (AU) + SÄULE IN SCHWARZ (BP)
 BK	ANODIZADO	ANODIZED	ANODISÉ	ELOXIERT
 BP	NEGRO (PINTURA EN POLVO)	BLACK (POWDER PAINT)	NOIR (PEINTURE EN POUDRE)	SCHWARZ (PULVERLACK)
 BQ	GRIS URBANO	URBAN GREY	GRIS URBAIN	ANTHRAZIT
 BS	GRIS RAL 9007	GREY RAL 9007	GRIS RAL 9007	GRAU RAL 9007
 BX	ALUMINIO CEPILLADO	BRUSHED ALUMINIUM	ALUMINIUM BROSSÉ	ALUMINIUM GEBÜRSTET
 BY	ARENA	BEIGE FABRIC	BEIGE	SANDFARBE
 CA	ACERO INOXIDABLE AISI 316	STAINLESS STEEL AISI 316	ACIER INOXYDABLE AISI 316	ROSTFREIER STAHL AISI 316
 CC	GRIS ENVEJECIDO	OLD GREY	GRIS VIEILLI	ALT GRAU
 CF	BLANCO BRILLANTE	BRIGHT WHITE	BLANC BRILLANT	WEISS GLÄNZEND
 D8	PAN DE ORO	GOLDEN LEAF	FEUILLE D'OR	BLATTGOLD
 D9	PAN DE PLATA	SILVER LEAF	FEUILLE D'ARGENT	BLATTSILBER
 E2	ORO VIEJO	OLD GOLD	OR VIEILLI	ALTGOLD
 E4	PATINÉ	ANTIQUE BRASS	PATINÉ	ALTMESSING
 J2	ANODIZADO PLATA	ANODIZED SILVER	ARGENT ANODISÉ	SILBER ELOXIERT
 J6	MARRÓN	BROWN	MARRON	BRAUN
 J7	MARRÓN COBRIZO	COPPER BROWN	MARRON CUIVRÉ	KUPFERROT BRAUN
 K7	GRIS PIEDRA	STONE GREY	GRIS PIERRE	STEINGRAU
 S2	ALUMINIO SATINADO	SATIN ALUMINIUM	ALUMINIUM SATINÉ	ALUMINIUM MATT

	ITALIANO	PORTUGUÊS	РУССКИЙ ЯЗЫК	POLSKI
	ALLUMINIO ANODIZZATO	ALUMINIO ANODIZADO	АНОДИРОВАННЫЙ АЛЮМИНИЙ	ALUMINIUM ANODOWANE
	NÍCHEL SATINATO	NÍQUEL ACETINADO	САТИНОВЫЙ НИКЕЛЬ	SZCZOTKOWANY NIKIEL
	GRIGIO	GRIS OPERA	АБАЖУР СЕРЕБРЯНЫЙ ШЕЛК	OPERA SZARY
	ALLUMINIO	ALUMINIO	АЛЮМИНИЙ	ALUMINIUM
	GRIGIO RAL 7035	CINZENTO RAL 7035	СЕРЫЙ RAL 7035	SZARY RAL 7035
	GRIGIO RAL 9006	CINZENTO RAL 9006	СЕРЫЙ RAL 9006	SZARY RAL 9006
	ACCIAIO GALVANIZZAT	AÇO GALVANIZADO	ОЦИНКОВАННАЯ СТАЛЬ	STAL GALWANIZOWANA
	NERO BRILLANTE / BIANCO BRILLANTE / CROMO	PRETO BRILHANTE / BRANCO BRILHANTE / CROMO	ЧЕРНЫЙ БЛЕСТЯЩИЙ / БЕЛЫЙ БЛЕСТЯЩИЙ / ХРОМ	LSNIACY CZARNY/LSNIACY BIAŁY/ CHROMOWANY
	TESTATA IN GRIGIO (AU) + COLONNA IN NERO	CABEÇA EM CINZENTO (AU) + COLUNA EM PRETO (BP)	ГОЛОВКА СЕРОГО ЦВЕТА (AU) + КОЛОННА ЧЕРНОГО ЦВЕТА (BP)	GŁOWICA W SZAROŚCI (AU) + SŁUP W CZERNI (BP)
	ANODIZZATO	ANODIZADO	АНОДИРОВАННЫЙ	ANODOWANY
	NERO (VERNICE IN POLVERE)	PRETO (PINTURA EM PÓ)	ЧЕРНЫЙ (ПОРОШОК)	CZARNY (FARBA PROSZKOWA)
	GRIGIO URBANO	CINZENTO URBANO	ГОРОДСКОЙ СЕРЫЙ	MIEJSKI SZARY
	GRIGIO RAL 9007	CINZENTO RAL 9007	СЕРЫЙ RAL 9007	SZARY RAL 9007
	ALLUMINIO SPAZZOLATO	ALUMÍNIO ESCOVADO	МАТОВЫЙ АЛЮМИНИЙ	SZCZOTKOWANE ALUMINIUM
	SABBIA	AREIA	ПЕСОЧНЫЙ	BEZ
	ACCIAIO INOSSIDABILE AISI 316	AÇO INOXIDÁVEL AISI 316	НЕРЖАВЕЮЩАЯ СТАЛЬ	STAL NIERDZEWNA AISI 316
	GRIGIO ANTICO	CINZA ENVELHECIDO	СЕРЫЙ АНТИЧНЫЙ	STARY SZARY
	BIANCO LUCIDO	BRANCO BRILLANTE	БЕЛЫЙ БЛЕСТЯЩИЙ	JASNY BIAŁY
	FOGLIA DI ORO	CAPA DE OURO	СУСАЛЬНОЕ ЗОЛОТО	ZŁOTO PŁATKOWE
	FOGLIA ARGENTO	CAPA DE PRATA	СУСАЛЬНОЕ СЕРЕБРО	SREBRO PŁATKOWE
	ORO ANTICO	VELHO	СТАРОЕ ЗОЛОТО	STARE ZŁOTO
	PATINATO	PATINADO	ПАТИНЕ	MOSIADZ ANTYCZNY
	ARGENTO ANODIZZATO	ANODIZADO PRATA	АНОДИРОВАННЫЙ СЕРЕБРИСТЫЙ	ANODOWANY SREBRNY
	MARRONE	MARROM	КОРИЧНЕВЫЙ	BRAZOWY
	MARRONE COLOR RAME	MARROM ACOBREADO	КОРИЧНЕВАЯ МЕДЬ	MIEDZIOWY BRAZ
	GRIGIO PIETRA	CINZENTO PEDRA	СЕРЫЙ КАМЕНЬ	SZARY KAMIEŃ
	ALLUMINIO SATINATO	ALUMÍNIO ACETINADO	САТИНОВЫЙ АЛЮМИНИЙ	ALUMINIUM SATYNOWE

	ESPAÑOL	ENGLISH	FRANÇAIS	DEUTSCH
 S2	ALUMINIO CEPILLADO	BRUSHED ALUMINIUM	ALUMINIUM BROSSÉ	ALUMINIUM GEBÜRSTET
 S4	ÁMBAR DORADO	GOLDEN AMBER	AMBRÉ DORÉ	BERNSTEINFARBIGES GOLD
 T001	TRAMADO BEIGE	PERFORATED BEIGE	PERFORÉ BEIGE	GEWIRKT BEIGE
 T4	PLATA RÚSTICA	RUSTIC SILVER	ARGENT RUSTIQUE	RUSTIKALES SILBER
 V7	COBRE VIEJO	OLD COPPER	CUIVRE VIEUX	ALTES KUPFER
 Y2	MARRÓN ENVEJECIDO	OLD BROWN	MARRON VIEILLI	ALTBRAUN
 Y4	ACERO INOXIDABLE AISI 202/304	STAINLESS STEEL AISI 202/304	ACIER INOXYDABLE AISI 202/304	ROSTFREIER STAHL AISI 202/304
 Z5	GRIS URBANO	URBAN GREY	GRIS URBAIN	ANTHRAZIT

	ITALIANO	PORTUGUÊS	РУССКИЙ ЯЗЫК	POLSKI
	ALLUMINIO SPAZZOLATO	ALUMÍNIO ESCOVADO	МАТОВЫЙ АЛЮМИНИЙ	SZCZOTKOWANE ALUMINIUM
	AMBRA DORATO	ÂMBAR DOURADO	ПОЗОЛОЧЕННЫЙ ЯНТАРЬ	ZŁOTY BURSZTYN
	TRAMATURA BEIGE	PERFURADO BEGE	БЕЖЕВЫЙ СЕТИ	BEŻOWY PERFOROWANY
	ARGENTO RUSTICO	PRATA RÚSTICA	НЕОБРАБОТАННОЕ СЕРЕБРО	RUSTYKALNE SREBRO
	RAME ANTICATO	COBRE VELHO	СТАРАЯ МЕДЬ	STARA MIEDZ
	MARRONE ANTICHIZZATO	CASTANHO ENVELHECIDO	БРАУН АНТИК	STARY BRĄZOWY
	ACCIAIO INOSSIDABILE AISI 202/304	AÇO INOXIDÁVEL AISI 202/304	НЕРЖАВЕЮЩАЯ СТАЛЬ AISI 202/304	STAL NIERDZEWNA AISI 202/304
	GRIGIO URBANO	CINZENTO URBANO	ГОРОДСКОЙ СЕРЫЙ	SZARY MIEJSKI

Reference	Page
00-0073-14-05	236
00-0240-21-16	247
00-0240-21-Z5	247
00-0253-21-16	246
00-0253-S4-CC	246
00-0264-21-82	256
00-0268-21-82	256
00-1509-14-21	237
00-1640-81-F9	239
00-1799-21-16	244
00-1799-S4-CG	244
00-2011-21-16	245
00-2011-S4-CG	245
00-2017-14-14	226
00-2018-14-F9	238
00-2018-21-F9	238
00-2287-14-14	226
00-2689-S2-00	185
00-2708-16-11	240
00-2708-CG-16	240
00-2709-16-11	240
00-2709-CG-16	240
00-2710-16-11	240
00-2710-CG-16	240
00-2713-81-AJ	263
00-2749-E2-16	242
00-2749-T4-11	242
00-2785-21-AS	254
00-2908-E2-16	242
00-2908-T4-11	242
00-3219-S2-M2	232
00-3251-14-M1	228
00-3272-S2-37	230
00-3279-05-05	234
00-3279-16-16	234
00-3280-05-05	235
00-3280-05-16	235
00-3280-16-16	235
00-4339-21-05	260
00-4341-Z6-20	267
00-4343-05-05	250
00-4343-14-14	250
00-4426-14-14	250
00-9151-18-E7	613
00-9295-18-M3	611
00-9298-14-M1	609
00-9298-Z5-M3	609
00-9350-18-AA	611
00-9522-18-M3	611
00-9669-14-M1	609
00-9742-Z5-M1	609
00-9785-18-AA	613
05-0026-21-F9	422
05-0027-21-F9	422
05-0028-21-F9	422
05-0069-14-14	359
05-0070-14-14	360
05-0070-S2-14	360
05-0071-14-14	359
05-0072-34-34	344
05-0392-21-14	397
05-0392-21-25	397
05-0486-14-M1	346
05-0487-05-54	362

Reference	Page
05-0487-14-54	362
05-0517-21-E9	370
05-0518-21-E9	370
05-0519-21-E9	370
05-0530-21-E9	370
05-0533-14-14	359
05-0534-14-14	360
05-0575-Y2-E7	271
05-0576-Y2-E7	271
05-0848-16-21	376
05-0849-16-21	376
05-0850-16-21	376
05-1136-16-82	320
05-1380-21-F9	425
05-1383-21-F9	425
05-1389-21-F9	425
05-1410-21-F9	425
05-1411-21-F9	424
05-1507-21-M1	418
05-1508-21-M1	418
05-1513-21-21	378
05-1514-21-21	378
05-1530-21-05	394
05-1530-21-14	394
05-1531-21-05	394
05-1531-21-14	394
05-1544-54-H6	497
05-1546-54-H6	497
05-1547-54-H6	497
05-1548-54-H6	497
05-1549-54-H6	497
05-1552-54-H6	497
05-1555-34-34	343
05-1566-81-82	328
05-1567-81-82	314
05-1577-21-M2	352
05-1577-81-M2	352
05-1577-E4-M2	352
05-1611-21-M2	352
05-1611-81-M2	352
05-1611-E4-M2	352
05-1613-14-00	199
05-1613-N3-00	199
05-1618-14-00	199
05-1618-N3-00	199
05-1709-14-00	199
05-1709-N3-00	199
05-1719-14-00	199
05-1719-N3-00	199
05-1793-14-14	364
05-1794-14-14	363
05-1795-14-14	364
05-1796-14-14	364
05-1798-14-14	363
05-1798-D8-D8	363
05-1798-D9-D9	363
05-1804-14-00	203
05-1808-14-00	203
05-2015-14-14	342
05-2015-34-34	342
05-2017-14-14	226
05-2019-14-14	360
05-2019-S2-14	360
05-2233-14-14	356

Reference	Page
05-2304-S4-15	270
05-2325-21-M1	416
05-2326-21-M1	416
05-2327-21-M1	418
05-2328-21-M1	418
05-2494-54-H6	503
05-2498-54-H6	503
05-2499-54-H6	503
05-2510-Z6-82	332
05-2703-14-14	354
05-2703-21-21	354
05-2703-81-81	354
05-2704-14-14	354
05-2704-21-21	354
05-2704-81-81	354
05-2705-14-14	354
05-2705-21-21	354
05-2705-81-81	354
05-2706-21-21	345
05-2706-81-81	345
05-2706-E4-E4	345
05-2707-81-21	255
05-2753-14-M2	350
05-2755-81-21	277
05-2756-81-21	278
05-2757-14-82	308
05-2758-14-82	308
05-2759-14-05	236
05-2775-21-14	341
05-2785-21-AS	254
05-2814-81-05	340
05-2814-81-14	340
05-2814-81-20	340
05-2815-81-81	282
05-2817-81-14	262
05-2820-21-21	281
05-2820-81-81	281
05-2825-21-82	305
05-2830-34-34	347
05-2831-34-34	347
05-2835-54-54	348
05-2837-21-21	348
05-2838-21-21	348
05-2840-21-82	296
05-2845-21-21	348
05-2897-21-M2	352
05-2897-81-M2	352
05-2897-E4-M2	352
05-2900-N3-XY	205
05-2904-14-00	203
05-3213-21-B4	430
05-3217-21-82	276
05-3217-81-82	276
05-3217-E4-82	276
05-3218-21-82	274
05-3218-81-82	274
05-3218-E4-82	274
05-3220-14-14	358
05-3220-25-25	358
05-3220-34-34	358
05-3251-14-M1	228
05-3307-S2-00	195
05-3308-S2-00	195
05-3314-N3-B9	195

Reference	Page
05-3358-N3-37	513
05-4339-21-05	261
05-4341-Z6-20	268
05-4343-05-05	252
05-4343-14-14	252
05-4351-21-37	377
05-4352-21-37	377
05-4357-21-M1	415
05-4358-21-M1	415
05-4361-21-05	413
05-4362-21-05	413
05-4363-81-20	341
05-4373-21-F9	428
05-4374-21-M1	416
05-4375-21-M1	416
05-4376-21-M1	416
05-4377-21-M1	418
05-4378-21-M1	418
05-4379-81-F9	424
05-4385-21-M1	420
05-4386-21-M1	420
05-4387-21-M1	420
05-4401-14-B8	366
05-4401-BX-B8	366
05-4402-BX-B8	367
05-4427-S2-M1	359
05-4695-81-82	286
05-4695-Y2-82	286
05-4696-81-82	284
05-4696-Y2-82	284
05-4697-81-82	283
05-4697-Y2-82	283
05-4698-21-M1	412
05-4699-21-M1	412
05-4700-21-M1	412
05-4713-N3-M3	209
05-4714-N3-M3	209
05-4715-N3-M3	209
05-8729-05-M3	569
05-8729-34-M3	569
05-8751-05-M3	569
05-8751-34-M3	569
05-8762-18-37	583
05-8790-Y4-M1	573
05-8796-Y4-M1	575
05-8959-05-37	591
05-8961-05-B8	619
05-8961-14-B8	619
05-8961-34-B8	619
05-9104-18-M2	591
05-9107-34-37	517
05-9107-Z5-37	517
05-9122-Y4-37	517
05-9123-34-B8	547
05-9123-Z5-B8	547
05-9124-18-37	589
05-9126-18-AA	587
05-9129-34-37	529
05-9129-Z5-37	529
05-9131-14-M3	547
05-9131-34-M3	547
05-9131-Z5-M3	547
05-9132-18-AA	591
05-9146-34-T2	549

Reference	Page
05-9149-18-AA	587
05-9151-18-E7	593
05-9152-18-E7	593
05-9158-18-AA	583
05-9159-Z5-37	529
05-9175-18-AA	593
05-9177-14-B8	367, 537
05-9177-34-B8	537
05-9177-J6-B8	537
05-9177-Z5-B8	537
05-9179-14-B8	619
05-9179-34-B8	619
05-9179-Z5-B8	619
05-9182-34-B8	627
05-9190-34-37	559
05-9191-34-37	559
05-9202-18-AA	589
05-9204-34-B8	549
05-9207-J6-M1	577
05-9207-Y4-M1	577
05-9211-CA-T2	621
05-9211-Y4-T2	621
05-9212-CA-T2	621
05-9212-Y4-T2	621
05-9227-34-37	533
05-9227-Z5-37	533
05-9228-14-37	533
05-9228-34-37	533
05-9228-Z5-37	533
05-9229-14-37	535
05-9229-34-37	535
05-9229-J6-37	535
05-9229-Z5-37	535
05-9230-14-37	535
05-9230-34-37	535
05-9230-J6-37	535
05-9230-Z5-37	535
05-9234-18-37	551
05-9234-34-37	551
05-9238-34-M3	571
05-9239-CA-M2	573
05-9245-CA-37	657
05-9251-34-37	501
05-9254-34-37	501
05-9264-Z5-37	499
05-9265-Z5-37	499
05-9266-Z5-37	499
05-9295-18-M3	591
05-9296-34-37	517
05-9296-Z5-37	517
05-9298-14-M1	581
05-9298-Z5-M3	581
05-9299-Z5-M3	581
05-9300-34-M3	567
05-9300-Z5-M3	567
05-9309-34-37	551
05-9310-CA-37	519
05-9315-34-B8	563
05-9315-Z5-B8	563
05-9327-34-37	517
05-9327-Z5-37	517
05-9330-05-B8	585
05-9331-05-B8	585

Reference	Page
05-9333-J6-M1	573
05-9344-34-T2	561
05-9344-J6-T2	561
05-9350-18-AA	589
05-9351-18-AA	583
05-9356-05-B8	585
05-9368-14-37	541
05-9368-34-37	541
05-9368-Z5-37	541
05-9369-34-37	541
05-9369-Z5-37	541
05-9373-J6-M3	583
05-9390-Z5-M3	581
05-9408-34-M3	525
05-9408-Z5-M3	525
05-9409-34-M3	547
05-9410-Z5-B8	567
05-9416-34-37	509
05-9416-Z5-37	509
05-9434-34-T2	619
05-9438-34-37	533
05-9438-Z5-37	533
05-9439-Z5-37	499
05-9444-Z5-CD	567
05-9447-18-M3	587
05-9456-14-M3	553
05-9456-Z5-M3	553
05-9457-34-M3	525
05-9457-Z5-M3	525
05-9458-34-T2	535
05-9458-J6-T2	535
05-9458-Z5-T2	535
05-9467-34-B8	627
05-9469-34-T2	543
05-9470-34-T2	543
05-9470-Z5-T2	543
05-9471-Z5-T2	553
05-9472-34-M3	541
05-9474-34-37	507
05-9483-34-37	561
05-9484-34-37	561
05-9501-34-37	507
05-9502-34-37	507
05-9509-Z5-37	579
05-9510-Z5-37	579
05-9522-18-M3	587
05-9531-34-T2	533
05-9531-Z5-T2	533
05-9537-34-37	501
05-9538-34-37	501
05-9539-34-37	501
05-9544-Z5-M3	569
05-9553-34-37	509
05-9553-Z5-37	509
05-9555-34-M3	553
05-9559-34-B8	527
05-9565-Z5-B8	555
05-9566-Z5-B8	555
05-9573-34-T2	545
05-9573-Z5-T2	545
05-9574-34-37	545
05-9574-Z5-37	545
05-9577-34-37	529
05-9577-Z5-37	529

Reference	Page
05-9580-34-37	515
05-9583-05-M3	623
05-9589-Z5-T2	619
05-9591-Z5-B8	559
05-9592-34-37	555
05-9593-34-37	557
05-9594-14-37	557
05-9594-34-37	557
05-9595-34-M3	565
05-9596-34-37	627
05-9598-34-M2	515
05-9600-CA-B8	577
05-9601-34-M1	551
05-9602-34-M1	565
05-9605-Z5-M1	571
05-9613-CA-B8	575
05-9626-34-37	505
05-9627-34-37	505
05-9628-34-37	505
05-9629-CA-B8	539
05-9636-34-B8	537
05-9636-Z5-B8	537
05-9637-CA-B8	539
05-9640-05-37	519
05-9640-14-37	519
05-9640-34-37	519
05-9641-34-37	529
05-9641-Z5-37	529
05-9647-34-37	509
05-9647-Z5-37	509
05-9648-34-B8	563
05-9649-14-T2	537
05-9649-34-T2	537
05-9649-Z5-T2	537
05-9650-34-T2	543
05-9652-34-M2	515
05-9653-CA-M2	621
05-9654-CA-M2	621
05-9662-34-CD	525
05-9675-CA-B8	539
05-9677-14-M1	569
05-9679-34-B8	557
05-9679-Z5-B8	557
05-9681-Z5-B8	563
05-9683-14-T2	531
05-9683-34-T2	531
05-9683-Z5-T2	531
05-9684-Z5-T2	531
05-9685-Z5-T2	559
05-9686-Z5-M1	581
05-9687-14-M1	565
05-9705-34-37	625
05-9707-Z5-M2	523
05-9715-Z5-M1	571
05-9717-34-M1	571
05-9718-J6-M3	583
05-9719-34-37	549
05-9722-05-37	509
05-9725-34-T2	555
05-9726-Z5-37	553
05-9727-05-M2	657
05-9728-05-M2	657
05-9731-34-37	515
05-9732-34-37	531

Reference	Page
05-9732-Z5-37	531
05-9734-34-M1	527
05-9735-34-M1	547
05-9739-05-37	513
05-9749-54-37	495
05-9750-54-37	495
05-9751-34-37	501
05-9752-34-CD	557
05-9753-CA-CD	551
05-9757-Y4-37	621
05-9758-34-37	627
05-9762-05-M2	523
05-9763-05-M2	523
05-9770-34-M2	625
05-9771-34-M2	625
05-9772-34-M2	625
05-9773-34-37	541
05-9774-CC-M1	579
05-9776-CA-G5	539
05-9777-CA-G5	577
05-9779-34-M2	563
05-9780-34-M1	575
05-9783-34-M1	527
05-9785-18-AA	593
10-0231-34-05	397
10-0392-21-14	396
10-0392-21-25	396
10-1523-21-21	400
10-1530-21-05	394
10-1530-21-14	394
10-1531-21-05	395
10-1531-21-14	395
10-1566-81-82	330
10-1567-81-82	316
10-1568-81-82	326
10-1788-81-81	349
10-2757-14-82	310
10-2817-81-14	262
10-2825-21-82	306
10-3273-21-05	398
10-3273-E4-Y2	398
10-4339-21-05	260
10-4341-Z6-20	268
10-4343-14-14	251
10-4367-16-82	324
10-4368-16-82	322
10-4369-Z6-82	333
10-4695-21-82	290
10-4695-81-82	290
10-4695-Y2-82	290
10-4696-81-82	288
10-4696-Y2-82	288
10-8790-Y4-M1	717
10-9151-18-E7	683
10-9183-18-B8	719
10-9295-18-M3	681
10-9298-Z5-M3	679
10-9299-14-M1	679
10-9299-Z5-M3	679
10-9329-18-B8	715
10-9329-34-B8	715
10-9333-J6-M1	717
10-9350-18-AA	681
10-9386-34-M3	677

Reference	Page
10-9386-K7-M3	677
10-9386-Z5-M3	677
10-9387-34-M3	677
10-9387-K7-M3	677
10-9387-Z5-M3	677
10-9390-Z5-M3	679
10-9447-18-M3	681
10-9475-Z5-M2	675
10-9555-34-M3	705
10-9556-Z5-M3	703
10-9557-Z5-M3	703
10-9607-34-M1	707
10-9613-CA-B8	715
10-9645-Z5-M2	675
10-9755-M1-M1	671
10-9774-CC-M1	677
10-9784-14-M2	663
10-9785-18-AA	683
127-NS	407
15-0073-14-05	236
15-0074-14-05	236
15-1521-21-E9	390
15-1522-21-E9	390
15-1733-81-F9	433
15-2020-14-14	356
15-2021-14-14	356
15-2300-S4-15	270
15-2456-54-M1	157
15-2459-54-M1	157
15-2462-54-M1	157
15-2463-54-M1	157
15-2464-N3-M1	141
15-2465-N3-M1	141
15-2514-21-F9	434
15-2905-34-M1	388
15-2906-S2-M1	382
15-2907-S2-M1	382
15-2920-S2-M1	159
15-2921-S2-M1	159
15-2936-S2-M1	383
15-2937-S2-M1	383
15-2938-S2-M1	382
15-2939-S2-M1	382
15-2940-S2-M1	383
15-3213-21-B4	430
15-3214-21-B4	430
15-4336-14-M1	392
15-4341-Z6-20	268
15-4370-21-F9	432
15-4426-14-14	251
15-4682-21-E9	390
15-4684-21-E9	390
15-4685-14-M1	386
15-4685-S2-M1	386
15-4686-14-M1	386
15-4686-S2-M1	386
15-4687-14-M1	387
15-4687-S2-M1	387
15-4688-14-M1	387
15-4688-S2-M1	387
15-4689-14-B4	384
15-4689-S2-B4	384
15-4690-14-B4	384
15-4690-S2-B4	384

Reference	Page
15-4691-14-B4	385
15-4691-S2-B4	385
15-4692-14-M1	385
15-4692-S2-M1	385
15-4695-20-M1	264
15-4695-J6-M1	264
15-4696-20-M1	264
15-4696-J6-M1	264
15-4721-54-M1	157
15-4722-54-M1	157
15-4723-54-M1	157
15-4724-54-M1	157
15-4725-N3-M1	141
15-4726-N3-M1	141
15-9234-34-37	601
15-9298-Z5-M3	607
15-9300-34-M3	607
15-9328-34-B8	599
15-9328-Z5-B8	599
15-9350-18-AA	607
15-9362-34-37	601
15-9362-Z5-37	601
15-9363-34-37	601
15-9363-Z5-37	601
15-9365-34-T2	601
15-9365-Z5-T2	601
15-9391-Y4-B8	617
15-9392-Y4-B8	617
15-9480-34-37	599
15-9480-Z5-37	599
15-9491-34-M3	605
15-9493-34-M3	605
15-9540-34-M3	597
15-9542-34-M3	605
15-9558-CA-B8	599
15-9560-34-37	595
15-9561-34-37	595
15-9562-34-37	615
15-9563-34-37	615
15-9619-34-M1	597
15-9659-M3-CD	617
15-9665-CA-37	617
15-9676-34-M3	605
15-9677-14-M1	603
15-9678-14-M1	603
15-9680-34-37	599
15-9688-34-M1	597
15-9696-34-CD	597
15-9708-Y4-37	615
15-9717-34-M1	607
15-9778-34-CD	597
170-NS	300
171-NS	298
172-NS	297
174-NS	302
176-NS	304
20-0544-Y2-20	266
20-0576-Y2-E7	271
20-2012-Z6-82	338
20-2013-Z6-82	336
20-2510-Z6-82	334
20-2787-21-J6	265
20-4341-Z6-20	267
247-NS	408

Reference	Page
248-NS	408
25-0240-21-16	248
25-0240-21-Z5	248
25-0264-21-82	258
25-0264-21-82	258
25-0392-21-14	396
25-0392-21-25	396
25-0467-21-82	259
25-1523-21-21	400
25-1566-81-82	329
25-1567-81-82	318
25-1568-81-82	327
25-2510-Z6-82	339
25-2757-14-82	312
25-2817-81-14	262
25-2825-21-82	307
25-2860-Y2-05	405
25-2860-Y2-14	405
25-3215-14-M1	406
25-3216-14-M3	402
25-3273-21-05	398
25-3273-E4-Y2	398
25-4339-21-05	260
25-4341-Z6-20	268
25-4343-14-14	251
25-4367-16-82	325
25-4695-21-82	295
25-4695-81-82	295
25-4695-Y2-82	295
25-4696-81-82	293
25-4696-Y2-82	293
25-9503-14-M1	671
25-9503-Z5-M1	671
25-9614-14-M1	673
25-9642-14-M1	673
25-9733-05-M1	669
25-9742-Z5-M1	669
271-NS	393
274-NS	371
280-NS	353
284-CR	368
30-0009-N3-B8	489
30-0013-14-M1	468
30-0067-14-14	490
30-0067-81-81	490
30-0068-14-F9	464
30-0068-81-F9	464
30-1854-CF-F9	486
30-1961-81-81	454
30-1961-CF-CF	454
30-1964-CF-CF	456
30-1964-N3-N3	456
30-1965-81-E9	458
30-1966-N3-M1	460
30-1971-81-82	476
30-1975-CF-F9	470
30-1976-J7-M1	472
30-1978-N3-M1	488
30-2009-14-M1	468
30-2854-81-F9	462
30-3248-16-E9	450
30-3248-CG-E9	450
30-3249-CF-M1	448
30-3250-CF-M1	452

Reference	Page
30-4354-81-M1	474
30-4355-81-M1	466
30-4355-CF-M1	466
30-4356-CF-CF	480
30-4357-81-82	476
30-4392-N3-M1	488
30-4393-CF-M1	460
30-4393-N3-M1	460
30-4394-CF-F9	470
30-4395-J7-M1	472
30-4398-J7-J7	478
30-4399-14-F9	482
30-4399-81-F9	482
30-4399-E4-F9	482
30-4399-J7-F9	483
30-4404-81-F9	491
30-4404-CF-F9	491
30-4405-J7-E7	484
320-BL	105, 440
320-CR	105, 440
320-NS	105, 440
331-GR	389
332-GR	388
337-AL	404
35-1557-14-00	73
35-1557-60-00	73
35-1558-14-00	73
35-1558-60-00	73
35-1559-14-00	73
35-1559-60-00	73
35-1565-14-00	73
35-1565-60-00	73
35-2200-14-37	69
35-2200-60-37	69
35-2202-14-37	69
35-2202-60-37	69
35-2204-14-37	69
35-2204-60-37	69
35-2205-14-37	69
35-2205-60-37	69
35-2210-14-37	69
35-2210-60-37	69
35-2215-14-37	69
35-2215-60-37	69
35-2512-14-37	69
35-2512-60-37	69
35-2513-14-37	69
35-2513-60-37	69
35-2515-14-37	69
35-2515-60-37	69
35-2517-14-37	69
35-2517-60-37	69
35-2898-14-00	73
35-2898-60-00	73
35-3510-14-37	69
35-3510-60-37	69
35-3511-14-37	69
35-3511-60-37	69
35-3551-14-00	50
35-3552-14-00	50
35-3553-14-00	50
35-3554-14-00	50

Reference	Page
35-3555-14-37	50
35-3556-14-37	50
35-3557-14-37	50
35-3558-14-37	50
35-3559-14-37	50
35-3560-14-37	50
35-3561-14-37	50
35-3562-14-37	50
35-3563-14-37	50
35-3564-14-37	50
35-3565-14-37	50
35-3566-14-37	50
35-3567-14-37	50
35-3568-14-37	50
35-3569-14-37	50
35-3570-14-37	50
35-3571-14-37	50
35-3572-14-37	50
35-3573-14-37	50
35-3574-14-37	50
35-3575-14-37	50
35-3576-14-37	50
35-3577-14-37	50
35-3578-14-37	50
35-3579-14-00	53
35-3580-14-00	53
35-3581-14-00	53
35-3582-14-00	53
35-3583-14-37	53
35-3584-14-37	53
35-3585-14-37	53
35-3586-14-37	53
35-3587-14-37	53
35-3588-14-37	53
35-3589-14-37	53
35-3590-14-37	53
35-3591-14-37	53
35-3592-14-37	53
35-3593-14-37	53
35-3594-14-37	53
35-3595-14-37	53
35-3596-14-37	53
35-3597-14-37	53
35-3598-14-37	53
35-3599-14-37	53
35-3600-14-37	53
35-3601-14-37	53
35-3602-14-37	53
35-3603-14-37	53
35-3604-14-37	53
35-3605-14-37	53
35-3606-14-37	53
35-3607-14-00	51
35-3608-14-00	51
35-3611-14-00	51
35-3612-14-00	51
35-3613-14-37	51
35-3614-14-37	51
35-3616-14-37	51
35-3617-14-37	51
35-3618-14-37	51
35-3619-14-37	51
35-3621-14-37	51
35-3622-14-37	51

Reference	Page
35-3623-14-37	51
35-3624-14-37	51
35-3625-14-37	51
35-3626-14-37	51
35-3628-14-37	51
35-3629-14-37	51
35-3630-14-37	51
35-3631-14-37	51
35-3632-14-37	51
35-3633-14-37	51
35-3634-14-37	51
35-3635-14-37	51
35-3636-14-37	51
35-3637-14-37	51
35-3638-14-37	51
35-3639-14-37	51
366-NS	433
410-CR	380
411-CR	381
415-CR	380
416-CR	381
425-ES	444
426-ES	444
427-ES	444
434-AL	382
443-AL	375
444-BL	373
445-BL	373
446-NS	349
456-AL	375
457-CR	416
476-CR	444
479-CR	372
482-CR	372
486-BL	426
487-BL	426
488-AL	414
489-AL	414
492-CR	369
493-CR	369
505-NS	371
506-CR	371
510-CR	374
514-GR	391
55-1573-14-00	201
55-1573-N3-00	201
55-1574-14-00	201
55-1574-N3-00	201
55-1699-14-00	201
55-1699-N3-00	201
55-1701-14-00	201
55-1701-N3-00	201
55-8784-05-05	521
55-8790-Y4-M1	717
55-8791-Y4-Y4	573, 717
55-8956-05-M1	709
55-8956-34-M1	709
55-9151-18-18	728, 729
55-9155-M1-M1	663
55-9156-M1-M1	663
55-9172-34-37	521
55-9184-Y4-37	647
55-9186-CA-37	647

Reference	Page
55-9186-Y4-37	647
55-9187-CA-37	639
55-9187-Y4-37	639
55-9190-34-37	701
55-9191-34-37	521
55-9232-Y4-37	637
55-9233-Y4-37	637
55-9238-34-M3	699
55-9239-CA-M2	713
55-9245-CA-37	661
55-9255-54-37	647
55-9257-54-M2	649
55-9264-Y4-37	629
55-9265-Y4-37	629
55-9266-Y4-37	629
55-9268-34-M2	723
55-9269-34-M2	723
55-9280-CA-37	643
55-9280-Y4-37	643
55-9281-Y4-37	645
55-9282-Y4-T2	645
55-9283-Y4-T2	645
55-9293-34-34	721
55-9295-18-M3	719
55-9298-Z5-M3	709
55-9305-48-48	725, 727
55-9317-Y4-M2	713
55-9318-34-M3	675
55-9318-Z5-M3	675
55-9319-34-M3	697
55-9319-Z5-M3	697
55-9320-34-M3	697
55-9320-Z5-M3	697
55-9323-Y4-37	639
55-9329-18-B8	715
55-9329-34-B8	715
55-9333-J6-M1	717
55-9334-Z5-M3	675
55-9335-Z5-M3	695
55-9336-Z5-M3	695
55-9337-Y4-37	647
55-9342-34-M3	697
55-9342-Z5-M3	697
55-9343-34-M3	697
55-9343-Z5-M3	697
55-9349-Z5-M3	521
55-9350-18-AA	719
55-9357-34-M3	695
55-9357-Z5-M3	695
55-9358-34-M3	695
55-9358-Z5-M3	695
55-9374-34-T2	689
55-9380-CA-37	643
55-9380-Y4-37	643
55-9390-14-M1	709
55-9390-Z5-M3	709
55-9421-M3-M3	655
55-9422-34-M3	651
55-9422-Z5-M3	651
55-9423-34-T2	651
55-9423-Z5-T2	651
55-9424-34-T2	651
55-9424-Z5-T2	651

Reference	Page
55-9425-M3-M3	655
55-9426-34-M3	653
55-9426-Z5-M3	653
55-9427-34-T2	653
55-9427-Z5-T2	653
55-9428-34-T2	653
55-9428-Z5-T2	653
55-9430-Y4-T2	641
55-9431-34-M2	723
55-9433-Y4-37	637
55-9440-CA-M2	713
55-9459-Z5-M3	691
55-9479-34-M2	691
55-9481-M1-M1	663
55-9486-Y4-37	641
55-9488-34-M3	699
55-9488-Z5-M3	699
55-9504-34-M2	687
55-9504-Z5-M2	687
55-9505-34-M2	687
55-9505-Z5-M2	687
55-9506-34-M2	687
55-9506-Z5-M2	687
55-9520-M1-M1	665
55-9523-Y4-37	631
55-9524-Y4-37	631
55-9527-Y4-37	631
55-9528-Y4-37	631
55-9530-34-M2	691
55-9549-34-M3	699
55-9549-Z5-M3	699
55-9550-34-M2	685
55-9550-Z5-M2	685
55-9551-34-M2	685
55-9551-Z5-M2	685
55-9552-34-M2	685
55-9552-Z5-M2	685
55-9555-34-M3	705
55-9556-Z5-M3	703
55-9557-Z5-M3	703
55-9564-Y4-37	641
55-9567-Z5-37	643
55-9575-34-M2	691
55-9581-34-M3	701
55-9582-34-M3	701
55-9595-34-M3	705
55-9602-34-M1	705
55-9605-Z5-M1	711
55-9606-Z5-M1	711
55-9607-34-M1	707
55-9613-CA-B8	715
55-9620-54-T2	649
55-9621-54-T2	649
55-9622-14-T2	661
55-9623-14-T2	661
55-9624-18-M3	719
55-9625-CA-37	639
55-9625-Y4-37	639
55-9635-CA-37	643
55-9655-05-CD	693
55-9656-05-CD	693
55-9657-05-CD	693
55-9658-05-CD	693
55-9663-CA-37	635

Reference	Page
55-9664-CA-37	635
55-9665-CA-37	633
55-9666-CA-37	633
55-9667-CA-37	633
55-9669-14-M1	667
55-9670-34-M1	721
55-9682-Z5-37	701
55-9690-34-M2	699
55-9697-14-M3	659
55-9698-14-M3	659
55-9699-14-M3	659
55-9700-14-M3	659
55-9701-Z5-M3	521
55-9706-Z5-CD	689
55-9715-Z5-M1	711
55-9716-Z5-M1	711
55-9717-34-M1	709
55-9720-Z5-M1	707
55-9721-Z5-M1	707
55-9723-CA-37	635
55-9724-CA-37	635
55-9733-05-M1	669
55-9737-CA-37	645
55-9741-Z5-37	655
55-9754-M1-M1	665
55-9756-M1-M1	663
55-9759-Z5-T2	701
55-9760-Z5-37	707
55-9768-54-T2	649
55-9769-54-T2	649
55-9775-Z5-CD	689
60-9151-18-E7	728
60-9152-18-E7	728
60-9294-34-M2	721
60-9307-Z5-M3	727
60-9376-Z5-M3	727
60-9482-Z5-M2	725
60-9785-18-AA	729
60-9786-18-AA	729
71-0017-00-00	879
71-0019-00-00	876
71-0035-00-00	872
71-0036-00-00	872
71-0038-00-00	872
71-0039-00-00	872
71-0059-00-00	872
71-0060-00-00	872
71-0061-00-00	872
71-0062-00-00	872
71-0063-00-00	872
71-0064-00-00	872
71-0065-00-00	872
71-0066-00-00	872
71-0289-54-00	223
71-0299-54-00	223
71-0331-54-00	223
71-0388-54-00	223
71-0537-54-00	157
71-0558-54-00	157, 159
71-0566-54-M2	223
71-0566-54-M3	223
71-0580-54-M2	223
71-0580-54-M3	223

Reference	Page
71-0593-54-M2	223
71-0593-54-M3	223
71-0594-54-M2	223
71-0594-54-M3	223
71-0612-00-00	870
71-0613-00-00	870
71-0727-00-00	879
71-0744-00-00	870
71-1539-14-37	58
71-1553-00-00	879
71-1554-54-00	223
71-1843-81-81	881
71-1843-CF-CF	881
71-1844-81-81	881
71-1844-CF-CF	881
71-1849-14-00	58
71-1881-00-00	83, 85
71-1928-14-00	58
71-1929-14-00	58
71-1930-14-37	58
71-1931-14-37	58
71-1932-14-37	58
71-1933-14-37	58
71-1934-14-37	58
71-1938-05-M2	797
71-1939-05-M2	797
71-1964-CF-CF	456
71-1964-N3-N3	456
71-2232-14-14	77, 881
71-2232-60-60	77, 881
71-2241-00-00	881
71-2337-14-00	59
71-2338-14-00	59
71-2339-14-00	59
71-2340-14-00	59
71-2342-14-00	59
71-2413-00-00	871
71-2467-00-00	799
71-2468-00-00	799
71-2469-00-00	874
71-2471-00-00	874
71-2472-00-00	875
71-2473-05-M2	797
71-2474-05-M2	797
71-2476-00-00	57, 117, 124, 143, 146, 147
71-2477-00-00	873
71-2508-00-00	799
71-2509-00-00	799
71-2625-05-M2	797
71-2654-05-M2	797
71-2675-60-00	69
71-2909-14-37	100
71-2910-14-00	101
71-2910-N3-00	101
71-2911-14-00	101
71-2911-N3-00	101
71-2912-14-00	101
71-2912-N3-00	101

Reference	Page
71-2913-14-00	101
71-2914-14-00	101
71-2914-N3-00	101
71-2915-14-00	101
71-2915-N3-00	101
71-2918-00-00	112, 113
71-2942-14-00	127
71-2942-60-00	127
71-2942-N3-00	127
71-2943-14-00	127
71-2943-60-00	127
71-2943-N3-00	127
71-2944-14-00	127
71-2944-60-00	127
71-2944-N3-00	127
71-2945-14-00	127
71-2945-60-00	127
71-2946-14-00	127
71-2946-60-00	127
71-2947-14-00	127
71-2947-60-00	127
71-2948-14-00	125
71-2948-60-00	125
71-2948-N3-00	125
71-2949-14-00	125
71-2949-60-00	125
71-2949-N3-00	125
71-2950-14-00	125
71-2950-60-00	125
71-2950-N3-00	125
71-2951-14-00	125
71-2951-60-00	125
71-2952-14-00	125
71-2952-60-00	125
71-2953-14-00	125
71-2953-60-00	125
71-2954-00-00	124, 126
71-2955-00-00	124
71-2956-00-00	124
71-2963-00-37	124
71-2964-00-37	124
71-2965-00-37	124
71-2966-00-37	124
71-2967-00-37	124
71-2968-00-37	124
71-2969-00-37	124
71-2970-00-37	124
71-2971-00-37	124
71-2972-00-37	124
71-2973-00-37	124
71-2974-00-37	124
71-2975-00-37	124
71-2976-00-37	124
71-3044-AV-AV	807
71-3128-48-48	802, 804
71-3148-48-48	805
71-3212-00-00	126
71-3223-14-00	139
71-3223-60-00	139
71-3224-00-37	124
71-3225-14-37	100
71-3226-14-37	100

Reference	Page
71-3229-00-00	221
71-3232-00-00	221
71-3255-00-00	798
71-3256-00-00	798
71-3257-00-00	798
71-3281-00-00	852, 857
71-3283-00-00	100
71-3284-00-00	100
71-3285-14-00	76
71-3285-60-00	76
71-3285-N3-00	76
71-3305-00-00	870
71-3307-00-00	870
71-3308-00-00	870
71-3309-00-00	870
71-3411-56-56	212
71-3454-54-M2	223
71-3454-54-M3	223
71-3467-00-00	213
71-3468-00-00	213
71-3473-00-00	879
71-3475-00-00	871
71-3476-00-00	871
71-3477-00-00	870
71-3478-00-00	870
71-3479-00-00	872
71-3493-00-00	877
71-3515-00-37	124
71-3516-00-37	124
71-3517-00-37	124
71-3518-00-37	124
71-3519-00-37	124
71-3520-00-37	124
71-3531-60-00	139
71-3542-00-00	870
71-4393-CF-CF	460
71-4393-N3-N3	460
71-4396-00-00	104, 105
71-4398-J7-F9	478
71-4399-14-14	881
71-4470-BP-BP	789, 800, 804, 805, 807
71-4520-48-48	801, 804, 806
71-4521-48-48	800, 805
71-4522-48-48	802
71-4524-48-48	800, 801, 802, 803, 804, 805, 806
71-4525-48-48	800, 801, 802, 803
71-4526-48-48	767, 769, 771

Reference	Page
71-4531-48-48	800, 801, 802, 803, 806
71-4539-48-48	800, 801, 802, 803, 806
71-4540-48-48	801, 803
71-4541-48-48	801
71-4553-AV-AV	765
71-4554-AV-AV	807
71-4555-AV-AV	807
71-4556-48-48	765
71-4655-N3-00	209
71-4661-N3-N3	195
71-4662-00-00	876
71-4663-00-00	876
71-4664-00-00	221
71-4665-00-00	221
71-4666-00-00	877
71-4695-81-81	264
71-4704-00-00	870
71-4706-00-00	871
71-4707-00-00	871
71-4708-00-00	871
71-4722-N3-00	157, 159
71-4723-N3-00	157, 159
71-4724-N3-00	157
71-4725-00-00	870
71-4727-00-00	872
71-4768-00-00	799
71-4769-00-00	799
71-8969-00-00	537, 619, 621, 881
71-9187-Y4-37	639
71-9197-05-05	873
71-9198-05-05	872
71-9199-05-05	880
71-9262-05-05	881
71-9273-05-05	880
71-9291-34-34	725
71-9292-34-34	725
71-9311-05-05	881
71-9396-05-05	880
71-9397-05-05	880
71-9398-05-05	727
71-9399-05-05	727
71-9405-M3-M3	880
71-9406-M3-M3	880
71-9442-00-00	727
71-9445-Z5-Z5	567
71-9448-CA-CA	615, 645
71-9449-CA-CA	645
71-9450-CA-CA	647
71-9452-CA-CA	647
71-9453-CA-CA	637, 639
71-9454-CA-CA	641
71-9476-08-08	651

Reference	Page
71-9476-11-11	651
71-9476-24-24	651
71-9476-25-25	651
71-9477-08-08	653
71-9477-11-11	653
71-9477-24-24	653
71-9477-25-25	653
71-9487-34-34	509, 515, 519, 881
71-9487-Z5-Z5	509, 519, 521, 881
71-9507-05-05	880
71-9508-00-00	725
71-9512-CA-CA	641
71-9514-52-52	723
71-9515-52-52	723
71-9520-00-00	665
71-9574-05-37	545
71-9577-05-37	529
71-9583-Z5-Z5	623
71-9584-Z5-Z5	623
71-9585-Z5-Z5	623
71-9586-Z5-Z5	623
71-9587-Z5-Z5	623
71-9588-Z5-Z5	623
71-9630-34-34	877
71-9632-34-34	877
71-9638-CA-CA	637, 639
71-9639-CA-CA	647
71-9709-00-00	623
71-9710-00-00	623
71-9711-00-00	603, 605
71-9712-00-00	603, 605
71-9713-00-00	619, 621
71-9714-00-00	619, 621
71-9729-54-M3	661
71-9744-05-05	880
71-9745-05-05	880
71-9746-05-05	509, 515, 519, 521, 881
71-9747-00-00	537, 539
71-9781-00-00	537, 539
75-4366-21-K3	445
75-4371-K3-M1	442
80-4552-AU-M2	763
80-1413-BK-37	187
80-1414-BK-37	187
80-1423-BP-H6	511
80-1424-BP-H6	511
80-1481-BK-37	187
80-1503-BK-37	187
80-1504-BK-37	187
80-1505-BK-37	187
80-1506-BP-H6	511

Reference	Page
80-1767-AT-37	733
80-1769-AT-37	733
80-1780-AT-37	733
80-2417-BP-37	779
80-2418-BP-37	779
80-2419-BP-37	779
80-2421-BP-37	779
80-2422-BP-37	785
80-2423-BP-37	785
80-2424-BP-37	785
80-2425-BP-37	785
80-2426-BP-37	773
80-2427-BP-37	773
80-2428-BP-37	773
80-2429-BP-37	773
80-2430-AU-M2	791
80-2431-AU-M2	791
80-2432-AU-M2	791
80-2433-AU-M2	791
80-2434-AU-M2	791
80-2435-AU-M2	791
80-2436-AU-M2	791
80-2437-AU-M2	791
80-2438-AT-37	749
80-2439-AT-37	749
80-2440-AT-37	749
80-2441-AT-37	749
80-2442-AT-37	749
80-2443-AT-37	749
80-2444-AT-37	749
80-2445-AT-37	749
80-2446-AT-37	749
80-2447-AT-37	749
80-2448-AT-37	749
80-2449-AT-37	749
80-2467-BQ-37	743
80-2617-AT-37	731
80-2618-AT-37	731
80-2674-AT-37	751
80-2693-BQ-37	759
80-2694-BQ-37	759
80-2695-BQ-37	759
80-2696-BQ-37	743
80-2926-BP-37	773
80-2927-BP-37	773
80-3001-BP-37	782
80-3002-BP-37	782
80-3003-BP-37	782
80-3004-BP-37	782
80-3005-BP-37	782
80-3006-BP-37	782
80-3007-BP-37	782
80-3008-BP-37	782
80-3009-BP-37	782
80-3010-BP-37	782
80-3011-BP-37	782
80-3012-BP-37	776
80-3013-BP-37	776
80-3014-BP-37	776
80-3015-BP-37	776
80-3016-BP-37	776
80-3017-BP-37	776
80-3018-BP-37	776
80-3019-BP-37	776

Reference	Page
80-3020-BP-37	776
80-3021-BP-37	776
80-3022-BP-37	776
80-3023-BQ-37	759
80-3025-BP-37	776
80-3026-BP-37	776
80-3027-BP-37	776
80-3028-BP-37	782
80-3029-BQ-37	745
80-3030-BQ-37	745
80-3031-BQ-37	745
80-3032-BQ-37	745
80-3033-BQ-37	745
80-3034-BQ-37	745
80-3039-BQ-37	745
80-3040-BQ-37	745
80-3041-BQ-37	745
80-3042-BP-37	776
80-3044-BS-37	739
80-3045-BS-37	739
80-3046-BS-37	739
80-3047-BS-37	739
80-3048-BS-37	739
80-3049-BS-37	739
80-3054-BS-37	739
80-3055-BS-37	739
80-3056-BS-37	739
80-3057-BS-37	739
80-3058-BS-37	739
80-3059-BS-37	739
80-3062-BQ-37	745
80-3063-BQ-37	745
80-3064-BQ-37	745
80-3065-BQ-37	745
80-3066-BQ-37	745
80-3067-BQ-37	745
80-3070-BQ-37	745
80-3071-AT-37	751
80-3072-AT-37	751
80-3073-AT-37	751
80-3074-AT-37	751
80-3075-AT-37	751
80-3076-AT-37	751
80-3081-AT-37	751
80-3082-AT-37	751
80-3083-AT-37	751
80-3084-AT-37	751
80-3085-AT-37	751
80-3086-AT-37	751
80-3087-AT-37	751
80-3088-AT-37	751
80-3089-AT-37	751
80-3090-AT-37	751
80-3091-AT-37	751
80-3092-AT-37	751
80-3093-AT-37	751
80-3094-AT-37	751
80-3095-AT-37	751
80-3096-AT-37	751
80-3097-AT-37	751
80-3098-AT-37	751
80-3125-AU-M2	793
80-3126-AU-M2	793
80-3127-AU-M2	793

Reference	Page
80-3129-AU-M2	793
80-3130-AU-M2	793
80-3131-AU-M2	793
80-3134-AU-M2	793
80-3135-AU-M2	793
80-3136-AU-M2	793
80-3138-AU-M2	793
80-3139-AU-M2	793
80-3141-AU-M2	793
80-3142-AU-M2	793
80-3143-AU-M2	793
80-3144-AU-M2	793
80-3146-AU-M2	793
80-3147-AU-M2	793
80-3149-AU-M2	793
80-3173-BP-37	782
80-3174-BP-37	782
80-3175-BP-37	782
80-3176-BP-37	782
80-3177-BP-37	782
80-3178-BP-37	782
80-3179-BP-37	776
80-3180-BP-37	776
80-3181-BP-37	776
80-3182-BQ-37	745
80-3183-BQ-37	745
80-3235-AT-37	733
80-3236-AT-37	733
80-3237-AT-37	733
80-3238-BS-37	737
80-3252-AT-37	751
80-3253-AT-37	751
80-3257-BP-37	777
80-3258-BP-37	777
80-3261-BP-37	783
80-3262-BP-37	783
80-3265-BP-37	789
80-3266-BP-37	789
80-3269-AU-M2	795
80-3270-AU-M2	795
80-3274-BQ-37	743
80-3275-BP-37	777
80-3276-BP-37	783
80-3277-BP-37	789
80-3278-AU-M2	795
80-4470-BP-37	788
80-4471-BP-37	788
80-4472-BP-37	788
80-4473-BP-37	788
80-4474-BP-37	788
80-4475-BP-37	788
80-4476-BP-37	788
80-4477-BP-37	788
80-4478-BP-37	788
80-4479-BP-37	788
80-4480-BP-37	788
80-4481-BP-37	788
80-4482-BP-37	788
80-4483-BP-37	788
80-4484-BP-37	788
80-4485-BP-37	788
80-4486-BP-37	788
80-4487-BP-37	788
80-4492-BP-37	788

Reference	Page
80-4494-BQ-37	760
80-4495-BQ-37	760
80-4496-BQ-37	760
80-4497-BQ-37	760
80-4498-BQ-37	760
80-4499-BQ-37	760
80-4500-BQ-37	760
80-4501-BQ-37	760
80-4502-BQ-37	760
80-4503-BQ-37	760
80-4504-BQ-37	760
80-4505-BQ-37	760
80-4506-BQ-37	760
80-4507-BQ-37	760
80-4508-BQ-37	760
80-4509-BQ-37	760
80-4510-BQ-37	760
80-4511-BQ-37	760
80-4512-BQ-37	760
80-4513-BQ-37	760
80-4514-BQ-37	760
80-4515-BQ-37	760
80-4516-BQ-37	760
80-4517-BQ-37	760
80-4518-BQ-37	760
80-4519-BQ-37	760
80-4520-BP-37	785
80-4521-BQ-37	760
80-4522-BQ-37	760
80-4523-BP-37	776
80-4524-BP-37	776
80-4525-BP-37	782
80-4528-BP-37	779
80-4529-BP-37	773
80-4538-BP-37	779
80-4542-BP-37	779
80-4543-BP-37	779
80-4545-BP-37	782
80-4552-AU-M2	763
80-4553-AU-M2	763
80-4562-BP-37	773
80-4566-BP-37	773
80-4567-BP-37	773
80-4569-BP-37	788
80-4570-BP-37	788
80-4571-AU-M2	793
80-4572-AU-M2	793
80-4573-BQ-M2	755
80-4574-BQ-M2	755
80-4575-BQ-M2	755
80-4576-BQ-M2	755
80-4577-BQ-M2	755
80-4578-BQ-M2	755
80-4579-BQ-M2	755
80-4592-BP-37	776
80-4593-BP-37	776
80-4594-BP-37	776
80-4595-BP-37	782
80-4596-BP-37	782
80-4597-BP-37	782
80-4598-AT-37	751
80-4599-AT-37	751
80-4600-AT-37	751
80-4601-AT-37	751

Reference	Page
80-4602-BQ-37	760
80-4603-BQ-37	760
80-4604-BQ-37	760
80-4605-AU-M2	793
80-4606-AU-M2	793
80-4607-AU-M2	793
80-4610-BQ-37	743
80-4614-BQ-37	743
80-4615-BQ-37	743
80-4616-BQ-37	743
80-4618-BQ-37	759
80-4622-BQ-37	759
80-4623-BQ-37	759
80-4624-BQ-37	759
80-4626-BP-37	775
80-4627-BP-37	775
80-4628-BP-37	775
80-4629-BP-37	775
80-4630-BP-37	775
80-4631-BP-37	775
80-4632-BP-37	775
80-4633-BP-37	775
80-4634-BP-37	775
80-4635-BP-37	775
80-4636-BP-37	775
80-4637-BP-37	775
80-4638-BP-37	775
80-4639-BP-37	775
80-4640-BP-37	775
80-4641-BP-37	775
80-4642-BP-37	775
80-4643-BP-37	775
80-4644-BP-37	775
80-4645-BP-37	775
80-4646-BP-37	775
80-4647-BP-37	775
80-4648-BP-37	775
80-4649-BP-37	781
80-4650-BP-37	781
80-4651-BP-37	781
80-4652-BP-37	781
80-4653-BP-37	781
80-4654-BP-37	781
80-4655-BP-37	781
80-4656-BP-37	781
80-4657-BP-37	781
80-4658-BP-37	781
80-4659-BP-37	781
80-4660-BP-37	781
80-4661-BP-37	781
80-4662-BP-37	781
80-4663-BP-37	781
80-4664-BP-37	781
80-4665-BP-37	781
80-4666-BP-37	781
80-4667-BP-37	781
80-4668-BP-37	781
80-4669-BP-37	781
80-4670-BP-37	781
80-4671-BP-37	781
80-4672-BP-37	787
80-4673-BP-37	787
80-4674-BP-37	787
80-4675-BP-37	787

Reference	Page
80-4676-BP-37	787
80-4677-BP-37	787
80-4678-BP-37	787
80-4679-BP-37	787
80-4680-BP-37	787
80-4681-BP-37	787
80-4682-BP-37	787
80-4683-BP-37	787
80-4684-BP-37	787
80-4685-BP-37	787
80-4686-BP-37	787
80-4687-BP-37	787
80-4688-BP-37	787
80-4689-BP-37	787
80-4690-BP-37	787
80-4691-BP-37	787
80-4692-BP-37	785
80-4697-BP-37	785
80-4698-BP-37	785
80-4700-AU-M2	794
80-4701-AU-M2	794
80-4702-AU-M2	794
80-4703-AU-M2	794
80-4704-AU-M2	794
80-4705-AU-M2	794
80-4706-AU-M2	794
80-4707-AU-M2	794
80-4708-AU-M2	794
80-4709-AU-M2	794
80-4710-AU-M2	794
80-4711-AU-M2	794
80-4712-AU-M2	794
80-4713-AU-M2	794
80-4714-AU-M2	794
80-4715-AU-M2	794
80-4716-AU-M2	794
80-4717-AU-M2	794
80-4718-AU-M2	794
80-4719-AU-M2	794
80-4720-AU-M2	794
80-4721-AU-M2	794
80-4722-AU-M2	794
80-4744-AT-37	731
80-4748-AT-37	731
80-4749-AT-37	731
80-4750-AT-37	731
80-4752-AT-37	731
80-4753-AT-37	731
80-4754-AT-37	731
80-4768-BQ-37	743
80-4769-BP-37	787
80-4771-AT-37	751
80-4772-BP-37	788
80-4773-BP-37	787
80-4774-BQ-37	745
80-4775-BQ-37	745
80-4776-BQ-37	745
80-4777-BQ-37	745
80-4778-BQ-37	745
80-4779-BP-37	776
80-4780-BP-37	776
80-4781-BP-37	776
80-4782-BP-37	776
80-4783-BP-37	776

Reference	Page
80-4784-BP-37	776
80-4786-BP-37	775
80-4787-BP-37	775
80-4788-BP-37	775
80-4789-BP-37	775
80-4790-BP-37	775
80-4791-BP-37	775
80-4793-BP-37	782
80-4794-BP-37	782
80-4795-BP-37	782
80-4796-BP-37	782
80-4797-BP-37	782
80-4798-BP-37	782
80-4799-BP-37	781
80-4800-BP-37	781
80-4801-BP-37	781
80-4802-BP-37	781
80-4803-BP-37	781
80-4804-BP-37	781
80-4805-BP-37	788
80-4806-BP-37	788
80-4807-BP-37	788
80-4808-BP-37	788
80-4809-BP-37	788
80-4810-BP-37	788
80-4811-BP-37	787
80-4812-BP-37	787
80-4813-BP-37	787
80-4814-BP-37	787
80-4815-BP-37	787
80-4816-BP-37	787
80-4817-AU-M2	793
80-4818-AU-M2	793
80-4819-AU-M2	793
80-4820-AU-M2	793
80-4821-AU-M2	793
80-4822-AU-M2	793
80-4823-AU-M2	794
80-4824-AU-M2	794
80-4825-AU-M2	794
80-4826-AU-M2	794
80-4827-AU-M2	794
80-4828-AU-M2	794
80-4829-BS-37	739
80-4830-BS-37	739
80-4831-BS-37	739
80-4832-BS-37	739
80-4833-BS-37	739
80-4834-BS-37	739
80-4835-BQ-M2	755
80-4836-BQ-M2	755
80-4837-BQ-M2	755
80-4838-AT-37	751
80-4839-AT-37	751
80-4840-AT-37	751
80-4841-AT-37	751
80-4842-AT-37	751
80-4843-AT-37	751
80-8928-BP-37	779
80-8929-BP-37	779
80-8930-BP-37	785
80-8931-BP-37	785
80-8932-AU-M2	791
80-8933-AU-M2	791

Reference	Page
81-3123-BP-BP	805
81-3128-AU-AU	802
81-3132-AU-AU	802
81-3133-AU-AU	802
81-3137-AU-AU	806
81-3140-AU-AU	806
81-3145-BP-BP	804
81-3149-AV-AV	801
81-3151-AV-AV	801
81-3255-AV-AV	800
81-3256-AV-AV	800
81-3257-AV-AV	800
81-4531-BP-AV	803
81-4532-BP-AV	803
81-4533-BP-AV	803
81-4534-AV-AV	801
81-4535-AV-AV	801
81-4536-AV-AV	801
81-4537-AV-AV	801
81-4538-AV-AV	801
81-4552-AV-AV	765
81-4556-AV-AV	765
81-4557-AV-AV	765
81-4558-AV-AV	765
81-4768-AV-AV	800
82-3012-BP-BP	807
82-3029-BQ-BQ	807
82-3030-BQ-BQ	807
82-3124-BP-BP	807
83-3099-BB-M2	771
83-3101-BB-M2	771
83-3102-BB-M2	771
83-3103-BB-M2	771
83-3104-BB-M2	771
83-3105-BB-M2	771
83-3117-BB-M2	771
83-3118-BB-M2	771
83-3119-BB-M2	771
83-3184-BB-M2	771
83-3185-BB-M2	771
83-3186-BB-M2	771
83-3239-BB-M2	767
83-4580-BB-M2	769
83-4581-BB-M2	769
83-4582-BB-M2	769
83-4583-BB-M2	769
83-4584-BB-M2	769
83-4585-BB-M2	769
83-4586-BB-M2	769
83-4587-BB-M2	769
83-4588-BB-M2	769
83-4589-BB-M2	769
83-4591-BB-M2	769
83-4608-BB-M2	769
83-4609-BB-M2	769
90-0713-14-M3	144
90-0713-N3-M3	144
90-0714-14-M3	144
90-0714-N3-M3	144
90-0723-14-M3	144
90-0723-N3-M3	144
90-0724-14-M3	144
90-0724-N3-M3	144

Reference	Page
90-0861-14-M3	145
90-0861-N3-M3	145
90-0907-14-M3	145
90-0907-N3-M3	145
90-0908-14-M3	145
90-0908-N3-M3	145
90-0931-14-M3	145
90-0931-N3-M3	145
90-1453-14-T2	154
90-1454-14-T2	154
90-1480-14-T2	154
90-1689-21-37	104, 436
90-1690-21-37	104, 436
90-1720-14-00	85
90-1722-14-00	85
90-1782-14-37	97
90-1783-14-M3	153
90-1784-14-M3	153
90-1785-14-M3	153
90-1789-21-37	104, 436
90-1792-21-37	104, 436
90-1809-14-00	85
90-1813-14-00	85
90-1884-S2-N3	114
90-1888-S2-N3	114
90-1893-S2-N3	115
90-1895-S2-N3	114
90-1898-S2-N3	114
90-1902-S2-N3	115
90-1914-S2-N3	114
90-1921-S2-N3	114
90-1922-S2-N3	115
90-1923-S2-N3	114
90-1924-S2-N3	114
90-1925-S2-N3	114
90-2023-14-M3	146
90-2023-N3-M3	146
90-2025-14-M3	146
90-2025-N3-M3	146
90-2027-14-M3	146
90-2027-N3-M3	146
90-2029-14-M3	146
90-2029-N3-M3	146
90-2064-14-M3	147
90-2064-N3-M3	147
90-2069-14-M3	147
90-2069-N3-M3	147
90-2073-14-M3	147
90-2073-N3-M3	147
90-2077-14-M3	147
90-2077-N3-M3	147
90-2501-14-00	162
90-2502-14-00	150
90-2520-14-37	57
90-2521-14-37	57
90-2522-14-37	57
90-2534-14-37	57
90-2556-14-37	57
90-2581-14-37	57
90-2582-14-37	57
90-2594-14-37	57

Reference	Page
90-2599-14-37	57
90-2605-14-37	57
90-2611-14-37	57
90-2613-14-37	57
90-2614-14-37	57
90-2615-14-37	57
90-2616-14-37	57
90-2899-14-M3	155
90-2902-14-00	83
90-2903-14-00	83
90-2977-14-37	143
90-2977-N3-37	143
90-2978-14-37	143
90-2978-N3-37	143
90-2979-14-37	143
90-2979-N3-37	143
90-2980-14-37	143
90-2980-N3-37	143
90-2981-14-00	138
90-2981-60-00	138
90-2982-14-00	138
90-2982-60-00	138
90-2983-14-00	138
90-2983-60-00	138
90-2984-14-00	138
90-2984-60-00	138
90-2985-14-37	139
90-2985-60-37	139
90-2986-14-37	139
90-2986-60-37	139
90-2987-14-37	139
90-2987-60-37	139
90-2988-14-37	139
90-2988-60-37	139
90-2989-14-37	139
90-2989-60-37	139
90-2990-14-37	139
90-2990-60-37	139
90-2991-14-37	138
90-2991-60-37	138
90-2992-14-37	138
90-2992-60-37	138
90-2993-14-37	138
90-2993-60-37	138
90-2994-14-37	138
90-2994-60-37	138
90-2995-14-37	138
90-2995-60-37	138
90-2996-14-37	138
90-2996-60-37	138
90-2997-14-37	138
90-2997-60-37	138
90-2998-14-37	138
90-2998-60-37	138
90-2999-14-37	138
90-2999-60-37	138
90-3000-14-37	138
90-3000-60-37	138
90-3204-14-37	138
90-3204-60-37	138
90-3207-14-37	138
90-3207-60-37	138
90-3208-14-37	139
90-3208-60-37	139

Reference	Page
90-3209-14-37	139
90-3209-60-37	139
90-3210-14-37	139
90-3210-60-37	139
90-3211-14-37	139
90-3211-60-37	139
90-3240-14-37	113
90-3240-N3-37	113
90-3241-14-37	113
90-3241-N3-37	113
90-3242-14-37	112
90-3242-N3-37	112
90-3243-14-37	112
90-3243-N3-37	112
90-3291-14-37	117
90-3291-N3-37	117
90-3292-14-37	117
90-3292-N3-37	117
90-3293-14-37	117
90-3293-N3-37	117
90-3294-14-37	117
90-3294-N3-37	117
90-3295-14-37	117
90-3295-N3-37	117
90-3296-14-37	117
90-3296-N3-37	117
90-3297-14-37	117
90-3297-N3-37	117
90-3298-14-37	117
90-3298-N3-37	117
90-3299-14-37	117
90-3299-N3-37	117
90-3475-14-14	87
90-3476-14-14	87
90-3476-14-N3	87
90-3477-14-14	87
90-3478-14-14	87
90-3478-14-N3	87
90-3489-54-S2	191
90-3490-54-S2	191
90-3501-14-37	117
90-3501-N3-37	117
90-3502-14-37	117
90-3502-N3-37	117
90-3503-14-37	117
90-3503-N3-37	117
90-3504-14-37	117
90-3504-N3-37	117
90-3505-14-37	117
90-3505-N3-37	117
90-3506-14-37	117
90-3506-N3-37	117
90-3507-14-37	117
90-3507-N3-37	117
90-3508-14-37	117
90-3508-N3-37	117
90-3509-14-37	117
90-3509-N3-37	117
90-3512-14-37	57
90-3513-14-37	57
90-3514-14-37	57
90-3521-14-37	143
90-3521-N3-37	143
90-3522-14-37	143

Reference	Page
90-3522-N3-37	143
90-3523-14-37	138
90-3523-60-37	138
90-3524-14-37	138
90-3524-60-37	138
90-3525-14-37	138
90-3525-60-37	138
90-3526-14-37	138
90-3526-60-37	138
90-3527-14-37	138
90-3527-60-37	138
90-3528-14-37	138
90-3528-60-37	138
90-3529-14-37	139
90-3529-60-37	139
90-3530-14-37	139
90-3530-60-37	139
90-3546-14-00	133
90-3546-60-00	133
90-3546-N3-00	133
90-3547-14-00	134
90-3547-60-00	134
90-3547-N3-00	134
90-3548-14-00	134
90-3548-60-00	134
90-3548-N3-00	134
90-3549-14-00	135
90-3549-60-00	135
90-3549-N3-00	135
90-3550-14-00	133
90-3550-60-00	133
90-3550-N3-00	133
90-4349-14-B9	105, 438
90-4350-05-05	105
90-4350-14-14	105
91-0150-00-00	218
91-0171-00-00	220
91-0175-00-00	220
91-2343-00-00	215
91-2353-00-00	215
91-2361-00-00	219
91-2365-00-00	219
91-2379-00-00	219
91-2488-00-00	218
91-2491-00-00	220
91-2492-00-00	213
91-3227-00-00	221
91-3228-00-00	221
91-3244-00-00	221
91-3245-00-00	221
91-3282-00-00	219
91-3408-54-M2	212
91-3411-54-M2	212
91-3419-00-00	216
91-3420-00-00	216
91-3473-00-00	214
91-4671-00-00	217
ACT-0065-14-00	119
ACT-0065-N3-00	119
ACT-0066-14-00	119
ACT-0066-N3-00	119
ACT-0067-14-00	119
ACT-0067-N3-00	119

Reference	Page
ACT-0068-14-00	119
ACT-0068-N3-00	119
ACT-0294-00-00	106
ACT-0364-00-00	205
ACT-0365-00-00	205
ACT-0451-00-00	70, 74, 75, 118, 125
ACT-0452-00-00	70, 74, 75, 118, 125
ACT-0453-00-00	70, 74, 75, 118, 125
ACT-0454-00-00	70, 74, 75, 118, 125
ACT-0455-60-00	74, 75
ACT-0803-00-00	870
ACT-0804-00-00	870
ACT-0808-00-00	870
ACT-9044-14-00	135
ACT-9044-60-00	135
ACT-9044-N3-00	135
ACT-9045-14-00	135
ACT-9045-60-00	135
ACT-9045-N3-00	135
ACT-9083-N3-00	175, 177
ACT-9090-14-00	175, 177
ACT-9090-N3-00	175, 177, 178
ACT-9091-N3-00	175, 177, 178
ACT-9092-00-00	175
ACT-9093-00-00	177, 178
ACT-9096-00-00	175
ACT-9097-00-00	177, 178
ACT-9105-14-00	73
ACT-9105-60-00	73
ACT-9106-14-00	73
ACT-9106-60-00	73
ACT-9110-14-B9	163
ACT-9110-N3-B9	163
ACT-9111-14-B9	163
ACT-9111-N3-B9	163
ACT-9112-14-B9	163
ACT-9112-N3-B9	163
ACT-9113-14-B9	163
ACT-9113-N3-B9	163
ACT-9114-00-00	175
ACT-9115-14-F1	163
ACT-9115-N3-F1	163
ACT-9116-14-F1	163
ACT-9116-N3-F1	163
ACT-9117-14-F1	163

Reference	Page
ACT-9117-N3-F1	163
ACT-9118-14-F1	163
ACT-9118-N3-F1	163
ACT-9119-14-H6	163
ACT-9119-N3-H6	163
ACT-9120-14-H6	163
ACT-9120-N3-H6	163
ACT-9121-14-H6	163
ACT-9121-N3-H6	163
ACT-9122-14-H6	163
ACT-9122-N3-H6	163
ACT-9127-08-00	50, 51, 53, 57, 58, 63, 65
ACT-9127-11-00	50, 51, 53, 57, 58, 63, 65
ACT-9127-24-00	50, 51, 53, 57, 58, 63, 65
ACT-9127-25-00	50, 51, 53, 57, 58, 63, 65
ACT-9131-08-00	50, 51, 53, 58, 63, 65, 70, 73, 74, 75, 89, 108, 118, 125, 128, 130, 135, 183
ACT-9131-11-00	50, 51, 53, 58, 63, 65, 70, 73, 74, 75, 89, 108, 118, 125, 128, 130, 135, 183

Reference	Page	Reference	Page	Reference	Page	Reference	Page
ACT-9131-24-00	50, 51, 53, 58, 63, 65, 70, 73, 74, 75, 89, 108, 118, 125, 128, 130, 135, 183	ACT-9155-14-M1	177	ACT-FLL-042	853	CR-0323-14-00	76
ACT-9131-25-00	50, 51, 53, 58, 63, 65, 70, 73, 74, 75, 89, 108, 118, 125, 128, 130, 135	ACT-9155-N3-M1	177	ACT-FLL-043	853	CR-0323-60-00	76
ACT-9135-60-00	50, 51, 53, 57, 58, 63, 65	ACT-9165-48-00	76	ACT-FLL-044	853	CR-0323-N3-00	76
ACT-9138-14-T2	165	ACT-9171-14-T2	151	ACT-FLL-045	853	CR-0324-14-00	76
ACT-9138-N3-T2	165	ACT-9171-N3-T2	151	ACT-FLL-046	853	CR-0324-60-00	76
ACT-9139-14-T2	165	ACT-9172-14-T2	151	ACT-FLL-047	853	CR-0324-N3-00	76
ACT-9139-N3-T2	165	ACT-9172-N3-T2	151	ACT-FLL-049	857	CR-0325-14-00	77
ACT-9140-14-T2	165	ACT-9173-14-H6	151	ACT-FLL-050	857	CR-0325-60-00	77
ACT-9140-N3-T2	165	ACT-9173-N3-H6	151	ACT-FLQ-001	856	CR-0326-14-00	77
ACT-9141-14-T2	165	ACT-9180-60-00	70, 118, 125	ACT-FLQ-002	856	CR-0326-60-00	77
ACT-9141-N3-T2	165	ACT-9181-14-00	70	ACT-FLQ-003	856	CR-0327-14-00	77
ACT-9142-14-T2	165	ACT-9181-60-00	70	ACT-FLQ-004	856	CR-0327-60-00	77
ACT-9142-N3-T2	165	ACT-BAL-003	873	ACT-FLQ-005	856	CR-0328-14-00	77
ACT-9143-14-T2	165	ACT-BAL-004	873	ACT-FLQ-006	856	CR-0328-60-00	77
ACT-9143-N3-T2	165	ACT-BAL-005	873	ACT-TRA-001	873	CR-0329-14-00	77
ACT-9144-14-T2	165	ACT-BAL-006	873	ACT-TRA-002	873	CR-0329-60-00	77
ACT-9144-N3-T2	165	ACT-BAL-007	873	ACT-TRA-003	873	CR-0331-14-00	77
ACT-9145-14-T2	165	ACT-BAL-008	873	ACT-TRA-004	873	CR-0331-60-00	77
ACT-9145-N3-T2	165	ACT-BAL-009	873	AD-0654-N3-00	178	CR-0332-14-00	77
ACT-9146-14-H6	165	ACT-BAL-010	873	AD-0656-N3-00	174	CR-0332-60-00	77
ACT-9146-N3-H6	165	ACT-BAL-011	873	AD-0657-14-00	174	CR-0333-14-00	77
ACT-9147-14-H6	165	ACT-FLF-003	855	AD-0657-N3-00	174	CR-0333-N3-00	77
ACT-9147-N3-H6	165	ACT-FLF-004	855	AD-0658-N3-00	174	CR-0334-14-00	77
ACT-9148-14-H6	165	ACT-FLF-005	855	AD-0659-N3-00	174	CR-0334-N3-00	77
ACT-9148-N3-H6	165	ACT-FLF-006	855	AD-0660-14-00	174	CR-0335-00-00	77
ACT-9149-14-H6	165	ACT-FLF-009	855	AD-0660-N3-00	174	CR-0336-14-00	77
ACT-9149-N3-H6	165	ACT-FLF-010	855	AD-0661-N3-00	174	CR-0336-N3-00	77
ACT-9150-14-M1	175	ACT-FLF-011	855	AD-0662-N3-00	176	CR-0337-14-00	76
ACT-9150-N3-M1	175	ACT-FLF-012	855	AD-0663-14-00	176	CR-0337-60-00	76
ACT-9151-14-M1	177	ACT-FLF-013	855	AD-0663-N3-00	176	CR-0337-N3-00	76
ACT-9151-N3-M1	177	ACT-FLF-014	855	AD-0664-N3-00	176	CR-0338-14-00	76
ACT-9152-14-M1	175	ACT-FLF-021	855	AD-0665-N3-00	176	CR-0338-60-00	76
ACT-9153-14-M1	177	ACT-FLF-022	855	AD-0666-14-00	176	CR-0338-N3-00	76
ACT-9154-14-M1	175	ACT-FLF-023	855	AD-0666-N3-00	176	DF-20	846
ACT-9154-N3-M1	175	ACT-FLF-042	856	AD-0680-N3-00	174	DF-25	846
		ACT-FLF-043	856	AD-0681-14-00	174	DF-50-A	847
		ACT-FLF-044	856	AD-0681-N3-00	174	DF-50-B	847
		ACT-FLF-045	856	AD-0682-N3-00	174	DF-50-C	847
		ACT-FLL-011	852	AD-0683-N3-00	174	DM-0048-N3-00	93
		ACT-FLL-013	852	AD-0684-14-00	174	DM-0049-N3-00	93
		ACT-FLL-015	852	AD-0684-N3-00	174	DM-0050-N3-00	93
		ACT-FLL-017	852	AD-0685-N3-00	174	DM-0053-14-00	129
		ACT-FLL-019	857	AD-0686-N3-00	176	DM-0053-N3-00	129
		ACT-FLL-020	857	AD-0687-14-00	176	DM-0054-14-00	129
		ACT-FLL-021	857	AD-0687-N3-00	176	DM-0054-N3-00	129
		ACT-FLL-022	857	AD-0688-N3-00	176	DM-0055-14-00	129
		ACT-FLL-023	857	AD-0689-N3-00	176	DM-0055-N3-00	129
		ACT-FLL-024	857	AD-0690-14-00	176	DM-0056-14-00	129
		ACT-FLL-025	857	AD-0690-N3-00	176	DM-0056-N3-00	129
		ACT-FLL-026	857	AD-0691-N3-00	174	DM-0061-14-00	128
		ACT-FLL-027	857	AD-0692-14-00	174	DM-0061-N3-00	128
		ACT-FLL-028	857	AD-0692-N3-00	174	DM-0062-14-00	128
		ACT-FLL-029	857	AD-0693-N3-00	174	DM-0062-N3-00	128
		ACT-FLL-030	852	AD-0694-N3-00	174	DM-0063-14-00	128
		ACT-FLL-031	852	AD-0695-14-00	174	DM-0063-N3-00	128
		ACT-FLL-032	852	AD-0695-N3-00	174	DM-0064-14-00	128
		ACT-FLL-033	852	AD-0696-N3-00	174	DM-0064-N3-00	128
		ACT-FLL-036	853	AD-0697-N3-00	176	DM-0081-14-00	130
		ACT-FLL-037	853	AD-0698-14-00	176	DM-0081-60-00	130
		ACT-FLL-038	853	AD-0698-N3-00	176	DM-0082-14-00	130
		ACT-FLL-039	853	AD-0699-N3-00	176	DM-0082-60-00	130
		ACT-FLL-040	853	AD-0700-N3-00	176	DM-0083-14-00	130
		ACT-FLL-041	853	AD-0701-14-00	176	DM-0083-60-00	130
				AD-0701-N3-00	176	DM-0084-14-00	130

Reference	Page
DM-0084-60-00	130
DM-0093-14-00	131
DM-0093-60-00	131
DM-0094-14-00	131
DM-0094-60-00	131
DM-0095-14-00	131
DM-0095-60-00	131
DM-0096-14-00	131
DM-0096-60-00	131
DM-1100-14-00	133
DM-1100-60-00	133
DM-1100-N3-00	133
DM-1101-14-00	134
DM-1101-60-00	134
DM-1101-N3-00	134
DM-1102-14-00	134
DM-1102-60-00	134
DM-1102-N3-00	134
DM-1103-14-00	135
DM-1103-60-00	135
DM-1103-N3-00	135
DM-1105-N3-00	93
DM-1106-N3-00	93
DM-1107-14-00	91
DM-1107-N3-00	91
DM-1150-14-00	133
DM-1150-60-00	133
DM-1150-N3-00	133
DM-1151-14-00	133
DM-1151-60-00	133
DM-1151-N3-00	133
DM-1155-14-00	128
DM-1155-N3-00	128
DM-1156-14-00	128
DM-1156-N3-00	128
DM-1157-14-00	128
DM-1157-N3-00	128
DM-1158-14-00	128
DM-1158-N3-00	128
DM-1159-14-00	130
DM-1159-60-00	130
DM-1160-14-00	130
DM-1160-60-00	130
DM-1161-14-00	130
DM-1161-60-00	130
DM-1162-14-00	130
DM-1162-60-00	130
DN-0269-14-00	119
DN-0269-N3-00	119
DN-0270-14-00	118
DN-0270-N3-00	118
DN-0273-14-00	118
DN-0273-N3-00	118
DN-0274-14-00	118
DN-0274-N3-00	118
DN-0275-14-00	118
DN-0275-N3-00	118
DN-0276-N3-B9	167
DN-0289-N3-00	194
DN-0290-N3-00	194
DN-0472-S2-00	193
DN-0511-S2-00	193
DN-0512-N3-00	193
DN-0520-14-00	103

Reference	Page
DN-0520-N3-00	103
DN-0520-S2-00	103
DN-0521-14-00	102
DN-0521-N3-00	102
DN-0521-S2-00	102
DN-0522-14-00	102
DN-0522-N3-00	102
DN-0525-14-00	102
DN-0525-S2-00	102
DN-0526-14-00	102
DN-0526-S2-00	102
DN-0527-14-00	103
DN-0527-S2-00	103
DN-0610-14-00	103
DN-0610-N3-00	103
DN-0750-N3-B9	167
DN-1003-14-B9	106
DN-1003-N3-B9	106
DN-1003-S2-B9	106
DN-1009-14-B9	106
DN-1009-N3-B9	106
DN-1009-S2-B9	106
DN-1012-14-B9	106
DN-1012-S2-B9	106
DN-1016-14-B9	106
DN-1016-S2-B9	106
DN-1301-14-00	108
DN-1301-J2-00	108
DN-1302-14-00	108
DN-1302-J2-00	108
DN-1303-14-00	109
DN-1303-J2-00	109
DN-1304-14-00	109
DN-1304-J2-00	109
DN-1305-14-00	108
DN-1305-J2-00	108
DN-1400-14-00	152
DN-1400-N3-00	152
DN-1401-14-00	152
DN-1401-N3-00	152
DN-1402-14-00	152
DN-1402-N3-00	152
DN-1403-14-00	152
DN-1403-N3-00	152
DN-1405-14-00	152
DN-1405-N3-00	152
DN-1406-14-00	152
DN-1406-N3-00	152
DN-1407-14-00	152
DN-1407-N3-00	152
DN-1408-14-00	152
DN-1408-N3-00	152
DN-1409-14-00	152
DN-1409-N3-00	152
DN-1410-14-00	152
DN-1410-N3-00	152
DN-1600-14-00	89
DN-1601-14-00	89
DN-1602-14-00	89
DN-1603-14-00	89
DN-1620-14-00	162
DN-1640-14-T2	107
DN-1640-60-T2	107

Reference	Page
DN-1640-N3-T2	107
DN-1640-S2-T2	107
DN-1641-14-T2	107
DN-1641-60-T2	107
DN-1641-N3-T2	107
DN-1641-S2-T2	107
DN-1643-14-T2	107
DN-1643-60-T2	107
DN-1643-N3-T2	107
DN-1643-S2-T2	107
DN-1644-14-T2	107
DN-1644-60-T2	107
DN-1644-N3-T2	107
DN-1644-S2-T2	107
DN-1650-14-00	108
DN-1650-J2-00	108
DN-1651-14-00	89
DN-1652-14-00	118
DN-1652-N3-00	118
DN-1653-14-00	118
DN-1653-N3-00	118
DN-1662-14-00	164
DN-1663-14-00	164
DN-1666-14-00	164
DN-1667-14-00	164
DN-1680-14-00	150
DN-1695-14-00	94
DN-1695-S2-00	94
DN-1696-14-00	94
DN-1696-S2-00	94
DN-1697-14-00	95
DN-1697-S2-00	95
DN-1698-14-00	95
DN-1698-S2-00	95
EP-0344-N3-XY	207
EP-0345-N3-00	207
EP-0346-N3-XY	207
EP-0347-N3-00	207
EP-0348-14-XY	205
EP-0348-N3-XY	205
EP-0349-14-XY	205
EP-0349-N3-XY	205
EP-0356-14-00	205
EP-0356-N3-00	205
EP-0506-00-B9	194
EP-1615-14-00	178
EP-1617-14-00	174
EP-1618-14-00	174
EP-1619-14-00	174
EP-1620-14-00	174
EP-1621-14-00	174
EP-1622-14-00	174
EP-1623-14-00	176
EP-1624-14-00	176
EP-1625-14-00	176
EP-1626-14-00	176
EP-1627-14-00	176
EP-1640-14-00	174
EP-1641-14-00	174
EP-1642-14-00	174
EP-1643-14-00	174
EP-1644-14-00	174
EP-1645-14-00	174
EP-1646-14-00	176

Reference	Page
EP-1647-14-00	176
EP-1648-14-00	176
EP-1649-14-00	176
EP-1650-14-00	176
EP-1651-14-00	174
EP-1652-14-00	174
EP-1653-14-00	174
EP-1654-14-00	174
EP-1655-14-00	174
EP-1656-14-00	174
EP-1657-14-00	176
EP-1658-14-00	176
EP-1659-14-00	176
EP-1660-14-00	176
EP-1661-14-00	176
EP-1665-14-XY	205
ID-4	844
ID-5	844
ID-6	844
ID-10	845
ID-762	845
LT-20	843
NO-1	838
NO-2	838
NO-3	838
NO-4	839
NO-5	839
NO-6	839
NO-7	839
OC-12	840
OC-1875	840
OC-3125-A	841
OC-3125-B	841
OD-10	842
OD-16	842
OD-20	842
PAN-146-20	476
PAN-146-AJ	476
PAN-151-20	324
PAN-153-20	323
PAN-155-20	325
PAN-157-14	272
PAN-157-BY	272
PAN-158-J6	272
PAN-159-14	272
PAN-159-BY	272
PAN-160-J6	272
PAN-161-14	272
PAN-161-BY	272
PAN-162-J6	272
PAN-166-20	321
PAN-169-14	272
PAN-175-14	272
PAN-175-BY	272
PAN-176-14	272
PAN-176-BY	272
PAN-177-14	272
PAN-177-BY	272
PAN-178-14	272
PAN-178-BY	272
PAN-179-14	272
PAN-179-BY	272
PAN-180-14	272
PAN-180-BY	272

Reference	Page
PAN-181-14	272
PAN-181-BY	272
PAN-182-14	272
PAN-182-BY	272
PAN-182-T001	272
PAN-183-14	272
PAN-183-BY	272
PAN-183-T001	272
PAN-184-14	272
PAN-184-BY	272
PAN-185-J6	272
PAN-186-20	272
PAN-187-20	272
PAN-189-20	272
PAN-194-AJ	272
PAN-198-V7	272
PAN-199-V7	272
PAN-219-05	272
PAN-219-14	272
PAN-220-V7	272
PAN-221-V7	272
PR-0019-N3-00	74
PR-0020-N3-00	74
PR-0382-N3-00	75
PR-0383-N3-00	75
PR-0384-N3-00	75
PR-0385-N3-00	75
PR-0915-14-00	63
PR-0915-60-00	63
PR-0915-N3-00	63
PR-0916-14-00	63
PR-0916-60-00	63
PR-0916-N3-00	63
PR-0917-14-00	63
PR-0917-60-00	63
PR-0917-N3-00	63
PR-0918-14-00	63
PR-0918-60-00	63
PR-0918-N3-00	63
PR-0919-14-00	63
PR-0919-60-00	63
PR-0919-N3-00	63
PR-0920-14-00	63
PR-0920-60-00	63
PR-0920-N3-00	63
PR-0921-14-00	63
PR-0921-60-00	63
PR-0921-N3-00	63
PR-0922-14-00	63
PR-0922-60-00	63
PR-0922-N3-00	63
PR-0923-14-00	63
PR-0923-60-00	63
PR-0923-N3-00	63
PR-0924-14-00	65
PR-0924-60-00	65
PR-0924-N3-00	65
PR-0925-14-00	65
PR-0925-60-00	65
PR-0925-N3-00	65
PR-0926-14-00	65
PR-0926-60-00	65
PR-0926-N3-00	65
PR-0927-14-00	65

Reference	Page
PR-0927-60-00	65
PR-0927-N3-00	65
PR-0928-14-00	65
PR-0928-60-00	65
PR-0928-N3-00	65
PR-0929-14-00	65
PR-0929-60-00	65
PR-0929-N3-00	65
PR-0930-14-00	65
PR-0930-60-00	65
PR-0930-N3-00	65
PR-0931-14-00	65
PR-0931-60-00	65
PR-0931-N3-00	65
PR-0932-14-00	65
PR-0932-60-00	65
PR-0932-N3-00	65
PR-0936-N3-00	75
PR-0937-N3-00	75
PR-0940-14-00	63
PR-0940-60-00	63
PR-0940-N3-00	63
PR-0941-14-00	65
PR-0941-60-00	65
PR-0941-N3-00	65
PR-0944-N3-00	74
PR-0945-N3-00	74
PR-0946-14-00	70
PR-0946-60-00	70
PR-0947-14-00	70
PR-0947-60-00	70
PR-0948-14-00	70
PR-0948-60-00	70
PR-0949-14-37	70
PR-0949-60-37	70
PR-0950-14-37	70
PR-0950-60-37	70
PR-0951-14-37	70
PR-0951-60-37	70
PR-0952-14-37	70
PR-0952-60-37	70
PR-0953-14-37	70
PR-0953-60-37	70
PR-0954-14-37	70
PR-0954-60-37	70
PR-0955-14-00	70
PR-0955-60-00	70
PR-0956-14-37	71
PR-0956-60-37	71
PR-0957-14-37	71
PR-0957-60-37	71
PR-0958-14-37	71
PR-0958-60-37	71
PR-0959-14-37	71
PR-0959-60-37	71
PR-0960-14-37	71
PR-0960-60-37	71
PR-0961-14-37	71
PR-0961-60-37	71
PR-0975-14-00	64
PR-0975-60-00	64
PR-0975-N3-00	64
PR-0976-14-00	64
PR-0976-60-00	64

Reference	Page
PR-0976-N3-00	64
PR-0977-14-00	64
PR-0977-60-00	64
PR-0977-N3-00	64
PR-0978-14-00	64
PR-0978-60-00	64
PR-0978-N3-00	64
PR-0979-14-00	64
PR-0979-60-00	64
PR-0979-N3-00	64
PR-0980-14-00	64
PR-0980-60-00	64
PR-0980-N3-00	64
PR-0981-14-00	64
PR-0981-60-00	64
PR-0981-N3-00	64
PR-0982-14-00	64
PR-0982-60-00	64
PR-0982-N3-00	64
PR-0983-14-00	64
PR-0983-60-00	64
PR-0983-N3-00	64
PR-0984-14-00	64
PR-0984-60-00	64
PR-0984-N3-00	64
PR-0985-14-00	64
PR-0985-60-00	64
PR-0985-N3-00	64
PR-0986-14-00	64
PR-0986-60-00	64
PR-0986-N3-00	64
PR-0987-14-00	64
PR-0987-60-00	64
PR-0987-N3-00	64
SP-0105-N3-00	183
SP-1810-N3-00	183

IMPORTANT INFORMATION

- Todos los derechos reservados. Ninguna parte de este libro puede ser reproducida en ningún formato de papel o electrónico, sin el consentimiento previo del editor o de los propietarios de los derechos.
- All rights reserved. No part of this publication may be reproduced or transmitted in any form or by any means, electronic storage and retrieval system, without permission in writing from the copyright owner(s).
- Tous droits réservés. Aucune partie de ce livre ne pourra être reproduite en format papier ou électronique sans l'autorisation préalable de l'éditeur ou du propriétaire des droits.
- Sämtliche Rechte vorbehalten. Kein Teil dieses Buches darf weder in Papier- oder elektronischem Format ohne ausdrückliche Zustimmung des Herausgebers oder der Inhaber der Urheberrechte wiedergegeben oder vervielfältigt werden.
- Tutti i diritti riservati. Nessuna parte di questo catalogo può essere riprodotta in nessun formato cartaceo o elettronico, senza la previa autorizzazione dell'editore o dei proprietari dei diritti.
- Todos os direitos reservados. Nenhuma parte deste livro pode ser reproduzida em qualquer formato de papel ou electrónico, sem o consentimento prévio do editor ou dos proprietários dos direitos.
- Все права защищены. Запрещено использование любого материала из данного каталога без специального разрешения носителя прав собственности.
- Wszelkie prawa zastrzeżone. Żadna część tej publikacji nie może być kopiowana lub transmitowana w jakiegokolwiek formie lub w jakikolwiek sposób przechowywana elektronicznie bez pisemnego pozwolenia posiadacza praw autorskich.

Debido a la constante evolución tecnológica del LED, los productos que incluyen esta fuente de luz pueden experimentar variaciones en sus características técnicas con el objetivo de poder ofrecer siempre las máximas prestaciones en nuestros productos.

Due to the constant evolution of LED technology, those products which contain this light source can vary in their technical characteristics so as to ensure that we can always offer maximum product performance.

En raison de l'évolution constante de la technologie LED, les produits dotés de cette source lumineuse peuvent connaître des variations dans leurs caractéristiques techniques, en vue de toujours en optimiser les prestations.

Aufgrund der kontinuierlichen Fortschritte bei der LED-Technik, mit denen wir sicherstellen, dass wir stets Artikel auf dem neusten Stand der Technik liefern, können sich die Merkmale der Produkte dieser Lichtquelle ändern.

A causa della costante evoluzione tecnologica del LED, i prodotti che contengono questa fonte di luce possono subire variazioni nelle loro caratteristiche tecniche con l'obiettivo di offrire sempre massime prestazioni.

Devido à constante evolução tecnológica do LED, os produtos que incluem esta fonte de luz podem apresentar variações nas suas características técnicas com o objetivo de garantir sempre o máximo desempenho dos nossos produtos.

В силу постоянного технологического прогресса в области производства светодиодов, технические характеристики нашей продукции, в которой используется этот источник света, могут претерпевать изменения, всегда с целью обеспечения наилучших потребительских свойств..

Z uwagi na ciągły rozwój technologiczny LED, produkty które zawierają to źródło światła mogą ulegać zmianom pod względem właściwości technicznych, tak aby móc zawsze oferować maksymalną ilość świadczeń w naszych produktach.

OTHER LEDS-C4 CATALOGUES



DISEÑO CONTEMPORÁNEO
CONTEMPORARY DESIGN
DESIGN CONTEMPORAIN
ZEITGENÖSSISCHES DESIGN
DESIGN CONTEMPORANEO
DESIGN CONTEMPORÁNEO
СОВРЕМЕННЫЙ ДИЗАЙН
WSPÓŁCZESNY DESIGN

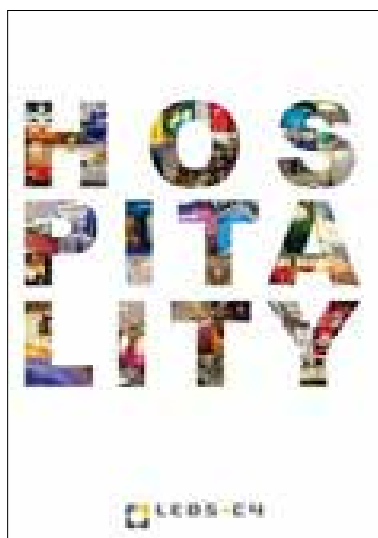

ILUMINACIÓN PARA HOTELES
HOTEL LIGHTING
ÉCLAIRAGE HÔTELIER
HOTELBELEUCHTUNG
ILLUMINAZIONE PER HOTEL
ILUMINAÇÃO PARA HOTÉIS
ОСВЕЩЕНИЕ ДЛЯ ОТЕЛЕЙ
OŚWIETLENIE DLA HOTELI



ILUMINACIÓN COMERCIAL
COMMERCIAL LIGHTING
ÉCLAIRAGE COMMERCIAL
SHOPBELEUCHTUNG
ILLUMINAZIONE COMMERCIALE
ILUMINAÇÃO COMERCIAL
ОСВЕЩЕНИЕ ДЛЯ ТОРГОВЫХ ПОМЕЩЕНИЙ
OŚWIETLENIE HANDLOWE

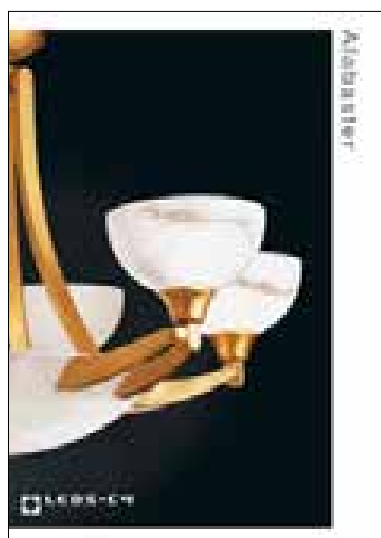

ALABASTRO COMO DIFUSOR
ALABASTER DIFFUSOR
ALBÂTRE EN TANT QUE DIFFUSEUR
ALABASTER ALS DIFFUSOR
ALABASTRO COME DIFFUSORE
ALABASTRO COMO DIFUSOR
АЛЕБАСТР В КАЧЕСТВЕ РАССЕИВАТЕЛЯ
ALABASTER JAKO DYFUZOR

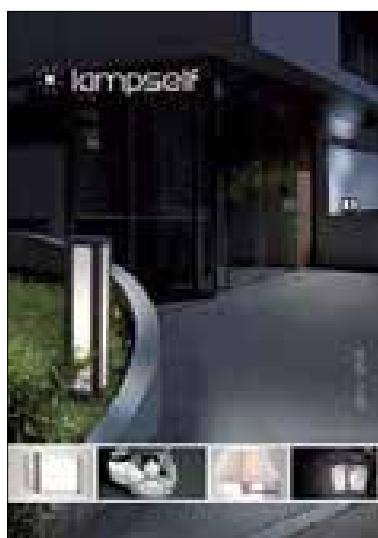

LUMINARIAS PARA CANAL DIY
LUMINAIRES FOR THE DIY CHANNEL
LUMINAIRES POUR LE CANAL DIY
LEUCHTEN FÜR BAUMÄRKTE
LUCI PER CANALE DIY
LUMINÁRIAS PARA CANAL DIY
СВЕТИЛЬНИКИ ДЛЯ КАНАЛА DIY
OPRAWY OŚWIETLENIOWE DLA KANAŁU DIY

SYNERGIES WITH...



OFICINA
OFFICE
BUREAU
BÜRO
UFFICIO
ESCRITÓRIO
ОФИС
BIURO



MERCHANDISING
MERCHANDISING
MERCHANDISING
MERCHANDISING
MERCHANDISING
MERCHANDISING
РЕКЛАМНЫЕ МАТЕРИАЛЫ
MATERIAŁY REKLAMOWE



VILAGRASA



PAPERAS DE RECICLAJE
RECYCLING BINS
POUBELLES DE RECYCLAGE
WERTSTOFFCONTAINER
CESTINI
CONTENTORES RECICLAGEM DE PAPEL
УТИЛИЗАЦИОННЫЕ ВЕДРА
KOSZE NA ŚMIECI Z SUROWCÓW WTÓRNYCH

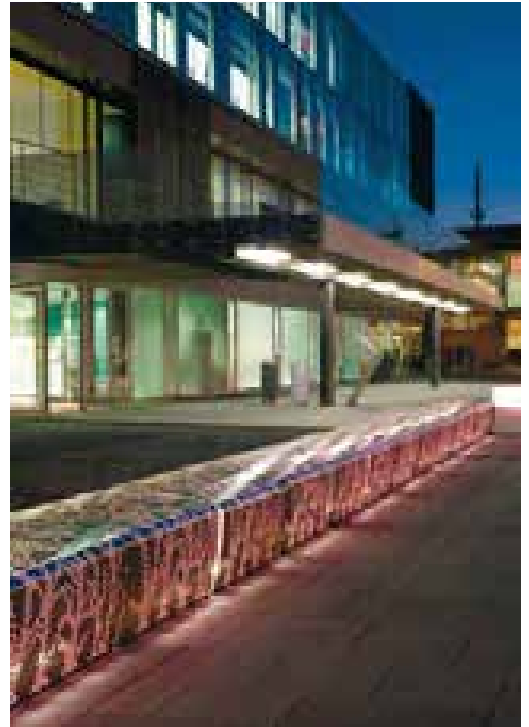

EXTERIOR
OUTDOOR
EXTÉRIEUR
AUSSEN
ESTERNI
EXTERIOR
ВНЕШНИЙ ВИД
ZEWNETRZNY

MÁS INFORMACIÓN EN
MORE INFORMATION AT
PLUS D'INFO SUR
WEITERE INFORMATION AUF
ULTERIORI INFORMAZIONI SU
MAIS INFORMACÕES EM
БОЛЕЕ ПОДРОБНАЯ ИНФОРМАЦИЯ НА
WIĘCEJ INFORMACJI NA
WWW.VILAGRASA.COM

CONTACT

LEDS-C4, S.A.

Afueras s/n
25750 Torà (Lleida)
SPAIN
www.leds-c4.com

ESPAÑA

Tel.: 973 468 101
Fax.: 973 468 129
e-mail: info@leds-c4.com

FRANCE

Tel.: + 34 973 468 130
Fax.: + 34 973 468 129
e-mail: france@leds-c4.com

PORTUGAL

Tel.: + 34 973 468 130
Fax.: + 34 973 468 129
e-mail: portugal@leds-c4.com

EUROPE

Tel.: + 34 973 468 102
Fax.: + 34 973 468 106
e-mail: europe@leds-c4.com

AMÉRICA LATINA

Tel.: + 34 973 468 115
Fax.: + 34 973 468 106
e-mail: sudamerica@leds-c4.com

USA - CANADA

Tel.: +34 973 468 109
Fax: +34 973 468 106
e-mail: lighting@leds-c4.com

ASIA - PACIFIC & AFRICA

Tel.: + 34 973 468 116
Fax.: + 34 973 468 106
e-mail: export@leds-c4.com

MIDDLE EAST COUNTRIES

Tel.: + 34 973 468 108
Fax.: + 34 973 468 106
e-mail: dep-export@leds-c4.com

