

# GROK

 LED S-C4

2013  
2014

ABS

ABS • ABS • ABS • ABS • ABS • ABS • ABS  
• ABS

PMMA

PMMA • PMMA • PMMA • PMMA • PMMA •  
PMMA • PMMA • PMMA

AL

Aluminio • Aluminium • Aluminium •  
Aluminium • Alluminio • Aluminio • Алюминий  
• Aluminium

GLASS  
BOSI

Vidrio de borosilicato • Borosilicate glass •  
Verre borosilicaté • Borosilikatglas •  
Vetro borosilicato • Vidro de borosilicato •  
Боросиликатное стекло • Szko borokrzemianowe

GLASS  
MAT

Vidrio mate • Matt glass • Verre mat • Matter  
Glas • Bicchiere mat • Vidro mate • Матовое  
стекло • Szko matowe

GLASS  
OPAL3

Cristal opal triplex • Triplex Opal glass • Verre  
opal triplex • Optishes Glas • Vetro ottico  
• Cristal opala triplo • Стекло опаловый  
триплекс • Trójwarstwowe szkło opalowe

GLASS  
OPT

Cristal óptico • Optic glass • Verre optique •  
Optishes Glas • Vetro ottico • Cristal óptico •  
Оптическое стекло • Szko optyczne

GLASS  
TRANS

Cristal transparente • Transparent glass •  
Verre transparent • Transparenter Glas •  
Bicchiere transparente • Cristal transparente •  
Прозрачное стекло • Przezroczyste szkło

PC

Policarbonato • Polycarbonate •  
Polycarbonate • Polykarbonat • Policarbonato  
• Policarbonato • Поликарбонат • Poliwęglan

PE

Polietileno • Polyethylene • Polyéthylène  
• Polyethylen • Polietileno • Polietileno •  
Полиэтилен • Polietylen

PS

Poliestireno • Polystyrene • Polystyrène  
• Polystyrol • Polistirolo • Poliestireno •  
Рассеиватель • Polistyren

PUR

Poliuretano • Polyurethane • Polyuréthane  
• Polyurethan • Poliuretano • Poliuretano •  
Поулиритан • Poliuretan

PVC

PVC • PVC • PVC • PVC • PVC • PVC • PVC  
• PVC

SIL

Silicona • Silicone • Silicone • Silikon • Silicone  
• Silicone • Силикон • Silikon

ST

Acero • Steel • Acier • Stahl • Acciaio • Aço  
• Сталь • Stal

TEX  
TIL

Tela • Fabric • Tissu • Stoff • Tela • Tela •  
Ткань • Tkanina

ZAMAK

Zamak • Zamak • Zamak • Zamak • Zamak •  
Zamak • Zamak • Zamak

03

T002

Gris • Grey • Gris • Grau • Grigio • Cinzento •  
Серый • Szary

05

Negro • Black • Noir • Schwarz • Nero • Preto  
• Черный • Czarny

14

T003

Blanco • White • Blanc • Weiß • Bianco •  
Branco • Белый • Biały

12

Difusor acrílico fumé • Smoked acrylic diffu-  
ser • Diffuseur acrylique fumé • Acryldiffusor  
geräuchert • Diffusore in acrilico fumé • Difusor  
acrílico fumado • Акриловый рассеиватель  
из коричневого стекла • Zadymiony dyfuzor  
akrylowy

20

BY

Beige • Beige • Beige • Beige • Beige • Bege  
• Бежевый • Bez

21

Cromo • Chrome • Chrome • Chrom • Cromo  
• Cromo • Хром • Chromowany

23

Dorado • Golden • Doré • Golden • Oro •  
Dourado • Позолоченный • Złoty

25

Rojo • Red • Rouge • Rot • Rosso • Vermelho  
• Красный • Czerwony

78

Lacado blanco • White lacquered • Laqué  
en blanc • Weiß lackiert • Laccato bianco •  
Lacado branco • Белый лак • Polakierowany  
na bialo

81

Níquel satinado • Satin nickel • Nickel satiné •  
Nickel satiniert • Nichel satinato •  
Níquel acetinado • Сатинированный никель •  
Szczotkowany nikiel

AH

Aluminio ecobright • Ecobright aluminium •  
Aluminium Ecobright • Aluminium Ecobright  
• Alluminio ecobright • Aluminio ecobright •  
Алюминий Экобрайт • Aluminium ecobright

AF

S2

Y6

Aluminio satinado • Satin aluminium • Alumi-  
nium satiné • Aluminium matt • Aluminio sati-  
nato • Aluminio acetinado • Сатинированный  
алюминий • Aluminium satynowe

AG

Aluminio con cromo • Aluminium with chrome  
• Aluminium avec chrome • Aluminium mit  
Chrom • Alluminio con cromo • Aluminio con  
cromo • Алюминий с хромом • Aluminium z  
chromem

AJ

Gris Ópera • Opera grey • Gris opéra • Opera  
grau • Grigio • Gris opera • Серебрянный  
шелк • Opera szary

AQ

Gris metalizado • Metallic grey • Gris métallisé  
• Metallisch-grau • Grigio metallizzato • Cinza  
metalizado • Серый металл • Metaliczny szary

AQ

Pantalla interior plisada plata • Silver pleated  
interior shade • Intérieur d'abat-jour plissé  
argenté • Innenseite silber Plissee • Paralume  
interna plisada argento • Abat-jour interior  
plissado prateado • Внутренний  
гафрированный плафон серебряного цвета  
• Srebrny abażur wewnętrzny z zakładkami

AP

Pantalla interior plisada dorada • Golden  
pleated interior shade • Intérieur d'abat-jour  
plissé doré • Innenseite gold Plissee •  
Paralume interna plisada oro • Abat-jour  
interior plissado dourado • Внутренний  
гафрированный плафон цвета позолоты •  
Złoty abażur wewnętrzny z zakładkami

BW

Blanco mate • Matt white • Blanc mate • Weiß  
matt • Bianco opaco • Branco fosco • Белый  
матовый • Matowy biały

D8

Pan de Oro • Golden leaf • Feuille d'or •  
Blattgold • Foglia di oro • Capa de ouro  
сусальное золото • Złoto platkowe

D9

Pan de plata • Silver leaf • Feuille d'argent •  
Blattsilber • Foglia argento • Capa de prata •  
Сусальное серебро • Srebro platkowe

N3

Gris textura • Grey texture • Gris à effet de  
texture • Grau matt • Grigio • Cinzento textura  
• Текстурный серый • Szary tekstury

N4

Gris textura con cromo • Grey texture with  
chrome • Gris à effet de texture avec chrome  
• Grau rauh-matt mit Chrom • Grigio rugoso  
con cromo • Cinzento textura com cromo •  
Текстурный серый с хромом • Szara tekstura  
z chromem

S3

Aluminio pulido y satinado • Polished and  
burnished aluminium • Aluminium poli et  
satiné • Aluminium poliert und mattglänzend •  
Alluminio lucidato e satinato • Aluminio pulido  
e acetinado • Полированный сатиновый  
алюминий • Polerowane i satynowane  
aluminium

U4

Níquel satinado pintado • Painted satin nickel  
• Nickel satiné peint • Nickel satiniert gestrichen  
• Nichel satinato dipinto • Níquel acetinado  
pintado • Отделка сатиновый никель •  
Satynowany nikiel malowany

Y5

Aluminio mate • Matt aluminium • Aluminium  
mat • Aluminium matt • Alluminio opaco •  
Aluminio mate • Матовый алюминий • Ma-  
towe aluminium



**GROK**

---

# EXPERIENCE & KNOW-HOW

LEDS-C4 es una empresa con más de 40 años de experiencia en el diseño, desarrollo y producción de aparatos de iluminación.

LEDS-C4 is a company with over 40 years' experience in design, development and manufacture of lighting solutions.

LEDS-C4 est une société forte de plus de 40 ans d'expérience en conception, développement et fabrication de solutions d'éclairage.

LEDS-C4 ist eine Firma mit über 40 Jahren Erfahrung im Design, Entwicklung und Herstellung von Lichtlösungen.

LEDS-C4 e' un'azienda con oltre quaranta anni di esperienza nel settore dell'illuminazione, specializzata nello sviluppo dei prodotti, progettazione e soluzioni illuminotecniche.

A LEDS-C4 é uma empresa com mais de 40 anos de experiência em design, desenvolvimento e fabrico de soluções de iluminação.

LEDS-C4 – это компания с более, чем сорокалетним опытом работы в дизайне и производстве светильников.

LEDS-C4 to firma z ponad 40-letnim doświadczeniem w rozwoju, projektowaniu i produkcji rozwiązań oświetleniowych.



BESPOKE SOLUTIONS  
Saint Regis hotel – Doha (Qatar)



INTEGRAL LIGHTING EXPERIENCE  
Crowne Plaza hotel – Liège (Belgium)







TERTIARY LIGHTING

Cultural Center of Telecom – Sto Domingo (Dominican Rep)



HOSPITALITY LIGHTING

The Hotel – Brussels (Belgium)



SHOP LIGHTING

Sita Murt shop – Barcelona (Spain)



INDOOR LIGHTING

Renaissance Tuscany Il Ciocco Res & Spa – Barga (Italy)



OUTDOOR LIGHTING

Las Arenas shopping center – Barcelona (Spain)



URBAN LIGHTING

Metropol Parasol market – Sevilla (Spain)

CONSULTORÍA DE ILUMINACIÓN  
 LIGHTING CONSULTANCY  
 LE CONSEIL EN ILLUMINATION  
 CONSULENZA DI ILLUMINAZIONE  
 ABTEILUNG FÜR BELEUCHTUNGSBERATUNG  
 CONSULTORIA DE ILUMINAÇÃO  
 КОНСУЛЬТАЦІЯ ПО ОСВЕЩЕНІЮ  
 DORADZTWO OŚWIETLENIOWE

DIALUX



---

# Designers

---

	<p><b>Jantze, Brogård &amp; Asshoff Design</b></p>	<p>We beautify and simplify our surroundings to improve the everyday life. Embellecemos y simplificamos nuestro entorno para mejorar el día a día</p>
	<p><b>Estudi Ribaudí</b></p>	<p>We work in a world where ideas are born, make them grow and transform them into objects. Trabajamos en el mundo donde nacen las ideas, las hacemos crecer y las transformamos en objetos</p>
	<p><b>Benedito Design</b></p>	<p>The use of beauty La utilidad de la belleza</p>
	<p><b>Josep Patsí</b></p>	<p>When art and technique come together. Cuando arte y técnica se encuentran.</p>
	<p><b>Francesc Vilaró</b></p>	<p>Moulding the light allows us to design the context creating unique spaces and environments. Modelar la luz nos permite diseñar el contexto creando espacios y ambientes únicos.</p>
	<p><b>WIS Design</b></p>	<p>Wisdom and poetry for everyday objects. Sabiduría y poesía para los objetos cotidianos.</p>
	<p><b>Nahtrang disseny</b></p>	<p>Working with light is a challenge. Obtaining a great result is magic. Trabajar la luz es un reto. Obtener un buen resultado es mágico.</p>
	<p><b>Gemma Bernal</b></p>	<p>As a designer I tend to propose useful, simple and warm objects. Como diseñadora trato de proponer objetos útiles, simples y amables.</p>
	<p><b>Ramón Valls</b></p>	<p>A little bit more is always possible. Un poco más casi siempre es posible.</p>





---

# Index

---

/8

colgantes  
pendants  
suspensions  
pendelleuchten  
pendenti  
pendentes  
ПОДВЕСНЫЕ СВЕТИЛЬНИКИ  
lampy wiszące



*Adagio 60*



*Balloons 38*



*Blomma 40*



*Circ 34*



*Clear 26*



*Duna 68*



*Emy 46*



*Iris 44*



*Ledagio 58*



*Leila 76*



*Linear 69*



*Net 22*



*Ringofire 14*



*Shi 50*



*Siluet 52*



*Sky 54*



*Slimm 70*



*Spin 72*



*Tandem 18*



*Tempo 66*



*Troppo 64*



*Tulip 36*



*Twins 48*



*Umbrella 30*

appliques  
 wall fixtures  
 appliques  
 wandleuchten  
 lampade da parete  
 appliques  
 настенные светильники  
 lampy ścienne

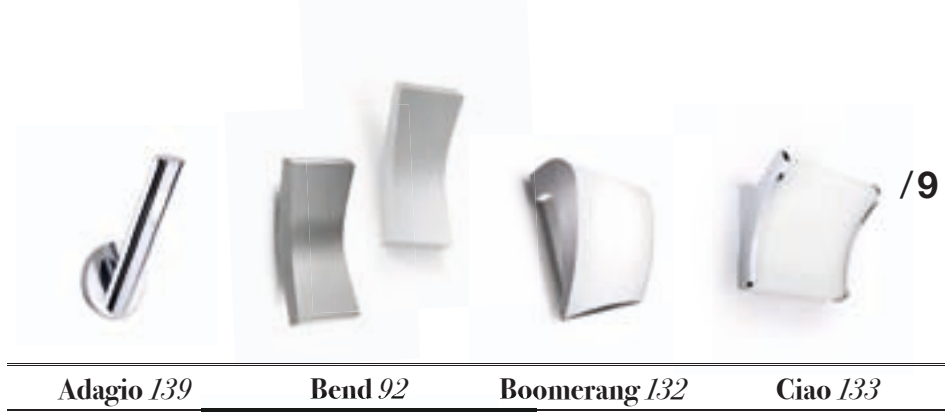

/9

*Adagio 139*

*Bend 92*

*Boomerang 132*

*Ciao 133*



*Duna 130*

*Emy 118*

*Flat 120*

*Hall 114*

*Hotels 112*



*Ibis 190*

*Ledbox 86*

*Level 138*

*Line 96*

*Lov 98*



*Mini 222*

*Mirror 122*

*Nemo 220*

*Open 104*

*Quattro 200*

*Rizz 82*



*Ska 208*

*Skata 124*

*Slight 202*

*Slimm 128*

*Suite 106*



*Suite 108*

*Supple 102*

*Traç 134*

/ 10

plafones  
ceiling fixtures  
plafoniers  
deckenleuchten  
plafoniere  
plafones  
ПОТОЛОЧНЫЕ СВЕТИЛЬНИКИ  
lampy sufitowe



*Ace 176*

*Adagio 196*

*Basic 206*

*Escher 194*



*Global 182*

*Hat 218*

*Ibis 190*

*Ledbox 224*

*Mini 222*

*Moon 188*



*Nemo 220*

*Net 184*

*Ocho 210*

*Ona 198*

*Petra 216*

*Quattro 200*



*Ska 208*

*Slight 202*

*Spin 212*

*Square 204*

*Six 168*



*Tandem 172*

*Traç 186*

*Troppo 192*

sobremesas  
table lamps  
lampes de table  
tischleuchten  
lampade da tavolo  
candeeiros de mesa  
НАСТОЛЬНЫЕ СВЕТИЛЬНИКИ  
lampy biurkowe



*Blomma 146*

*Bonne nuit 164*

*Emy 162*



*Iris 148*

*Medusa 142*

*Office 156*

*Open 154*

*Suite 158*





Suite 160



Supple 152



Sway 150

pies salón  
floor lamps  
lampadaires  
stehleuchten  
lampade da terra  
candeeiros de sala  
торшеры  
lampy podłogowe



Adagio  
268



Arc  
266



Blomma  
248



Bosquet  
232



Emy  
252



Everyday outdoor  
244



Hoop  
240



Hoop balloons  
236



Iris  
250



Kubik  
264



Leila  
256



Medusa  
228



Open  
260



Suite  
258



Suite  
259



Supple  
262



Totem  
270

lâmparas  
lamps  
lampes  
lampen  
lampadine  
lâmpadas  
лампы  
lampa

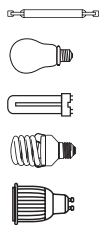

Lamps  
274

---

# Pendants

---

	<b>Ringofire</b> <i>p.14</i>		<b>Shi</b> <i>p.50</i>
	<b>Tandem</b> <i>p.18</i>		<b>Siluet</b> <i>p.52</i>
	<b>Net</b> <i>p.22</i>		<b>Sky</b> <i>p.54</i>
	<b>Clear</b> <i>p.26</i>		<b>Ledagio</b> <i>p.58</i>
	<b>Umbrella</b> <i>p.30</i>		<b>Adagio</b> <i>p.60</i>
	<b>Circ</b> <i>p.34</i>		<b>Troppo</b> <i>p.64</i>
	<b>Tulip</b> <i>p.36</i>		<b>Tempo</b> <i>p.66</i>
	<b>Balloons</b> <i>p.38</i>		<b>Duna</b> <i>p.68</i>
	<b>Blomma</b> <i>p.40</i>		<b>Linear</b> <i>p.69</i>
	<b>Iris</b> <i>p.44</i>		<b>Slimm</b> <i>p.70</i>
	<b>Emy</b> <i>p.46</i>		<b>Spin</b> <i>p.72</i>
	<b>Twins</b> <i>p.48</i>		<b>Leila</b> <i>p.76</i>

/14

# Ringofire<sup>new</sup>

---

*design* Francesc Vilaró

---







# Ringofire



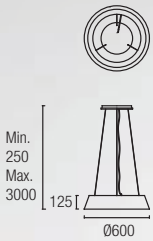

**00-0053-05-BW**

LED 26W  
3000K included

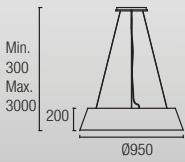

**00-0054-05-BW**

LED 41W  
3000K included

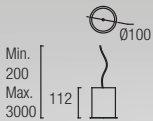

**71-0053-BW-BW**

1 x GU10 Max. 15W / Max. L= 100mm

Ø=111mm LED

**Recommended:**

**ACT-FLL-015 10W 24°**

**ACT-FLL-017 10W 35°**

**ACT-FLL-032 15W 24°**

**ACT-FLL-033 15W 35°**



Sistema de doble iluminación independiente  
Independent double lighting system  
Système double éclairage indépendant  
Unabhängiges doppeltes Beleuchtungssystem  
Sistema di doppia illuminazione indipendente  
Sistema de dupla iluminação independente  
Система независимого двойного освещения  
Niezależny system podwójnego oświetlenia







# Tandem<sup>new</sup>

---

*design* Benedito Design

---





# Tandem

/21

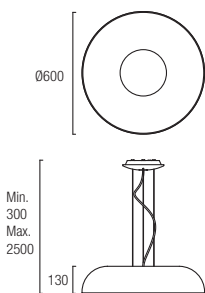

**00-0056-BW-M1 / 00-0056-05-M1** (Standard)  
**00-0678-BW-M1 / 00-0678-05-M1** (Dimmable 1-10V)  
 1 x 2GX13 40W + 1 x 2GX13 22W  
 2700K included

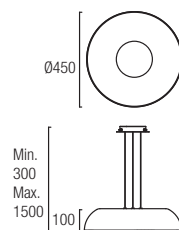

**00-0778-05-M1** (Standard) **new**  
**00-0778-BW-M1** (Standard)  
 1 x 2GX13 55W  
 2700K included

05 BW

ST PMMA  
 DIF





/22

# Net

*design* Josep Patsí



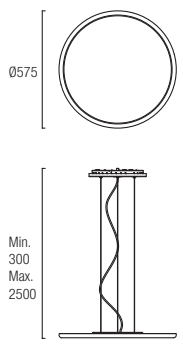

**00-0003-BW-M1** (Standard)  
**00-0643-BW-M1** (Dimmable 1-10V)

LED 44W  
 3000K included

**100** Lm/Watt **equivalente a**  
**3x60W E-27 Halogen**



**71-2241-00-00**



Controlador con mando a distancia para 00-0003  
 Controller with remote control for 00-0003



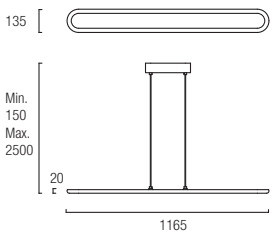

**00-0779-BW-M1** (Standard)  
**00-0826-BW-M1** (Dimmable 1-10V)

LED 43W  
 3000K included

**83** Lm/watt **equivalente a brighter as 9x20W G9 ECO Halogen**



**71-2241-00-00**

**new**

Controlador con mando a distancia para 00-0779  
 Controller with remote control for 00-0779







# Clear

*design Josep Patsí*

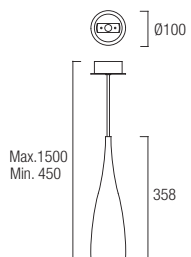

**00-2872-05-M2**  
**00-2872-78-M2**

1 x E-27 Max. 50W / Max. L=170mm Ø=60mm  
Halogen - Fluorescent - LED  
**Recommended E-27 PAR-20 50W**



**71-2232-14-14**

Conector de carril  
Track connector  
Connecteur de rail  
Schienenstecker  
Connettore di binario  
Conector de calha  
Трековый соединитель  
Złączka szyny



05 78

ST PC  
DIF









Clear

/29





# Umbrella

*design WIS design*







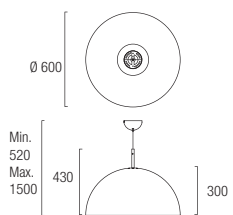

**00-2727-AP-05**  
**00-2727-AQ-78**

3 x E-14 Max. 11W / Max. L=145mm Ø=45mm  
Fluorescent - LED

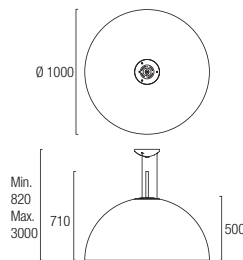

**00-2726-AP-05**  
**00-2726-AQ-78**

3 x E-27 Max. 23W / Max. L=150mm Ø=60mm  
Fluorescent - LED

05 AP 78 AQ

PMMA TEXTIL GLASS MAT DIF





# Umbrella



# Circ

*design Grok Team*



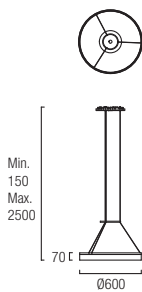

**00-0001-BW-M3** (Standard)  
**00-0641-BW-M3** (Dimmable 1-10V)

LED 22W  
 3000K included

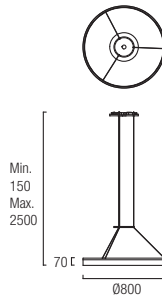

**00-0002-BW-M3** (Standard)  
**00-0642-BW-M3** (Dimmable 1-10V)

LED 31W  
 3000K included



**71-2241-00-00**



Controlador con mando a distancia para  
 00-0001 y 00-0002  
 Controller with remote control for 00-0001  
 and 00-0002





/36

# Tulip

---

*design* Estudi Ribaudí

---







Tulip es una lámpara de suspensión de morfología vegetal. Su diseño explora las formas orgánicas que produce la naturaleza sobre los seres vivos en crecimiento. La conexión en espiral de los pétalos que le dan forma crea una figura misteriosamente asimétrica, pero a la vez armónica y de aspecto natural.

Tulip is a hanging lamp with vegetable forms. Its design explores the organic shapes created by nature in growing, living beings. The spiral connection of the petals creates a figure which is mysteriously asymmetrical, but at the same time harmonious and natural-looking.

Tulip est une lampe en suspension à la morphologie végétale. Sa conception s'inspire des formes organiques que la nature engendre chez les êtres vivants en croissance. La connexion en spirale des pétales qui lui donnent forme crée une figure mystérieusement asymétrique, à la fois harmonieuse et d'aspect naturel.

Tulip ist eine Hängelampe im originellen Blumendesign. Ihre Form ahmt die natürlichen Formen der im Wachsen befindlichen Pflanzen nach. Die Spiralverbindung der Blütenblätter sorgt für eine asymmetrische und zugleich harmonische und natürlich anmutende Figur. Ein echter Blickfang!

Tulip è una lampada a sospensione di morfologia vegetale. Il suo design esplora le forme organiche prodotte dalla natura sugli esseri viventi in crescita. Il collegamento a spirale dei petali che le danno forma dà origine a una figura misteriosamente asimmetrica ma allo stesso tempo armonica e dall'aspetto naturale.

Tulip é uma luminária de suspensão cuja morfologia se inspira em formas vegetais. O seu design explora os aspectos orgânicos que a natureza produz sobre os seres vivos em crescimento. A ligação das pétalas em espiral, que lhe dão forma, cria uma figura misteriosamente assimétrica, mas ao mesmo tempo harmoniosa e de aspecto natural.

Tulip - это подвесной потолочный светильник, повторяющий растительную форму. Его дизайн отражает органические формы роста и развития, созданные самой природой. Спиральное расположение лепестков создает фигуру таинственно асимметричную, но, между тем, гармоничную и естественную.

Tulip to lampa wisząca z formami warzyw. Jej wzór czerpie z organicznych kształtów wykreowanych przez naturę w rosnących, żywych organizmach. Spiralne połączenia płatków tworzą tajemniczy, asymetryczny obraz, który jednocześnie posiada cechy zharmonizowanego o naturalnym wyglądzie.

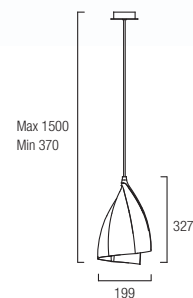

00-4416-05-23  
00-4416-78-03

1 x E-27 Max. 23W /  
Max. L=150mm Ø=60mm  
Fluorescent - LED  
**Recommended  
LED ACT-FLL-050**



71-2232-14-14

Conector de carril  
Track connector  
Connecteur de rail  
Schienenstecker  
Connettore di binario  
Conector de calha  
Трековый соединитель  
Złączka szyny

05 23 78 03

ABS





# Balloons

*design Josep Patsí*

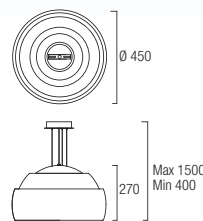

**00-4348-21-F9**

1 x E-27 Max. 150W / Max. L=195mm Ø=60mm  
Halogen - Fluorescent - LED  
**Recommended LED ACT-FLL-050**







# Blomma

---

*design WIS Design*

---





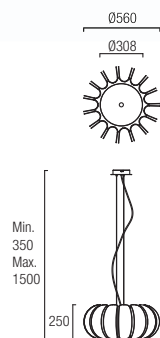

00-4391-BW-03  
00-4391-BW-05  
00-4391-BW-25

3 x E-27 Max. 23W / Max. L=140mm Ø=60mm  
Fluorescent - LED  
Recommended LED ACT-FLL-050



# Iris

*design Gemma Bernal*





21

ST PMMA PMMA  
DIF SHADE



149

251

0425

0328



00-4413-21-M2

1 x 2GX13 55W

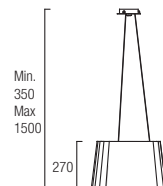



# Emy

*design* Francesc Vilaró

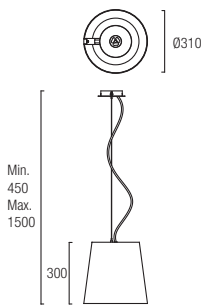

**00-4409-21-12**

1 x E-27 Max. 30W / Max. L=180mm Ø=60mm  
Fluorescent - LED  
Recommended LED ACT-FLL-050

21 12

AL PMMA PMMA  
DIF SHADE







# Twins

*design* **Benedito Design**

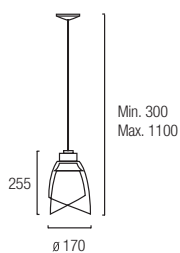

## 00-0087-N3-F9

1 x E-27 Max. 100W /  
Max. L=150mm Ø=60mm  
Halogen - Fluorescent - LED

**Recommended**  
**LED ACT-FLL-050**



## 71-2232-14-14

Conector de carril  
Track connector  
Connecteur de rail  
Schienenstecker  
Connettore di binario  
Conector de calha  
Трековый соединитель  
Złącza szyny

N3









# Shi

/51

*design Josep Patsí*

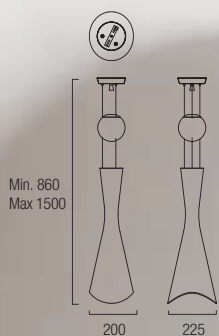

00-2725-Y5-14

1 x E-27 Max. 100W / Max. L=140mm Ø=120mm  
Halogen - Fluorescent - LED

**Recommended PL E-27 Globe 20W**

+ 1 x GU10 LED 5W included  
LED

included



Y5 14

ST GLASS  
OPAL3  
DIF



# Siluet



*design* **Benedito Design**

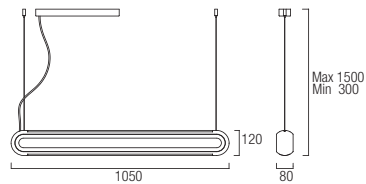
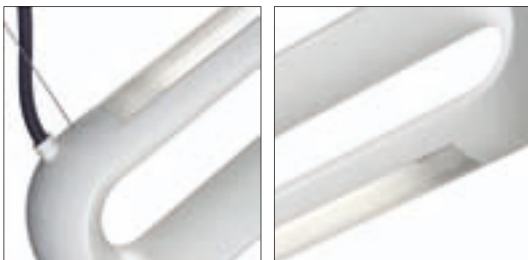

**00-2801-14-M3**

2 x T5 39W  
2700K included





# Sky

*design* Nahtrang Design







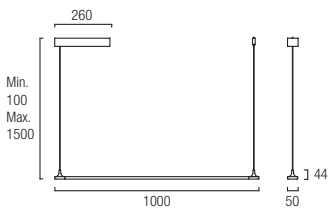

**00-0049-AH-AH**

(Dimmable 1-10V/PUSH/potentiometer 100Kohm)

**00-2392-AH-AH** (Phase cut dimming)

230V



18 LED x 1W CREE  
3000K included

**equivalente a  
brighter as**  
6x20W G9 ECO Halogen

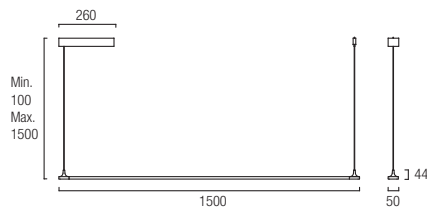

**00-0052-AH-AH** (Dimmable 1-10V)

27 LED x 1W CREE  
3000K included

**equivalente a  
brighter as**  
9x20W G9 ECO Halogen

AH

AL

ABS



RF

850

110

240V



CE



73,7

Lm/watt

Light



8

Sky

/57



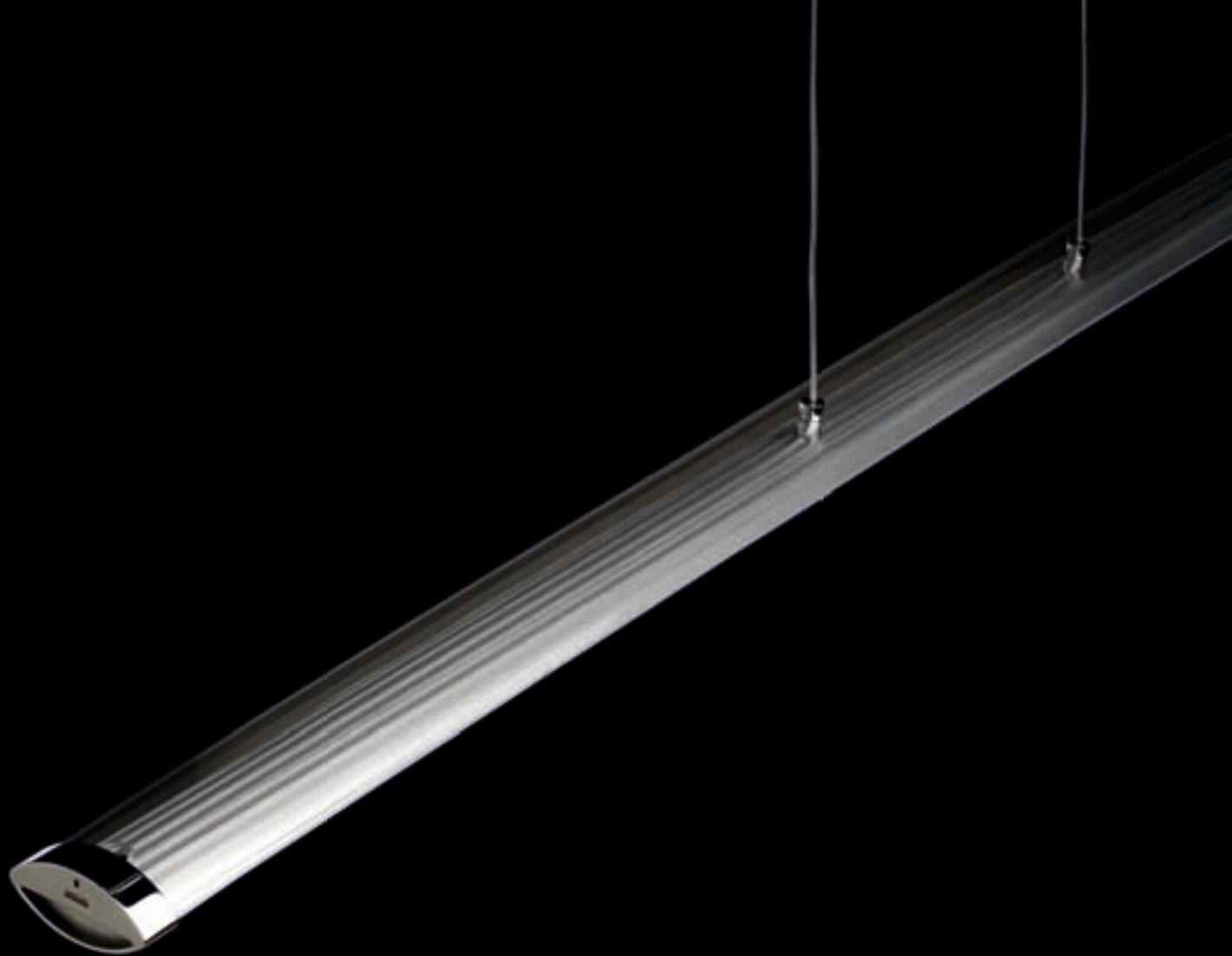

# Ledagio

---

*design Josep Patsí*

---



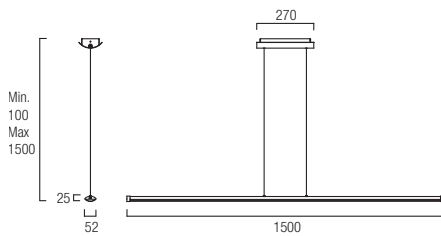

**00-4425-21-M3** (Standard)  
**00-0504-21-M3** (Dimmable 1-10V)

27 LED x 1W CREE  
 3000K included

**equivalente a  
 brighter as**  
 8x20W G9 ECO Halogen

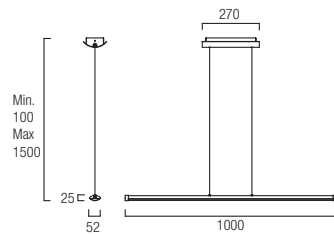

**00-4424-21-M3** (Standard)  
**00-0489-21-M3** (Dimmable 1-10V)  
**00-2403-21-M3** (Phase cut dimming)

18 LED x 1W CREE  
 3000K included

**equivalente a  
 brighter as**  
 5x20W G9 ECO Halogen



# Adagio

*design Josep Patsí*





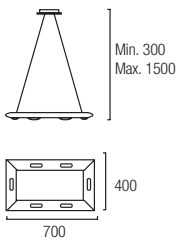

**20-0536-21-F1**

6 x G9 Max. 75W  
OSRAM included

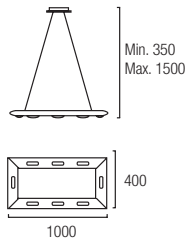

**20-0313-21-F1**

8 x G9 Max. 75W  
OSRAM included

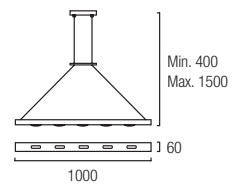

**00-0221-21-F1**

5 x G9 Max. 75W  
OSRAM included





# Adagio





# Troppo

*design* Benedito Design

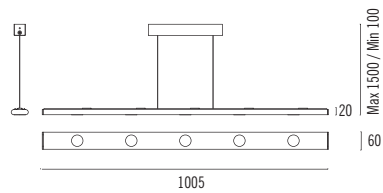

**00-2804-21-F1**

5 x G9 Max. 75W  
OSRAM included

# Tempo

*design Josep Patsí*



Metacrilato transparente matizado  
 Transparent sand-blasted methacrylate  
 Méthacrylate transparent mat  
 Transparentes, mattes Methacrylat  
 Metacrilato trasparente sfumato  
 Metacrilato transparente mate  
 Прозрачный матовый метакрилат  
 Przezroczysty metakrylan cieniowany

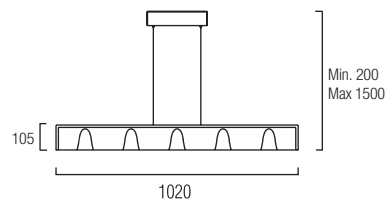

Min. 200  
 Max 1500

**00-2673-AH-AH**  
**00-2673-05-05**

5 x G9 Max. 60W  
 OSRAM included

05 AH

AL PMMA  
 DIF







# Duna

*design* **Álex Sánchez**

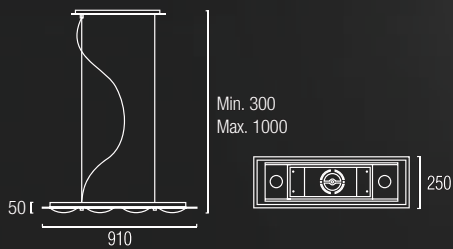

**20-0326-Y6-E9**

4 x G9 Max. 75W  
OSRAM included

Y6

AL GLASS OPT DIF



# Linear

/69

*design* **Benedito Design**

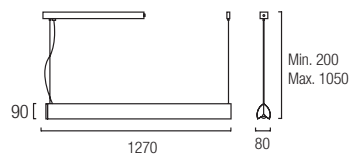

**00-0338-Y6-Y6**

1 x T5 54W  
2700K included

Y6

AL





# Slimm

---

*design* Estudi Ribaudí

---





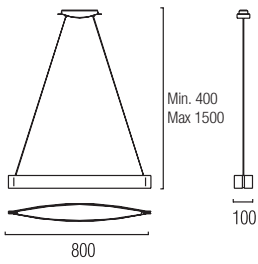

00-2397-Y5-E9  
00-2397-21-E9

2 x R7s L=118 Max. 150W  
OSRAM included

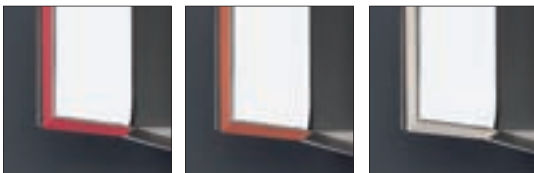

Incluye 3 acrílicos de color intercambiables  
Includes 3 color interchangeable acrylic pieces  
Comprend 3 pièces acryliques de couleur interchangeables  
Mit 3 austauschbaren farbigen Acrylaufsätzen  
Include 3 pezzi in acrilico di colori intercambiabili  
Inclui 3 acrílicos de cores intermutáveis  
3 сменных цветных акриловых вставки  
Zawiera 3 akrylowe elementy o wymiennych kolorach

21 Y5

ST GLASS OPT DIF PMMA DIF



# Spin

*design* Nahrang Design





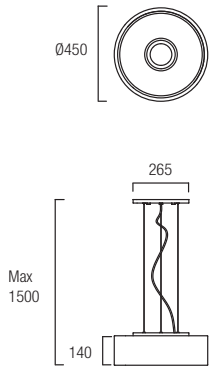

**00-4601-21-05**  
**00-4601-21-14**

3 x E-27 Max. 30W / Max. L=190mm Ø=60mm  
Fluorescent - LED  
**Recommended LED ACT-FLL-050**

**00-4604-21-05\***  
**00-4604-21-14\***

3 x E-27 Max. 30W / Max. L=190mm Ø=60mm  
Fluorescent - LED  
**Recommended LED ACT-FLL-050**  
+ 1 x QR-CBC51 GU5.3 Max. 50W



QR-CBC51 GU5.3\*\* Max. 50W

**00-4605-21-05\***  
**00-4605-21-14\***

3 x E-27 Max. 30W / Max. L=190mm Ø=60mm  
Fluorescent - LED  
**Recommended LED ACT-FLL-050**  
+ LED 3W CREE 2900K included

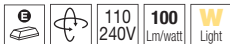

LED 3W CREE

Sistema de doble iluminación independiente  
Independent double lighting system  
Système double éclairage indépendant  
Unabhängiges doppeltes Beleuchtungssystem  
Sistema di doppia illuminazione indipendente  
Sistema de dupla iluminação independente  
Система независимого двойного освещения  
Niezależny system podwójnego oświetlenia

\* Downlight included  
Downlight included

\*\* Halógena no incluída  
Halogen not included

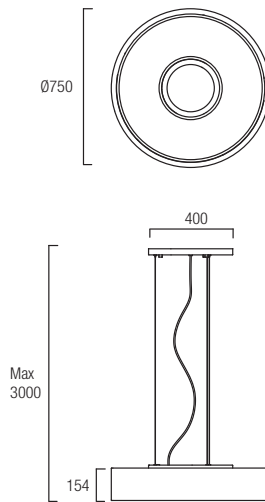

**00-4607-21-05**  
**00-4607-21-14**

5 x E-27 Max. 30W / Max. L=190mm Ø=60mm  
Fluorescent - LED  
**Recommended LED ACT-FLL-050**

**00-4608-21-05\***  
**00-4608-21-14\***

5 x E-27 Max. 30W / Max. L=190mm Ø=60mm  
Fluorescent - LED  
**Recommended LED ACT-FLL-050**  
+ 1 x QR-111 53 Max. 100W



QR-111 53\*\* Max. 100W

**00-4613-21-05\***  
**00-4613-21-14\***

5 x E-27 Max. 30W / Max. L=190mm Ø=60mm  
Fluorescent - LED  
**Recommended LED ACT-FLL-050**  
+ LED 9W CREE 2900K included

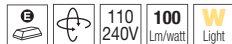

LED 9W CREE

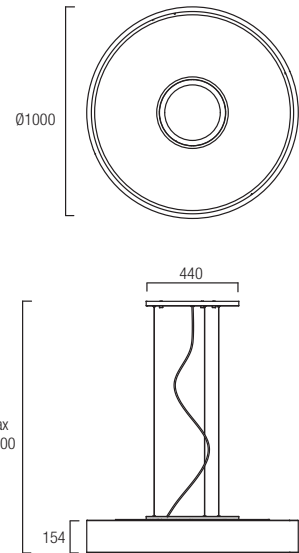

**00-4615-21-05**  
**00-4615-21-14**

7 x E-27 Max. 30W / Max. L=190mm Ø=60mm  
Fluorescent - LED  
**Recommended LED ACT-FLL-050**

**00-4616-21-05\***  
**00-4616-21-14\***

7 x E-27 Max. 30W / Max. L=190mm Ø=60mm  
Fluorescent - LED  
**Recommended LED ACT-FLL-050**  
+ 3 downlights x QR-70 BA15d Max.50W



3 downlights x QR-70 BA15d Max.50W\*\*

**00-4617-21-05\***  
**00-4617-21-14\***

7 x E-27 Max. 30W / Max. L=190mm Ø=60mm  
Fluorescent - LED  
**Recommended LED ACT-FLL-050**  
+ 3 downlights LED 4W CREE 2900K included

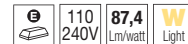

3 downlights LED 4W CREE

**00-4618-21-05\***  
**00-4618-21-14\***

7 x E-27 Max. 30W / Max. L=190mm Ø=60mm  
Fluorescent - LED  
**Recommended LED ACT-FLL-050**  
+ 3 downlights LED 4W CREE 2900K included

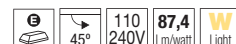

45° 3 downlights LED 4W CREE



# Spin

/75



00-4607-21-14



00-4613-21-05

21 05 14

ST TEX  
TIL PMMA  
DIF



214



# Leila

---

*design* Benedito Design

---

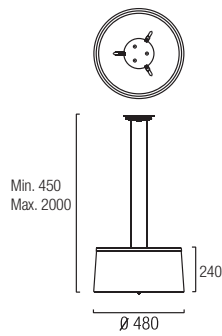
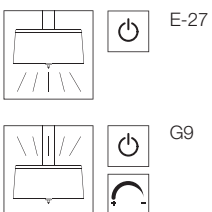

**00-2407-AG-05**  
**00-2407-AG-14**

3 x E-27 Max. 23W / Max. L=180mm Ø=60mm  
 Fluorescent - LED  
**Recommended LED ACT-FLL-050**  
 + 3 x G9 Max. 40W OSRAM included





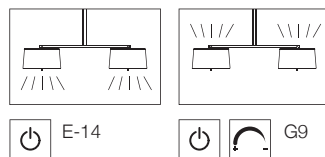
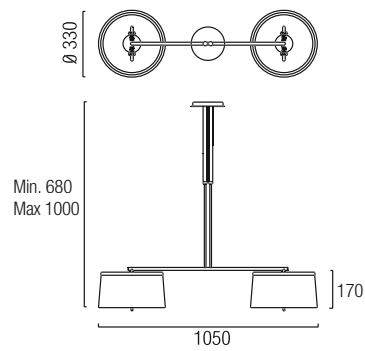

**20-2407-AG-14**

4 x E-14 Max. 15W / Max. L=145mm Ø=60mm  
Fluorescent - LED  
+ 4 x G9 Max. 40W OSRAM included

---

# Wall fixtures

---

	<b>Rizz</b> <i>p.82</i>		<b>Emy</b> <i>p.118</i>
	<b>Ledbox</b> <i>p.86</i>		<b>Flat</b> <i>p.120</i>
	<b>Bend</b> <i>p.92</i>		<b>Mirror</b> <i>p.122</i>
	<b>Line</b> <i>p.96</i>		<b>Skata</b> <i>p.124</i>
	<b>Lov</b> <i>p.98</i>		<b>Slimm</b> <i>p.128</i>
	<b>Supple</b> <i>p.102</i>		<b>Duna</b> <i>p.130</i>
	<b>Open</b> <i>p.104</i>		<b>Boomerang</b> <i>p.132</i>
	<b>Suite</b> <i>p.106</i>		<b>Ciao</b> <i>p.133</i>
	<b>Suite</b> <i>p.108</i>		<b>Traç</b> <i>p.134</i>
	<b>Dress up</b> <i>p.110</i>		<b>Level</b> <i>p.138</i>
	<b>Hotels</b> <i>p.112</i>		<b>Adagio</b> <i>p.139</i>
	<b>Hall</b> <i>p.114</i>		







Rizz new

*design Ramón Valls*

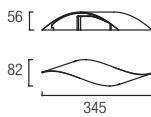
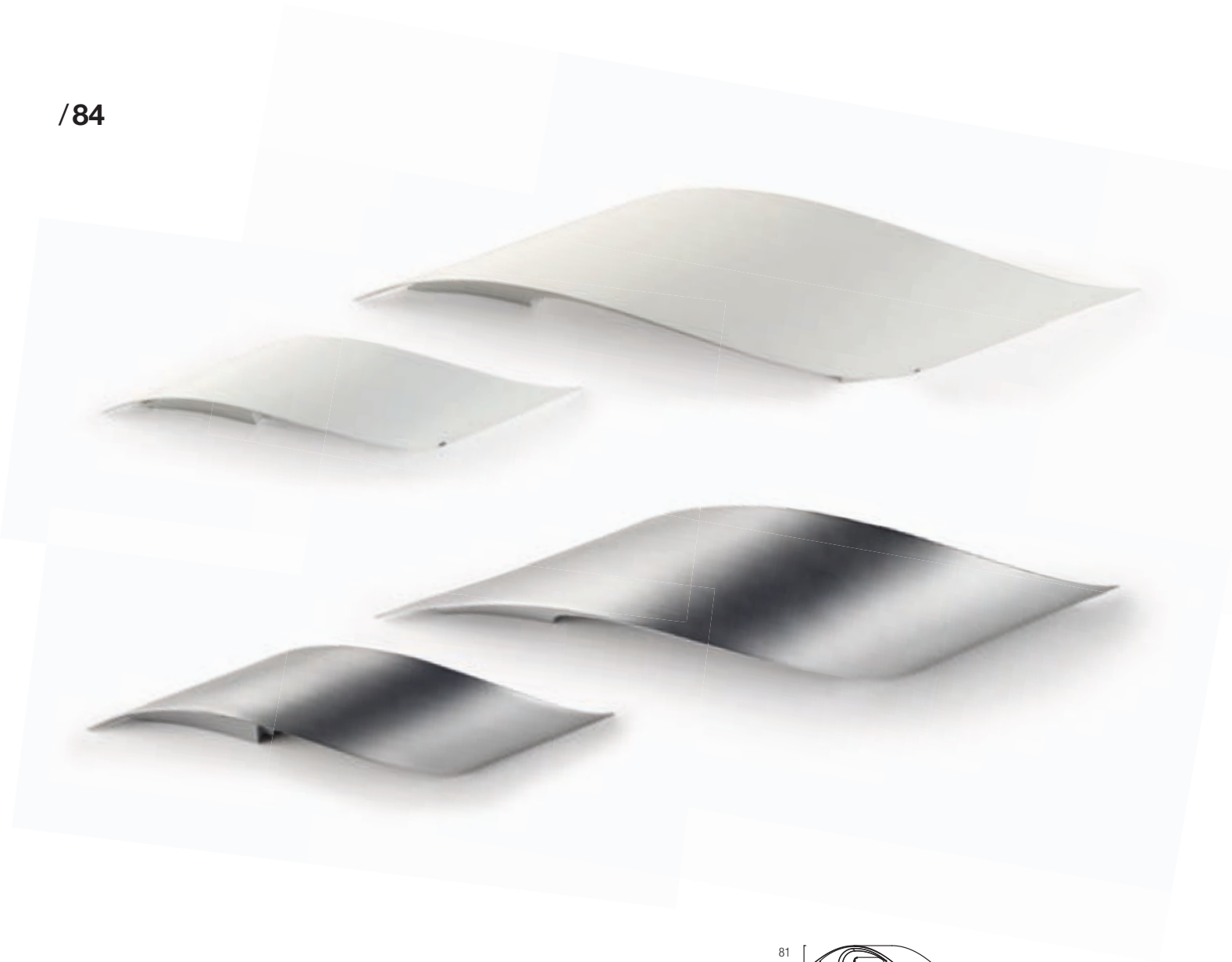

**05-1819-BW-BW**

6 LED x 1W CREE  
3000K included

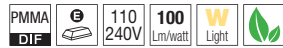

**05-1817-AF-AF**

1 x R7s L=78 Max. 80W  
OSRAM included

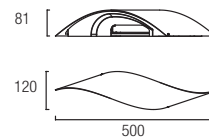

**05-1822-BW-BW**

10 LED x 1W CREE  
3000K included

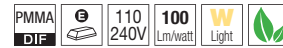

**05-1818-AF-AF**

1 x R7s L=118 Max. 120W  
OSRAM included



Su especial diseño permite múltiples combinaciones.  
Its special design allows for multiple combinations.

Esquema de conexión  
Connection scheme

AF BW

AL





# Ledbox<sup>new</sup>

---

*design Josep Patsí*

---









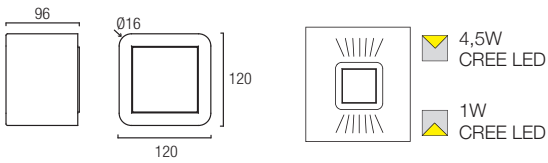

**05-4716-03-M2**

1 LED x 1W CREE 3000K +  
1 LED x 4,5W CREE 3000K  
included



Filtros incluidos / Filters included



Filtros decorativos incluidos / Decorative filters included



Filtros señalización incluidos / Signal filters included



Productos personalizado bajo pedido  
Customized products available upon request  
Produits personnalisés sur commande  
Sonderanfertigungen auf Anfrage  
Prodotti personalizzabili su richiesta  
Produtos personalizados sob encomenda  
Продукция, изготовленная на заказ  
Zindywidualizowane produkty dostępne na zamówienie







Productos personalizado bajo pedido  
 Customized products available upon request  
 Produits personnalisés sur commande  
 Sonderanfertigungen auf Anfrage  
 Prodotti personalizzabili su richiesta  
 Produtos personalizados sob encomenda  
 Продукция, изготовленная на заказ  
 Indywidualizowane produkty dostępne na zamówienie

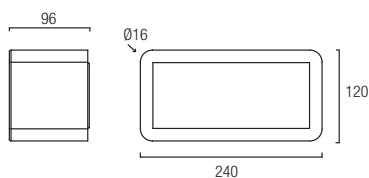

**05-4717-03-M2**

1 x G24q2 18W

03

AL PC PMMA  
DIF



225

# Bend

---

*design* Benedito Design

---





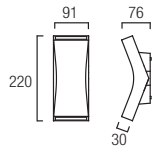

**05-4394-78-M1**  
**05-4394-AH-M1**

2 LED x 4,5W CREE  
 3000K included

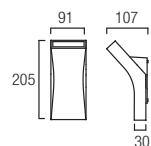

**05-4395-78-M1**  
**05-4395-AH-M1**

1 LED x 4,5W CREE  
 3000K included



78 AH

AL PMMA  
 DIF





# Bend



/96

# Line

---

*design* Nahtrang Design

---

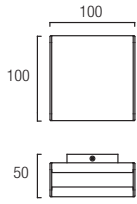

**05-4718-AH-M3**

6 LED x 1W CREE  
3000K included

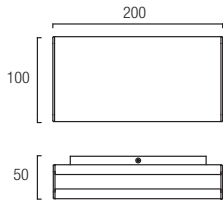
**05-4719-AH-M3**

12 LED x 1W CREE  
3000K included



2 tapas laterales intercambiables y reversibles incluidas.  
It includes 2 interchangeable and reversible side covers.  
2 caches latéraux interchangeables et réversibles inclus.  
inkl. 2 austauschbare und reversible seitliche Abdeckungen.  
Contiene 2 coperchi laterali intercambiabili e reversibili.  
Incluídas 2 tampas laterais inter-cambiáveis e reversíveis.  
Включает две сменные двусторонние боковые панели.  
Zawiera 2 wymienne i dwustronne panele.



Aluminio satinado  
Satin aluminium  
Aluminium satiné  
Aluminium satiniert  
Alluminio satinato  
Aluminio acetinado  
Сатиновый алюминий  
Satynowane Aluminium



Antracita  
Anthracite  
Anthracite  
Anthrakit  
Antracite  
Antracite  
Антрацит  
Antracyt



Aluminio ecobright  
Ecobright aluminium  
Aluminium Ecobright  
Aluminium Ecobright  
Alluminio ecobright  
Aluminio ecobright  
Алюминий Экобрайт  
Jasne Aluminium "E cobright"



Blanco  
White  
Blanc  
Weiß  
Bianco  
Branco  
Белый  
Bialy

AH

AL

PS

DIF

110  
240V80,6  
Lm/watt

Light



# Low

*design Nahtrang Design*

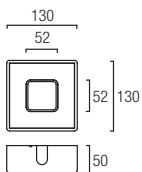
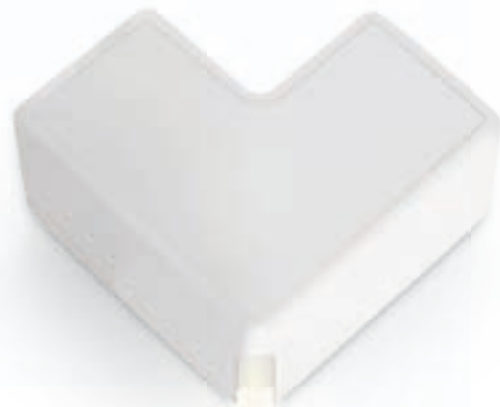

**05-0047-BW-BW** (230V)  
**05-0644-BW-BW** (110-127V)

2 LED x 4W  
3000K included

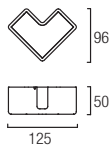

**05-4720-BW-BW** (230V)  
**05-0647-BW-BW** (110-127V)

2 LED x 4W  
3000K included



2 tapas frontales intercambiables incluidas.  
It includes 2 interchangeable front covers.  
2 caches frontaux interchangeables inclus.  
inkl. 2 austauschbare vordere Abdeckungen.  
Contiene 2 coperchi frontali intercambiabili.  
Incluidas 2 tapas frontais inter-cambiáveis.  
Включает 2 сменные лицевые панели.  
Zawiera dwa wymienne fronty.

BW

AL PMMA  
DIF







/100

S  
- POR  
COMPARTIDA





## TOUCH SWITCH

Sistema de doble iluminación independiente.  
 Independent paired lighting system.  
 Système à double éclairage indépendant.  
 Unabhängiges doppeltes Beleuchtungssystem.  
 Sistema a doppia illuminazione indipendente.  
 Sistema de iluminação dupla independente.  
 Система независимого двойного освещения.  
 Niezależny łączony system oświetleniowy.



2 tapas frontales intercambiables incluidas.  
 It includes 2 interchangeable front covers.  
 2 caches frontaux interchangeables inclus.  
 inkl. 2 austauschbare vordere Abdeckungen.  
 Contiene 2 coperchi frontali intercambiabili.  
 Incluídas 2 tampas frontais inter-cambiáveis.  
 Включает 2 сменные лицевые панели.  
 Zawiera dwa wymienne fronty.

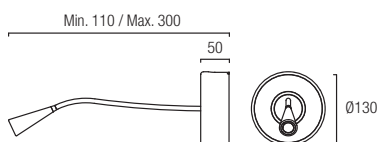

**05-0658-BW-BW** (230V)  
**05-0677-BW-BW** (110-127V)

2 LED x 4W +  
 1 LED x 3W CREE  
 3000K included





# Supple

*design Josep Patsí*



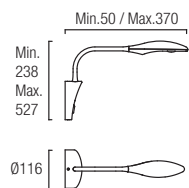

**05-4415-78-M2**

1 LED x 4,5W CREE  
3000K included

78

AL ST SIL PC  
DIF

110 240V
 



 70 Lm/Watt
 

 6

152
 
 263

# Open

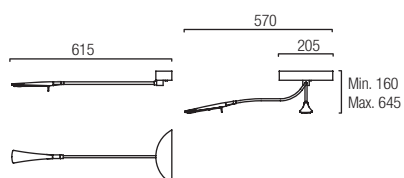
*design Josep Patsí*



**05-2708-21-21**  
**05-2708-AH-AH**

1 LED x 4,5W CREE  
3000K included

21 AH

AL ST PC  
DIF









# Suite

*design* Benedito Design

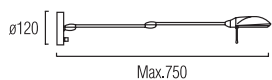

**05-0380-81-B8**  
**05-0380-BW-B8**

1 x G9 Max. 75W  
OSRAM included

<p>81 BW</p>	<p>ST GLASS MAT DIP</p>		
--------------	-------------------------	--	--

# Suite

*design* Benedito Design



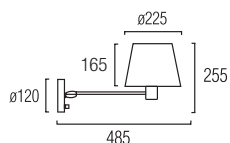

**05-0381-81-AJ**

1 x E-27 Max. 60W / Max. L=140mm Ø=60mm  
Halogen - Fluorescent

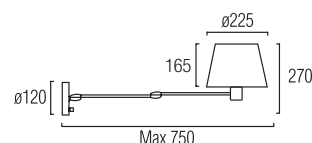

**05-0382-81-AJ**

1 x E-27 Max. 60W / Max. L=140mm Ø=60mm  
Halogen - Fluorescent

# Hotels & Hall collection

# Dress up <sup>new</sup>

Viste la estructura a tu gusto.  
 Dress the structure with the shade of your choice.  
 Habillez la structure à votre goût.  
 Stellen Sie die Struktur nach Ihrem Geschmack ein.  
 Struttura il tuo stile.  
 Veste a estrutura a teu gosto.  
 Выбери абажур и создай свою лампу.  
 Sam dobierz abażur do wybranej lampy.

## 1-Step

Elige la estructura en el acabado que más te guste.  
 Choose the structure in the finish that best suits you.

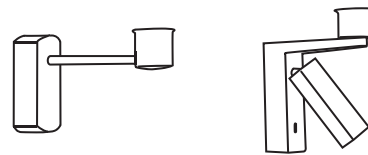

+

## 2-Step

Elige la forma, tamaño y acabado de la pantalla. Verás nuestras recomendaciones en las páginas siguientes.  
 Select the shape, size and finish of the shade. You can see our recommendations on the following pages.

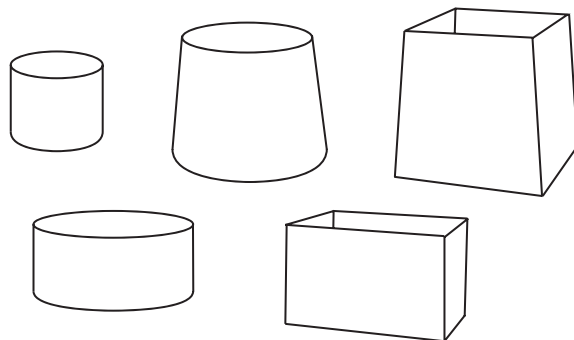

=

## 3-Step

¡Tu lámpara está lista!  
 Your lamp is now ready!

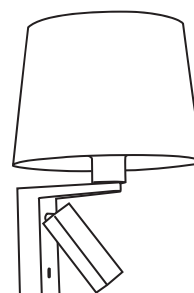



## Pantallas redondas / Round shades

/111

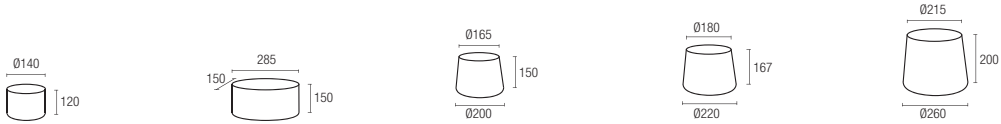

14	PAN-175-14	PAN-177-14	PAN-157-14	PAN-161-14
BY	PAN-175-BY	PAN-177-BY	PAN-157-BY	PAN-161-BY
J6			PAN-158-J6	PAN-162-J6
AJ				PAN-194-AJ

## Pantallas cuadradas / Squared shades

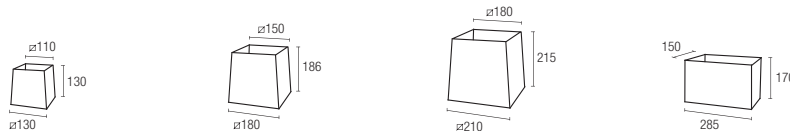

14	PAN 178-14	PAN-179-14	PAN-180-14	PAN-176-14
BY	PAN 178-BY	PAN-179-BY	PAN-180-BY	PAN-176-BY
20	PAN 186-20	PAN 187-20	PAN 188-20	

## Dress up sample book



LEDS-C4 te ofrece la posibilidad de personalizar totalmente las pantallas, eligiendo la forma, el tamaño, el material y el acabado más idóneo para cada ambiente.

LEDS-C4 offers you the possibility to entirely customize the shades, choosing the shape, size, material and the most appropriate design for each atmosphere.



# Hotels

*design* **Benedito Design**



05-2271-U4-82 + PAN-177-14

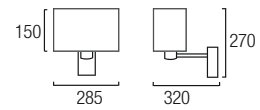

**05-2271-U4-82 + PAN**

1 x E-27 Max. 60W / Max. L=140mm Ø=60mm  
Halogen - Fluorescent - LED  
**Recommended LED ACT-FLL-050**

05-2273-U4-82 + PAN-157-BY

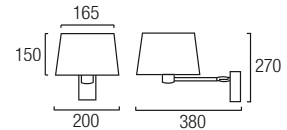

**05-2273-U4-82 + PAN**

1 x E-27 Max. 60W / Max. L=140mm Ø=60mm  
Halogen - Fluorescent - LED  
**Recommended LED ACT-FLL-050**



<b>14</b>	PAN-175-14	PAN-177-14	PAN-157-14		PAN-161-14	PAN 178-14	PAN-179-14	PAN-180-14	PAN-176-14
<b>BY</b>	PAN-175-BY	PAN-177-BY	PAN-157-BY		PAN-161-BY	PAN 178-BY	PAN-179-BY	PAN-180-BY	PAN-176-BY
<b>J6</b>			PAN-158-J6		PAN-162-J6				
<b>20</b>						PAN 186-20	PAN 187-20	PAN 188-20	
<b>AJ</b>				PAN-194-AJ					
05-2271-U4-82	•	•	•	•	•	•	•	•	•
05-2273-U4-82			•	•	•		•		•



05-2271-U4-82 + PAN-179-BY

U4

AL ZAMAK TEXTIL SHADE



# Hall <sup>new</sup>

*design* Nahrang Design



05-1941-BW-82 + PAN-179-14

05-1941-81-82 + PAN-194-AJ

05-1941-BW-82 + PAN-157-14

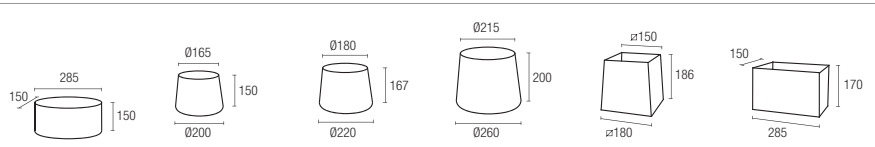
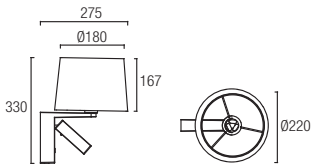

**05-1941-BW-82 + PAN**  
**05-1941-81-82 + PAN**

1 x E-27 Max. 60W /  
Max. L=130mm Ø=60mm  
Halogen - Fluorescent - LED  
**Recommended LED ACT-FLL-050**  
1 x LED 3W CREE 3000K included

14	PAN-177-14	PAN-157-14	PAN-161-14	PAN-179-14	PAN-176-14
BY	PAN-177-BY	PAN-157-BY	PAN-161-BY	PAN-179-BY	PAN-176-BY
J6		PAN-158-J6	PAN-162-J6		
20	PAN 187-20				
AJ	PAN-194-AJ				
<b>05-1941-BW-82</b>	•	•	•	•	•
<b>05-1941-81-82</b>	•	•	•	•	•





05-1941-81-82 + PAN-194-AJ

81	14	AL	ZAMAK	TEXTIL SHADE						CE		100 Lm/watt	W Light							
----	----	----	-------	--------------	--	--	--	--	--	----	--	-------------	---------	--	--	--	--	--	--	--

# Hall

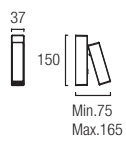

**05-1940-BW-BW**  
**05-1940-81-81**

1 x LED 3W CREE  
 3000K included



# Emy

*design* Francesc Vilaró

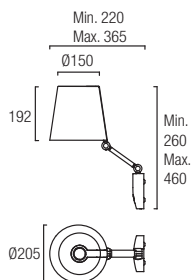

**05-4409-21-12**

1 x E-14 Max. 15W / Max. L=100mm Ø=45mm  
Fluorescent - LED

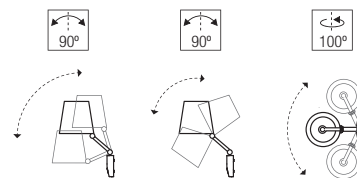

21 12

AL PMMA PMMA  
SHADE DIF









# Flat

*design Josep Patsí*

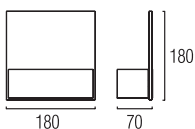

## 05-0570-81-B9

1 x R7s L=78 Max. 100W  
OSRAM included

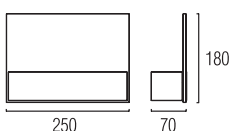

## 05-0571-81-B9

1 x R7s L=118 Max. 150W  
OSRAM included



## 05-2366-81-B9 05-2366-BW-B9



1 x G24d-2 18W

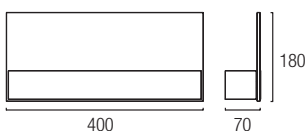

## 05-2367-81-B9 05-2367-BW-B9



2 x G24d-2 18W



Productos personalizado bajo pedido  
Customized products available upon request  
Produits personnalisés sur commande  
Sonderanfertigungen auf Anfrage  
Prodotti personalizzabili su richiesta  
Produtos personalizados sob encomenda  
Продукция, изготовленная на заказ  
Zindywidualizowane produkty dostępne na zamówienie

81 BW

ST ZAMAK GLASS OPT DIF





# Mirror

---

*design Josep Patsí*

---



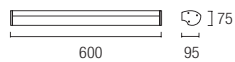

**05-0265-Y6-M1**

1 x T5 24W  
2700K included

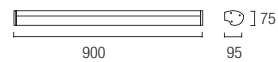

**05-0266-Y6-M1**

1 x T5 39W  
2700K included

Y6

AL PC  
DIF



/124

# Skata

---

*design* Francesc Vilaró

---





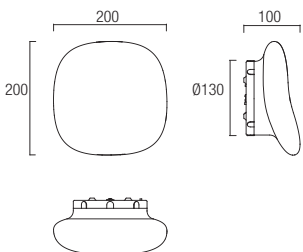

**05-4356-14-F9**

1 x G9 Max. 9W Fluorescent  
1 x G9 Max. 60W Halogen

Su especial diseño permite múltiples combinaciones.  
Its special design allows for multiple combinations.

Esquema de conexión  
Connection scheme









# Slimm

*design Estudi Ribaudí*

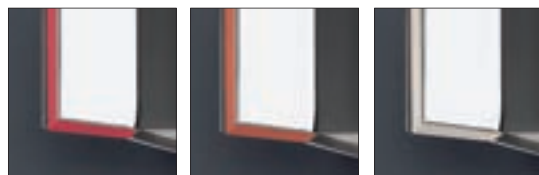
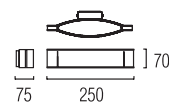

Incluye 3 acrílicos de color intercambiables  
 Includes 3 color interchangeable acrylic pieces  
 Comprend 3 pièces acryliques de couleur interchangeables  
 Mit 3 austauschbaren farbigen Acrylaufsätzen  
 Include 3 pezzi in acrilico di colori intercambiabili  
 Inclui 3 acrílicos de cores intermutáveis  
 3 сменных цветных акриловых вставки  
 Zawiera 3 akrylowe elementy o wymiennych kolorach

**05-2397-Y5-E9**  
**05-2397-21-E9**

1 x R7s L=118 Max. 150W  
 OSRAM included

21 Y5

ST PMMA GLASS  
 DIF OPT DIF



/130

# Duna

*design* Alex Sánchez

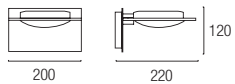

**05-0325-81-E9**

1 x G9 Max. 75W  
OSRAM included





# Boomerang

design Josep Patsí

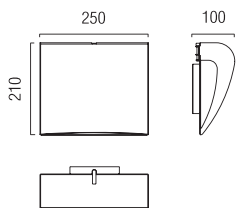

**05-2573-81-B4**

1 x G24d2 18W

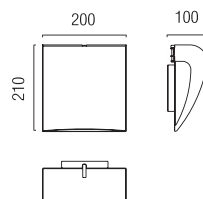

**05-2572-81-B4**

1 x R7s L=118 Max. 150W  
OSRAM included

# Ciao

*design Josep Patsí*

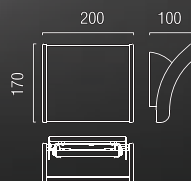

**05-2574-21-B4**

1 x R7s L=118 Max. 150W  
OSRAM included



# Traç

*design Josep Patsí*







# Tıraç

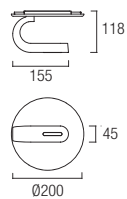

**05-2870-AH-F1**  
**05-2870-D9-F1**  
**05-2870-D8-F1**

1 x G9 Max. 75W  
 OSRAM included



# Level

*design Josep Patsí*

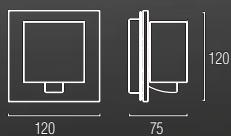
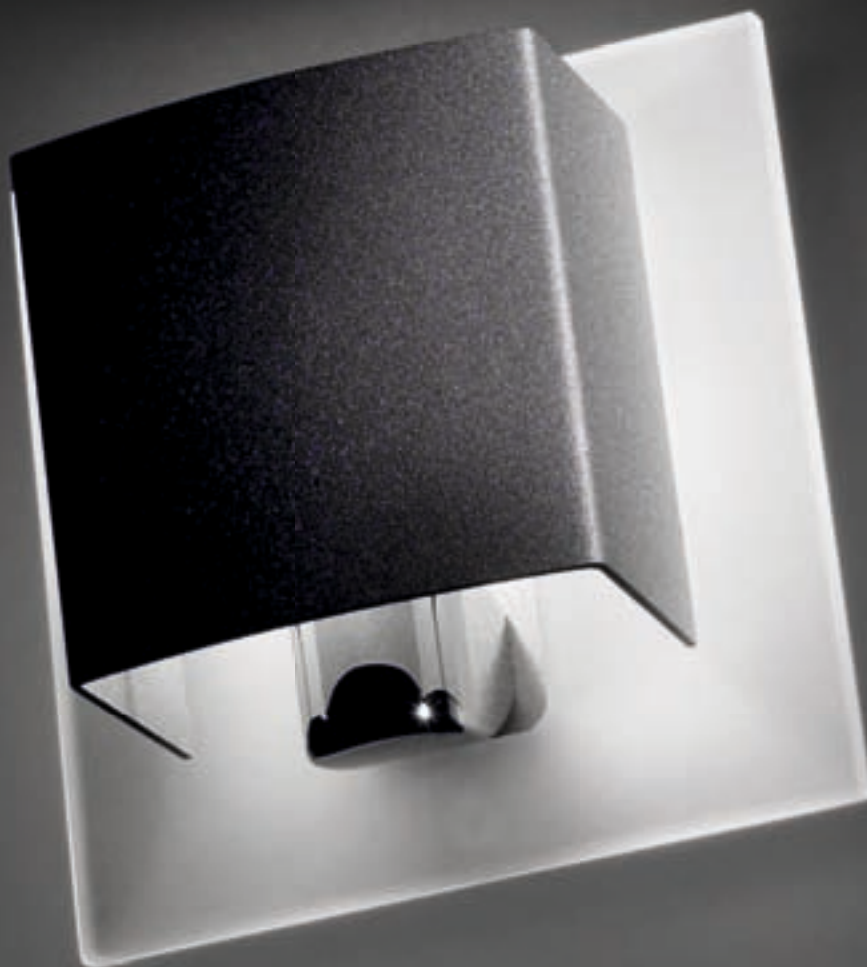

05-0567-N4-B9(S)

1 x G9 Max. 75W  
OSRAM included

N4

ST

ZAMAK

GLASS  
OPT  
DIF



RF  
850



CE





# Adagio

*design Josep Patsí*

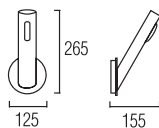

**05-0221-21-F1**

1 x G9 Max. 75W  
OSRAM included

---

# Table lamps

---

	<b>Medusa</b>	<i>p.142</i>
	<b>Blomma</b>	<i>p.146</i>
	<b>Iris</b>	<i>p.148</i>
	<b>Sway</b>	<i>p.150</i>
	<b>Supple</b>	<i>p.152</i>
	<b>Open</b>	<i>p.154</i>
	<b>Office</b>	<i>p.156</i>
	<b>Suite</b>	<i>p.158</i>
	<b>Suite</b>	<i>p.160</i>
	<b>Emy</b>	<i>p.162</i>
	<b>Bonne nuit</b>	<i>p.164</i>

/142

# Medusa <sup>new</sup>

---

*design Ramón Valls*

---











Top diffuser

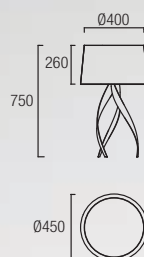

**10-1824-BW-T002**  
**10-1824-BW-T003**

1 x E-27 Max. 18W / Max. L=140mm  
Fluorescent - LED  
Recommended LED ACT-FLL-050

BW T002 T003

AL TEXTIL PVC PMMA  
SHADE SHADE DIF  
T002 T003





# Blomma

---

*design* WIS Design

---





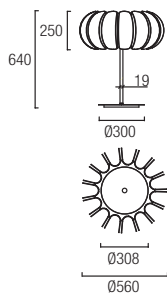

10-4391-BW-03  
 10-4391-BW-05  
 10-4391-BW-25

3 x E-27 Max. 23W / Max. L=140mm Ø=60mm  
 Fluorescent - LED  
 Recommended LED ACT-FLL-050

BW 03 05 25

ST ABS PMMA  
 DIF



# Iris

*design* Gemma Bernal



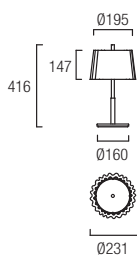

**10-4413-21-M2**

2 x E-14 Max. 15W / Max. L=100mm Ø=45mm  
Halogen - Fluorescent - LED

--	--	--	--





# Sway

*design Josep Patsi*

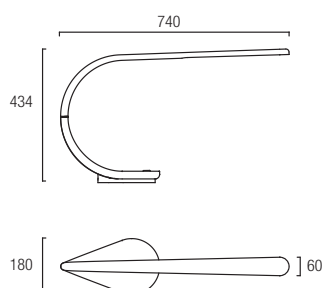

**10-0055-BW-BW**

3 LED x 3W CREE  
3000K included

BW

PUR PMMA  
DIF



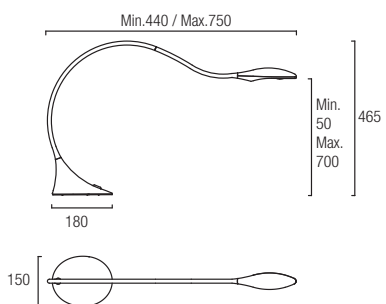

**10-4415-05-M2**  
**10-4415-78-M2**

1 LED x 4,5W CREE  
 3000K included



# Supple

/153

---

*design* Josep Patsí

---





# Open

*design Josep Patsí*





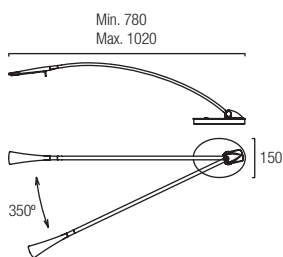

**10-2708-21-21**

1 LED x 4,5W CREE  
3000K included

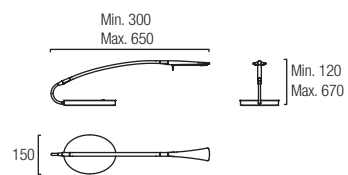

**10-2709-21-21**

1 LED x 4,5W CREE  
3000K included



/156

# Office

---

*design* Grok Team

---





21

AL ST

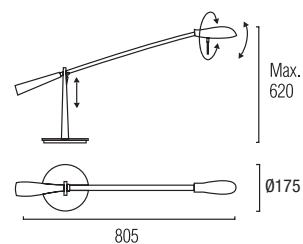

10-0080-21-21

1 x G9 Max. 60W  
OSRAM included

/158





# Suite

*design* Benedito Design

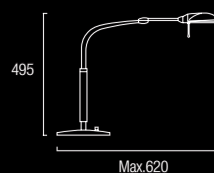

**10-0378-81-B8**  
**10-0378-BW-B8**

1 x G9 Max. 75W  
OSRAM included

BW 81

ST GLASS  
MAT  
DIF



# Suite

*design* **Benedito Design**

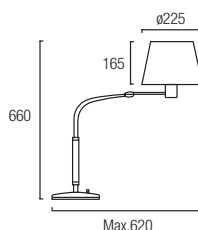

**10-0381-81-AJ<sup>(S)</sup>**

1 x E-27 Max. 60W / Max. L=140mm Ø60mm  
Halogen - Fluorescent

81

ST TEXTIL SHADE





# Emy

*design* Fransesc Vilaró

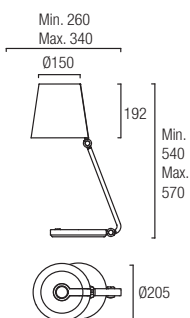

**10-4409-21-12**

1 x E-14 Max. 15W / Max. L=100mm Ø=45mm  
Fluorescent - LED

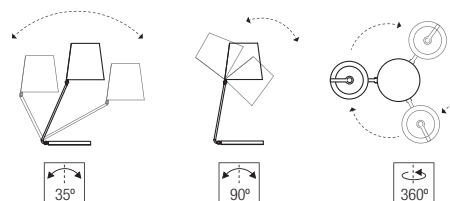

21 12

AL PMMA PMMA  
SHADE SHADE DIF







/164

# Bonne nuit

---

*design* Benedito Design

---

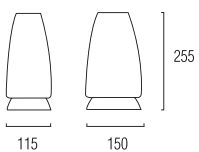

**10-2056-81-F9<sup>(S)</sup>**

1 x E-27 Max. 60W / Max. L=160mm Ø=60mm  
Halogen - Fluorescent - LED

**Recommended LED ACT-FLL-050**

81

ST GLASS  
OPAL 3  
DIF



---

# Ceiling fixtures

---



	<b>Six</b> <i>p.168</i>
	<b>Tandem</b> <i>p.172</i>
	<b>Ace</b> <i>p.176</i>
	<b>Global</b> <i>p.182</i>
	<b>Net</b> <i>p.184</i>
	<b>Traç</b> <i>p.186</i>
	<b>Moon</b> <i>p.188</i>
	<b>Ibis</b> <i>p.190</i>
	<b>Troppo</b> <i>p.192</i>
	<b>Escher</b> <i>p.194</i>
	<b>Adagio</b> <i>p.196</i>
	<b>Ona</b> <i>p.198</i>

	<b>Quattro</b> <i>p.200</i>
	<b>Slight</b> <i>p.202</i>
	<b>Square</b> <i>p.204</i>
	<b>Basic</b> <i>p.206</i>
	<b>Ska</b> <i>p.208</i>
	<b>Ocho</b> <i>p.210</i>
	<b>Spin</b> <i>p.212</i>
	<b>Petra</b> <i>p.216</i>
	<b>Hat</b> <i>p.218</i>
	<b>Nemo</b> <i>p.220</i>
	<b>Mini</b> <i>p.222</i>
	<b>Ledbox</b> <i>p.224</i>

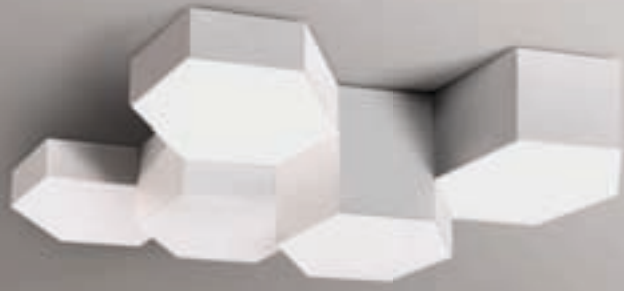

# Six<sup>new</sup>

*design Josep Patsí*

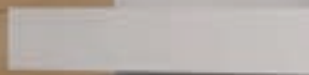



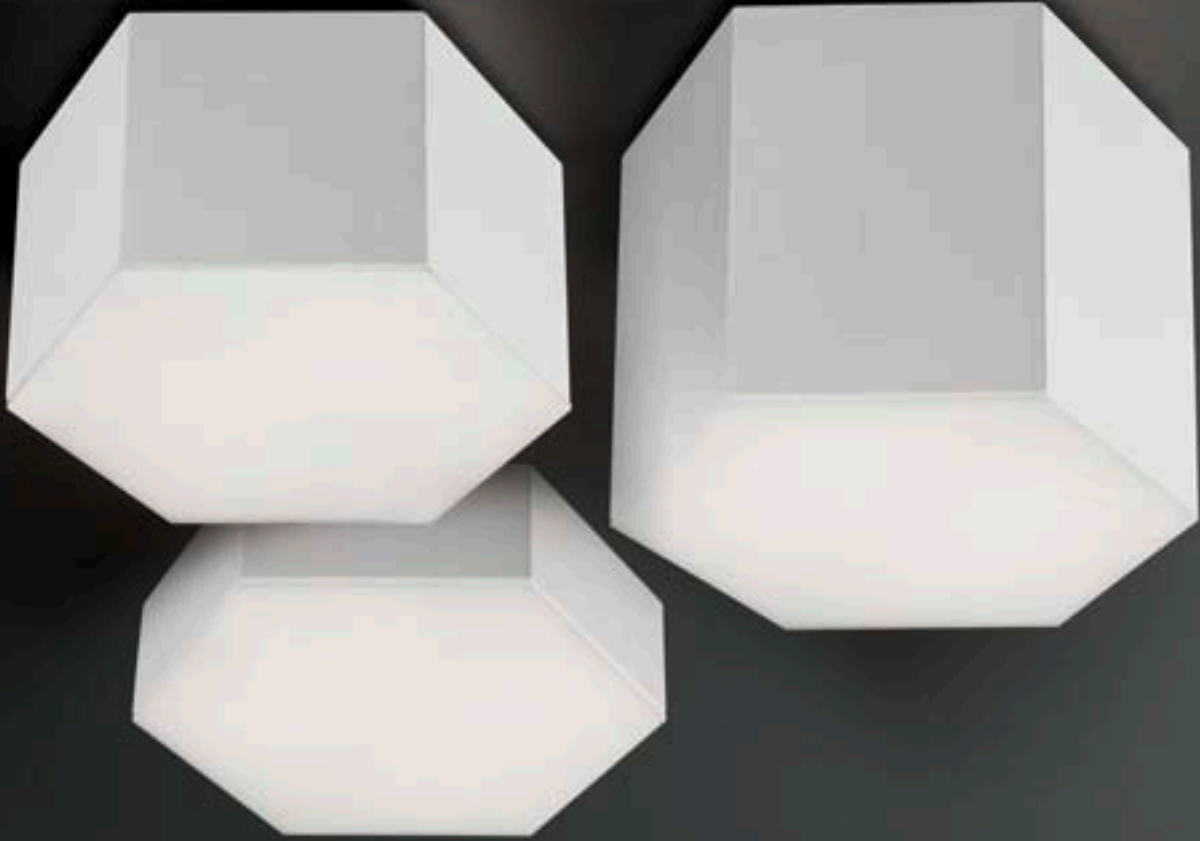

**15-1950-BW-M1**

LED 15W  
3000K included

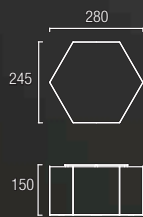

**15-1956-BW-M1**

LED 15W  
3000K included

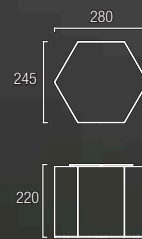

**15-1959-BW-M1**

LED 15W  
3000K included



Para versiones regulables, por favor consulte con equipo comercial  
For dimmable versions, please get in contact with your sales representative.







# Tandem new

*design* Benedito Design









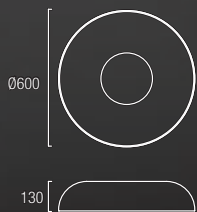

**15-0056-BW-M1**

1 x 2GX13 40W + 1 x 2GX13 22W  
2700K included



**15-0778-BW-M1**

1 x 2GX13 55W  
2700K included

/176

# Ace

---

*design* Josep Patsí

---



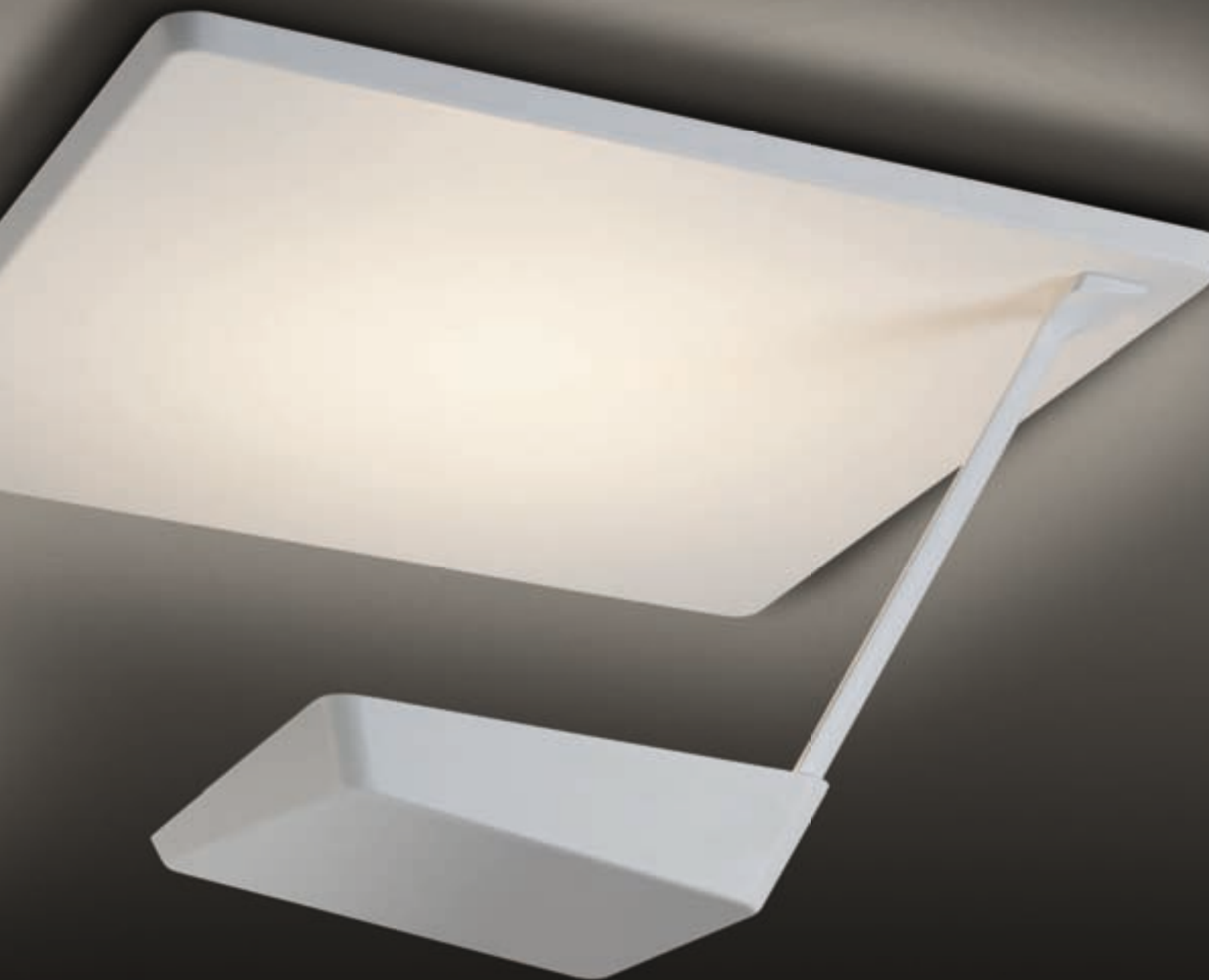

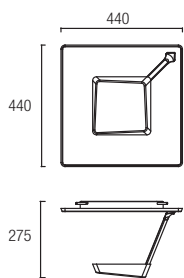

**15-2412-BW-BW**

LED 27W CREE  
3000K included

AL	PMMA DIF	□	Ⓢ	100 240V	100 lm/watt
W Light	🌿	📦	1		

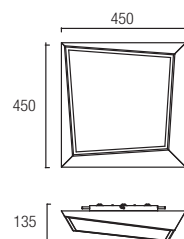

**15-2410-BW-B9**

1 x R7s L=118 Max. 160W  
OSRAM included

GLASS MAT DIF	⊖	⚡	RF 850
📦	1		







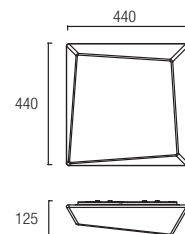

---

**15-2411-BW-M1**

---

1 x 2GX13 40W + 1 x 2GX13 22W  
2700K included







# Global<sup>new</sup>

*design Grok Team*

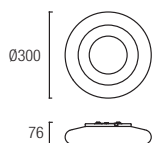

**15-1815-21-F9**

1 x R7s L=78 Max. 120W  
OSRAM included

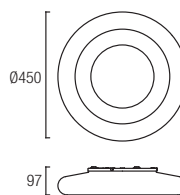

**15-1816-21-F9**

1 x R7s L=118 Max. 160W  
OSRAM included

# Net

*design Josep Patsí*

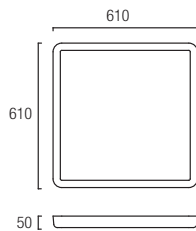

**15-0003-BW-M1** (Standard)  
**15-0835-BW-M1** (Dimmable 1-10V)

LED 40W  
 3000K included



**71-2241-00-00**



Controlador con mando a distancia para 15-0003  
 Controller with remote control for 15-0003



BW

AL PUR PS  
 DIF



23, 24



# Traç

*design Josep Patsí*

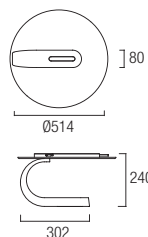

15-2870-AH-F1  
15-2870-D9-F1  
15-2870-D8-F1

1 x R7s L=118 Max. 300W  
OSRAM included









# Moon

*design* **Benedito Design**

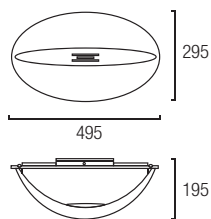

**15-2138-81-81**

1 x R7s L=118 Max. 200W  
OSRAM included

/190

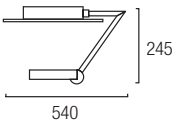

**IBIS C/47-21**  
**IBIS C/47-81**  
**IBIS C/47-BW**

1 x R7s L=118 Max. 300W  
OSRAM included

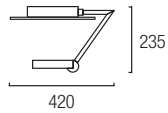

**IBIS C/37-21**  
**IBIS C/37-81**  
**IBIS C/37-BW**

1 x R7s L=118 Max. 200W  
OSRAM included

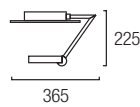

**IBIS C/27-81**

1 x R7s L=78 Max. 150W  
OSRAM included

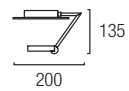

**IBIS C/17-81**

1 x G9 Max. 75W  
OSRAM included



21 81 BW

ST





# Ibis

---

*design* Grok Team

---





# Troppo

*design* **Benedito Design**

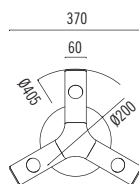
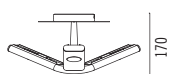

**15-2804-21-F1**

3 x G9 Max. 75W  
OSRAM included

# Escher

*design Josep Patsí*

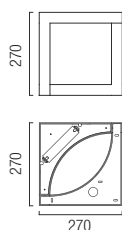
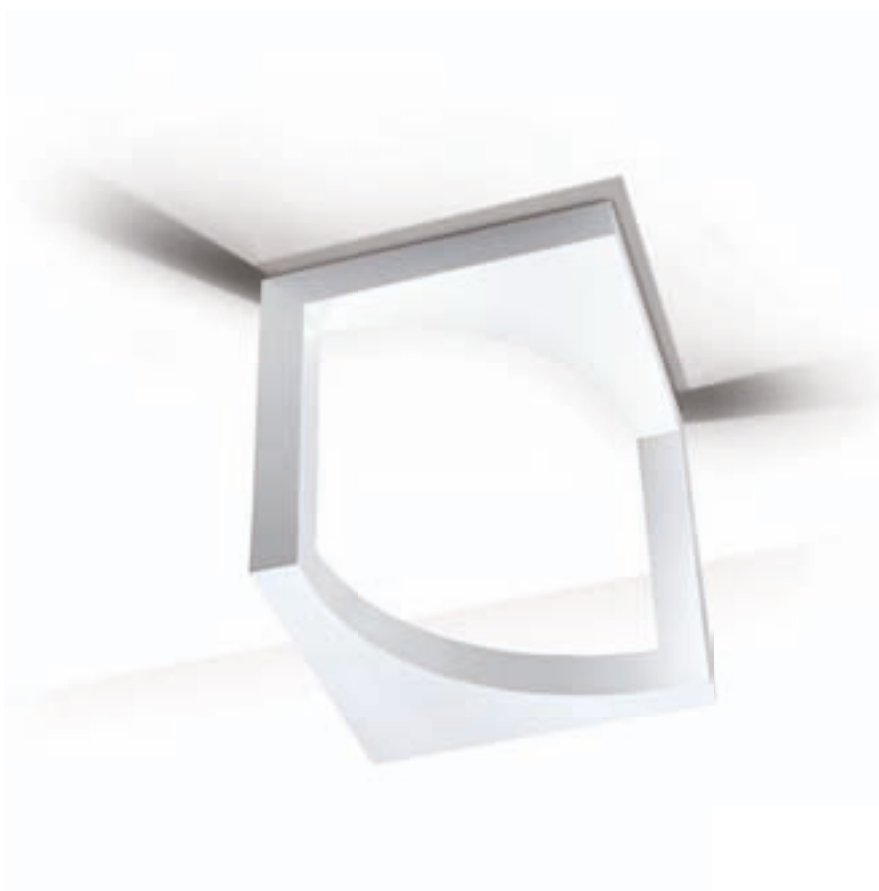

**15-2782-AH-AH**  
**15-2782-78-78**

1 x R7s L=118 Max. 300W  
OSRAM included

AH 78

ST





/ 196

# Adagio

---

*design Josep Patsí*

---







∅ 405

15-0221-21-F1  
15-0221-S3-F1



155

3 x G9 Max. 75W  
OSRAM included

21 S3

AL GLASS MAT DIF



# Ona

*design Josep Patsí*



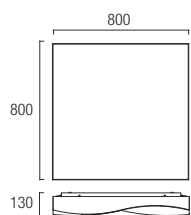

**15-2781-S2-M1**

4 x 2G11 55W  
2700K included

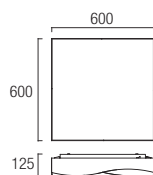

**15-2780-S2-M1**

4 x 2G11 36W  
2700K included

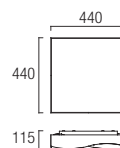

**15-2779-S2-M1**

1 x 2GX13 22W + 1 x 2GX13 40W  
2700K included

S2

AL PMMA  
DIP



/ 200

# Quattro

---

*design* Grok Team

---

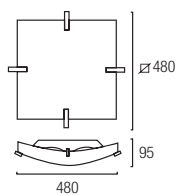

**15-0079-81-B5**

1 x R7s L=118 Max. 300W  
OSRAM included

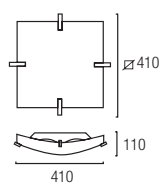
**15-0638-81-B5**

1 x R7s L=118 Max. 150W  
OSRAM included

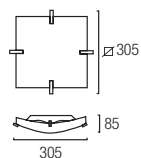
**15-0635-81-B5**

1 x R7s L=118 Max. 150W  
OSRAM included





# Slight

*design Josep Patsí*

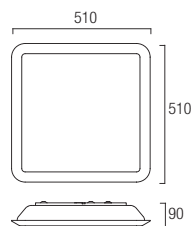

**15-4318-21-F9**

1 x R7s L=118 Max. 230W  
OSRAM included

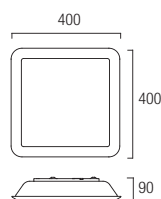

**15-4316-21-F9**

1 x R7s L=118 Max. 160W  
OSRAM included

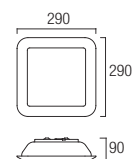

**15-4314-21-F9**

1 x R7s L=78 Max. 120W  
OSRAM included

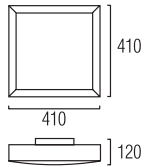
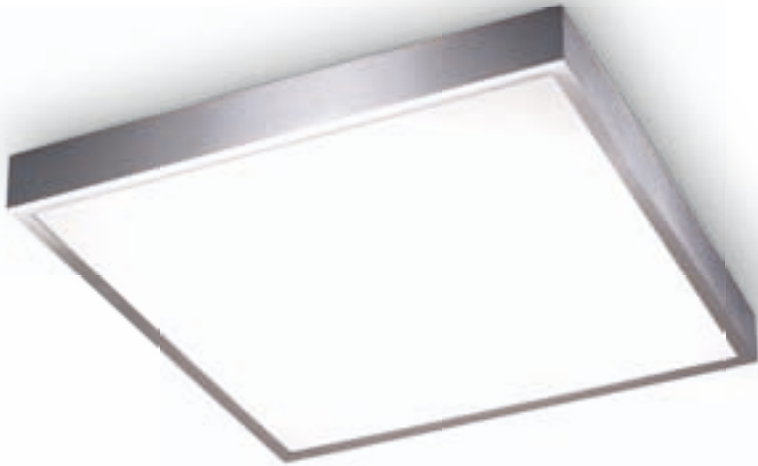

**15-0590-S2-M1**

4 x 2G11 18W  
2700K included

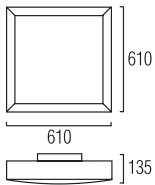

**15-0591-S2-M1**

4 x 2G11 36W  
2700K included

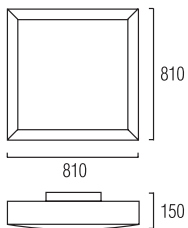

**15-0592-S2-M1**

4 x 2G11 55W  
2700K included

S2

AL PMMA  
DIF

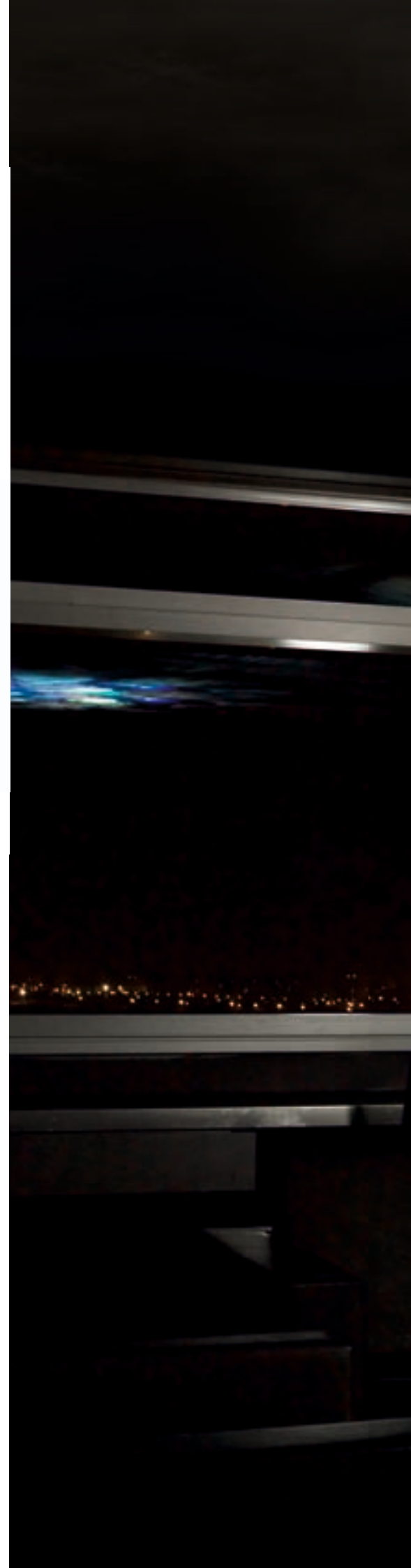

# Square

*design* Toni Dias

# Basic

*design Josep Patsí*

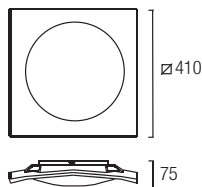

**15-2391-21-E9**

1 x R7s L=118 Max. 200W  
OSRAM included

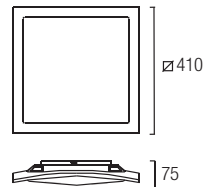

**15-2386-21-B9**

1 x R7s L=118 Max. 200W  
OSRAM included

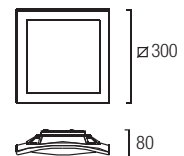

**15-2385-21-B9**

1 x R7s L=78 Max. 150W  
OSRAM included









# Ska

*design Josep Patsí*

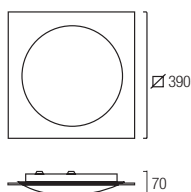
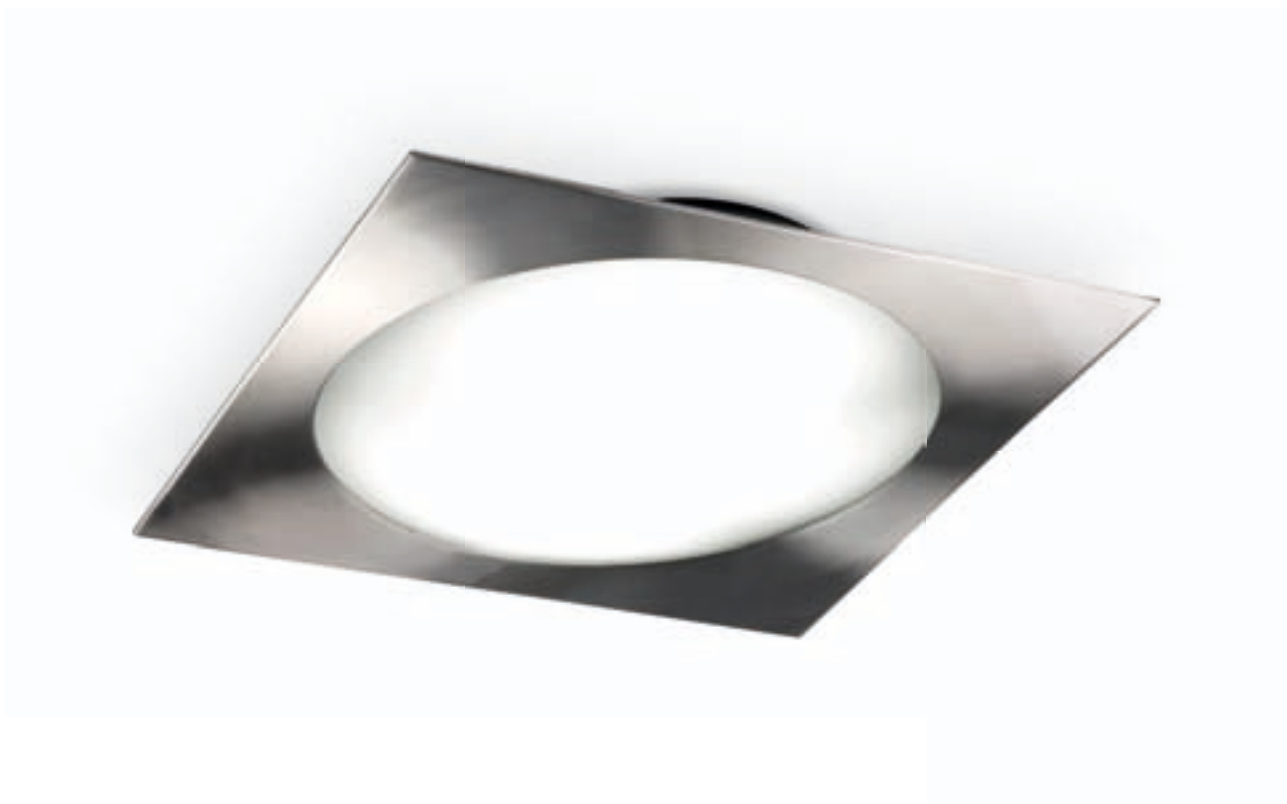

**15-0158-81-E9**

1 x R7s L=118 Max. 200W  
OSRAM included

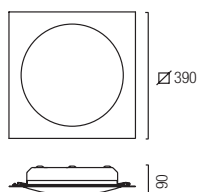

**15-2575-81-E9<sup>(S)</sup>**

3 x G24d-2 18W

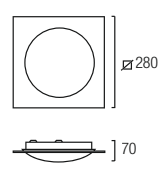

**15-0157-81-E9**

1 x R7s L=118 Max. 150W  
OSRAM included





/210

# Ocho

---

*design Josep Patsí*

---



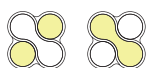

Sistema de doble iluminación independiente  
 Independent double lighting system  
 Système double éclairage indépendant  
 Unabhängiges doppeltes Beleuchtungssystem  
 Sistema di doppia illuminazione indipendente  
 Sistema de dupla iluminação independente  
 Система независимого двойного освещения  
 Niezależny system podwójnego oświetlenia

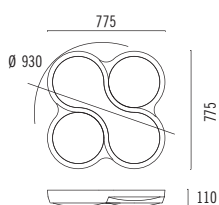
**15-2807-14-M1**

4 x 2GX13 55W  
 2700K included

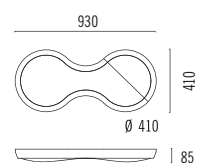
**15-2806-14-M1**

2 x 2GX13 55W  
 2700K included



# Spin

*design* Nahtrang Design





/214



15-4601-21-05  
15-4601-21-14

3 x E-27 Max. 30W / Max. L=190mm Ø=60mm  
Fluorescent - LED  
**Recommended LED ACT-FLL-050**

15-4604-21-05\*  
15-4604-21-14\*

3 x E-27 Max. 30W / Max. L=190mm Ø=60mm  
Fluorescent - LED  
**Recommended LED ACT-FLL-050**  
+ 1 x QR-CBC51 GU5.3 Max. 50W



QR-CBC51 GU5.3\*\* Max. 50W

15-4605-21-05\*  
15-4605-21-14\*

3 x E-27 Max. 30W / Max. L=190mm Ø=60mm  
Fluorescent - LED  
**Recommended LED ACT-FLL-050**  
+ LED 3W CREE 2900K included

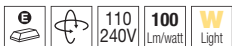

LED 3W CREE

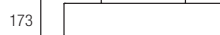
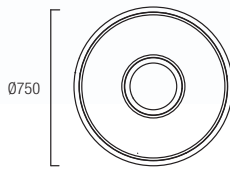

15-4607-21-05  
15-4607-21-14

5 x E-27 Max. 30W / Max. L=190mm Ø=60mm  
Fluorescent - LED  
**Recommended LED ACT-FLL-050**

15-4608-21-05\*  
15-4608-21-14\*

5 x E-27 Max. 30W / Max. L=190mm Ø=60mm  
Fluorescent - LED  
**Recommended LED ACT-FLL-050**  
+ 1 x QR-111 53 Max. 100W



QR-111 53\*\* Max. 100W

15-4613-21-05\*  
15-4613-21-14\*

5 x E-27 Max. 30W / Max. L=190mm Ø=60mm  
Fluorescent - LED  
**Recommended LED ACT-FLL-050**  
+ LED 9W CREE 2900K included

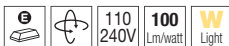

LED 9W CREE

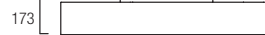
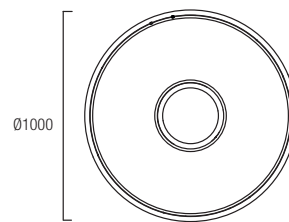

15-4615-21-05  
15-4615-21-14

7 x E-27 Max. 30W / Max. L=190mm Ø=60mm  
Fluorescent - LED  
**Recommended LED ACT-FLL-050**

15-4616-21-05\*  
15-4616-21-14\*

7 x E-27 Max. 30W / Max. L=190mm Ø=60mm  
Fluorescent - LED  
**Recommended LED ACT-FLL-050**  
+ 3 downlights x QR-70 BA15d Max.50W



3 downlights x QR-70 BA15d Max.50W\*\*

15-4617-21-05\*  
15-4617-21-14\*

7 x E-27 Max. 30W / Max. L=190mm Ø=60mm  
Fluorescent - LED  
**Recommended LED ACT-FLL-050**  
+ 3 downlights LED 4W CREE 2900K included

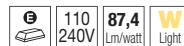

3 downlights LED 4W CREE

15-4618-21-05\*  
15-4618-21-14\*

7 x E-27 Max. 30W / Max. L=190mm Ø=60mm  
Fluorescent - LED  
**Recommended LED ACT-FLL-050**  
+ 3 downlights LED 4W CREE 2900K included

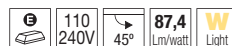

45° 3 downlights LED 4W CREE

Sistema de doble iluminación independiente  
Independent double lighting system  
Système double éclairage indépendant  
Unabhängiges doppeltes Beleuchtungssystem  
Sistema di doppia illuminazione indipendente  
Sistema de dupla iluminação independente  
Система независимого двойного освещения  
Niezależny system podwójnego oświetlenia

\* Downlight incluido  
Downlight included

\*\* Halógena no incluida  
Halogen not included

# Spin

/215



21 05 14

ST TEXTIL PMMA DIF

IP23 R CE



# Petra<sup>new</sup>

*design Gemma Bernal*

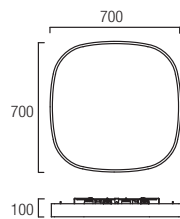

**15-4408-AQ-MI**

4 x 2G11 36W

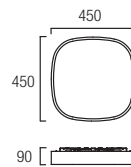

**15-4407-AQ-MI**

1 x 2GX13 22W + 1 x 2GX13 55W

Difusor de metacrilato prismático  
 Methacrylate prismatic diffuser  
 Diffuseur en méthacrylate prismatique  
 Difusor aus Methacrylat mit prismatischer Ablenkung  
 Diffusore in metacrilato prismático  
 Difusor de metacrilato prismático  
 Призматический метакриловый рассеиватель  
 Pryzmatyczny dyfuzor z metakrylanu

 Difusor de alta eficiencia luminica  
 High light efficiency diffuser

AQ

AL PMMA  
 DIF







# Hat

*design Grok Team*

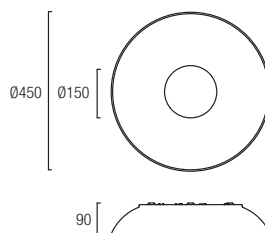

**15-0008-21-M1**

1 x 2GX13 55W  
2700K included





# Nemo

---

*design* Benedito Design

---



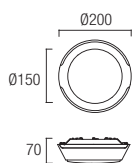

**15-4332-21-F9**

1 x R7s L=78 Max. 100W  
OSRAM included



# Mini

*design Josep Patsí*

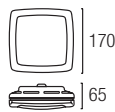
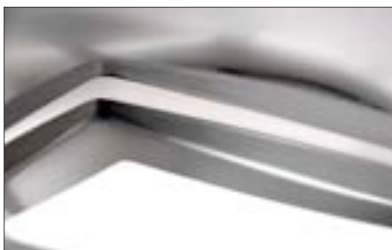

**15-0223-81-E9**

1 x R7s L=78 Max. 100W  
OSRAM included



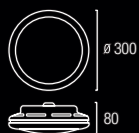
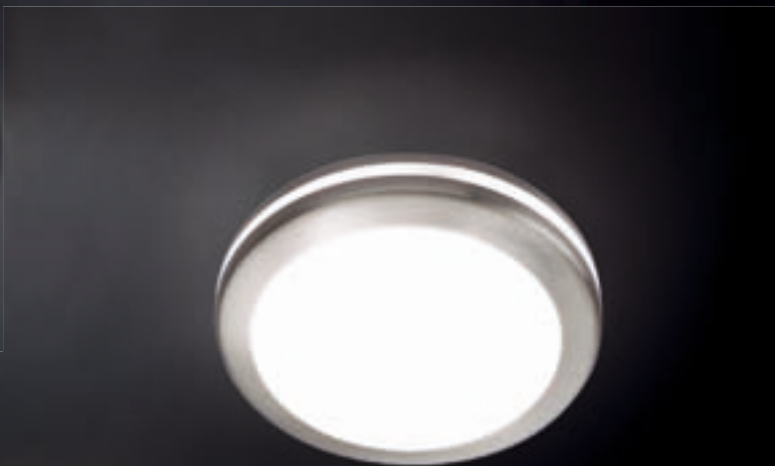

**15-0256-81-E9**

1 x R7s L=118 Max. 200W  
OSRAM included



**15-0222-81-E9**

1 x R7s L=78 Max. 100W  
OSRAM included





# Ledbox

*design Josep Patsí*



03

AL PC

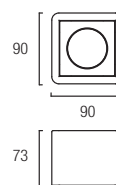

**15-4716-03-M2**

1 x GU10 Max. 35W / L=56mm Ø=50mm  
 Halogen - LED  
**Recommended**  
 LED ACT-FLL-024 5W 24°  
 LED ACT-FLL-025 5W 35°



---

# Floor lamps

---

	<b>Medusa</b>	<i>p.228</i>
	<b>Bosquet</b>	<i>p.232</i>
	<b>Hoop balloons</b>	<i>p.236</i>
	<b>Hoop</b>	<i>p.240</i>
	<b>Everyday outdoor</b>	<i>p.244</i>
	<b>Blomma</b>	<i>p.248</i>
	<b>Iris</b>	<i>p.250</i>
	<b>Emy</b>	<i>p.252</i>
	<b>Leila</b>	<i>p.256</i>
	<b>Suite</b>	<i>p.258</i>
	<b>Suite</b>	<i>p.259</i>
	<b>Open</b>	<i>p.260</i>
	<b>Supple</b>	<i>p.262</i>
	<b>Kubik</b>	<i>p.264</i>
	<b>Arc</b>	<i>p.266</i>
	<b>Adagio</b>	<i>p.268</i>
	<b>Totem</b>	<i>p.270</i>

# Medusa<sup>new</sup>

---

*design* Ramón Valls

---





/230





# Medusa

/231

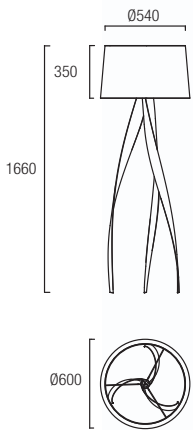

**25-1823-BW-T002**  
**25-1823-BW-T003**

1 x E-27 Max. 30W /  
 Max. L=195mm Ø=60mm  
 Fluorescent - LED  
**Recommended**  
**LED ACT-FLL-050**

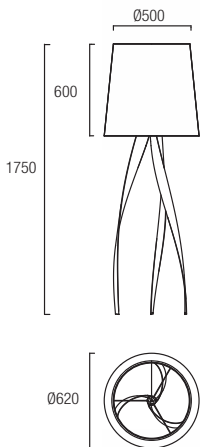

**25-1824-BW-T002**  
**25-1824-BW-T003**

1 x E-27 Max. 30W /  
 Max. L=195mm Ø=60mm  
 Fluorescent - LED  
**Recommended**  
**LED ACT-FLL-050**



**71-1759-BW-BW**



# Bosquet new

---

*design* Ramón Valls

---







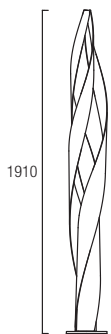

## 25-1837-05-05

1 x E-27 Max.150W /  
Max. L=195mm Ø= 60mm  
Halogen - Fluorescent - LED  
Recomended E-27 PAR 30 Max.75W

05

AL





# Hoop balloons

---

*design Josep Patsí*

---





# Hoop balloons



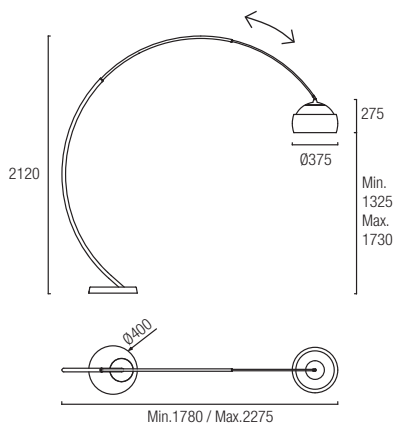
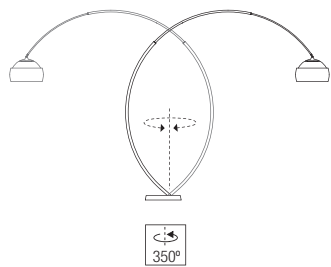

**25-0058-BW-M1**

1 x E-27 Max. 23W / Max. L=160mm Ø=60mm  
 Fluorescent - LED  
**Recommended LED ACT-FLL-050**

			<p>39</p>
--	--	--	-----------



/240

# Hoop

*design Josep Patsí*







/242

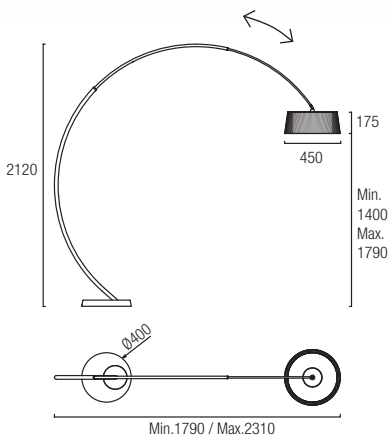

**25-0057-BW-M1**

3 x E-27 Max. 23W / Max. L=140mm Ø=60mm  
Fluorescent - LED  
Recommended LED ACT-FLL-050

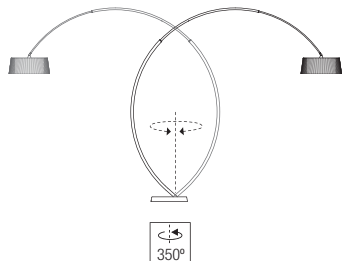

BW

ST PMMA PUR  
DIF SHADE



# Hoop

/243







# Everyday outdoor

---

*design JBA design*

---







/246

## Everyday outdoor

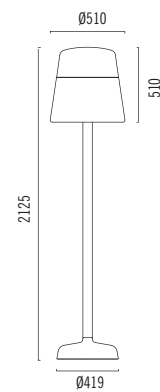

**25-2803-14-M1**

1 x E-27 Max. 150 W / Max. L=195mm Ø=60mm  
Halogen - Fluorescent - LED

**Recommended LED ACT-FLL-050**

ELEMENTOS DE FIJACIÓN AL SUELO INCLUIDOS  
FLOOR INSTALLATION ACCESSORIES INCLUDED

14

AL PE  
DIF





/248

# Blomma

*design* WIS Design



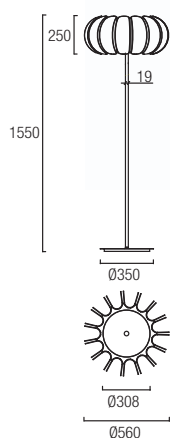

25-4391-BW-03  
 25-4391-BW-05  
 25-4391-BW-25

3 x E-27 Max. 23W / Max. L=140mm Ø=60mm  
 Fluorescent - LED  
 Recommended LED ACT-FLL-050

BW 03 05 25

ST ABS PMMA  
 DIF



43

147



/250

# Iris

---

*design* Gemma Bernal

---

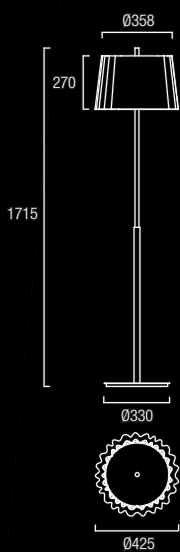

25-4413-21-M2

1 x 2GX13 55W



21				
ST	PMMA DIF	PMMA SHADE		
45	149			

/ 252



# Emy

*design* Fransesc Vilaró









# Emy

/255

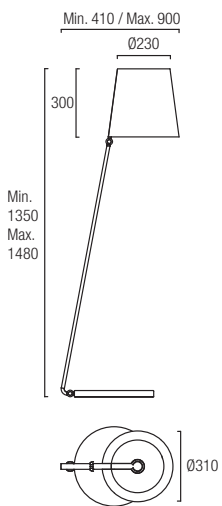

25-4409-21-12

1 x E-27 Max. 30W / Max. L=180mm Ø=60mm  
 Fluorescent - LED  
 Recommended LED ACT-FLL-050

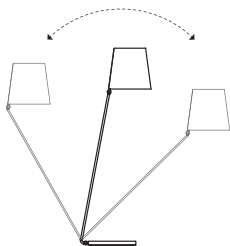

35°



90°

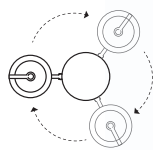

360°



21 12

AL PMMA PMMA  
 SHADE DIF



# Leila

*design* Benedito Design

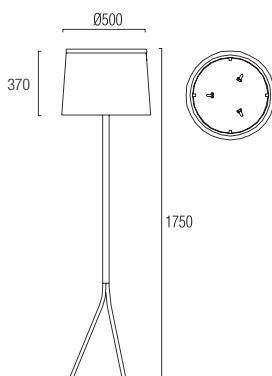

25-2407-AG-05  
25-2407-AG-14

3 x E-27 Max. 23W / Max. L=140mm Ø=60mm  
Fluorescent - LED  
**Recommended LED ACT-FLL-050**  
+ 3 x G9 Max. 40W OSRAM included

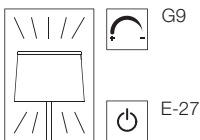

AG 05 14

AL ST TEXTIL SHADE

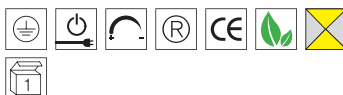

77, 79







/258

# Suite

*design* Benedito Design

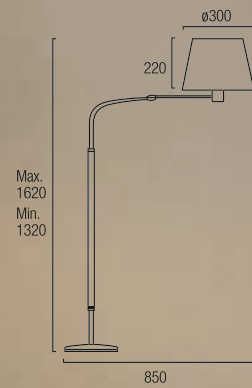

**25-0381-81-AJ**

1 x E-27 Max. 100W / Max. L=140mm Ø=60mm  
Halogen - Fluorescent

81

ST TEXTIL SHADE



109 160

# Suite

*design* Benedito Design

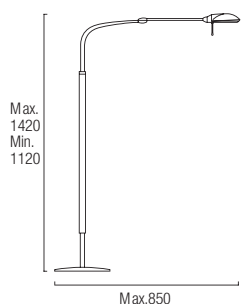

**25-0378-81-B8<sup>(S)</sup>**

1 x G9 Max. 75W /  
OSRAM included



/260

# Open

*design Josep Patsí*

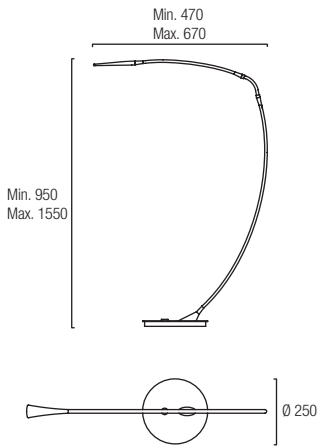

25-2708-21-21<sup>(S)</sup>

1 LED x 4,5W CREE  
3000K included



21

AL ST PC  
DIF









/ 262

# Supple

*design Josep Patsí*



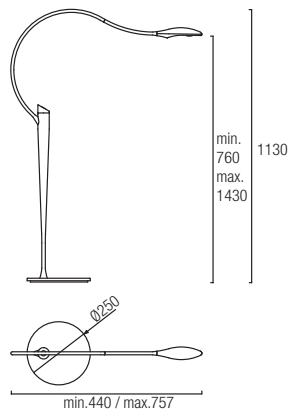
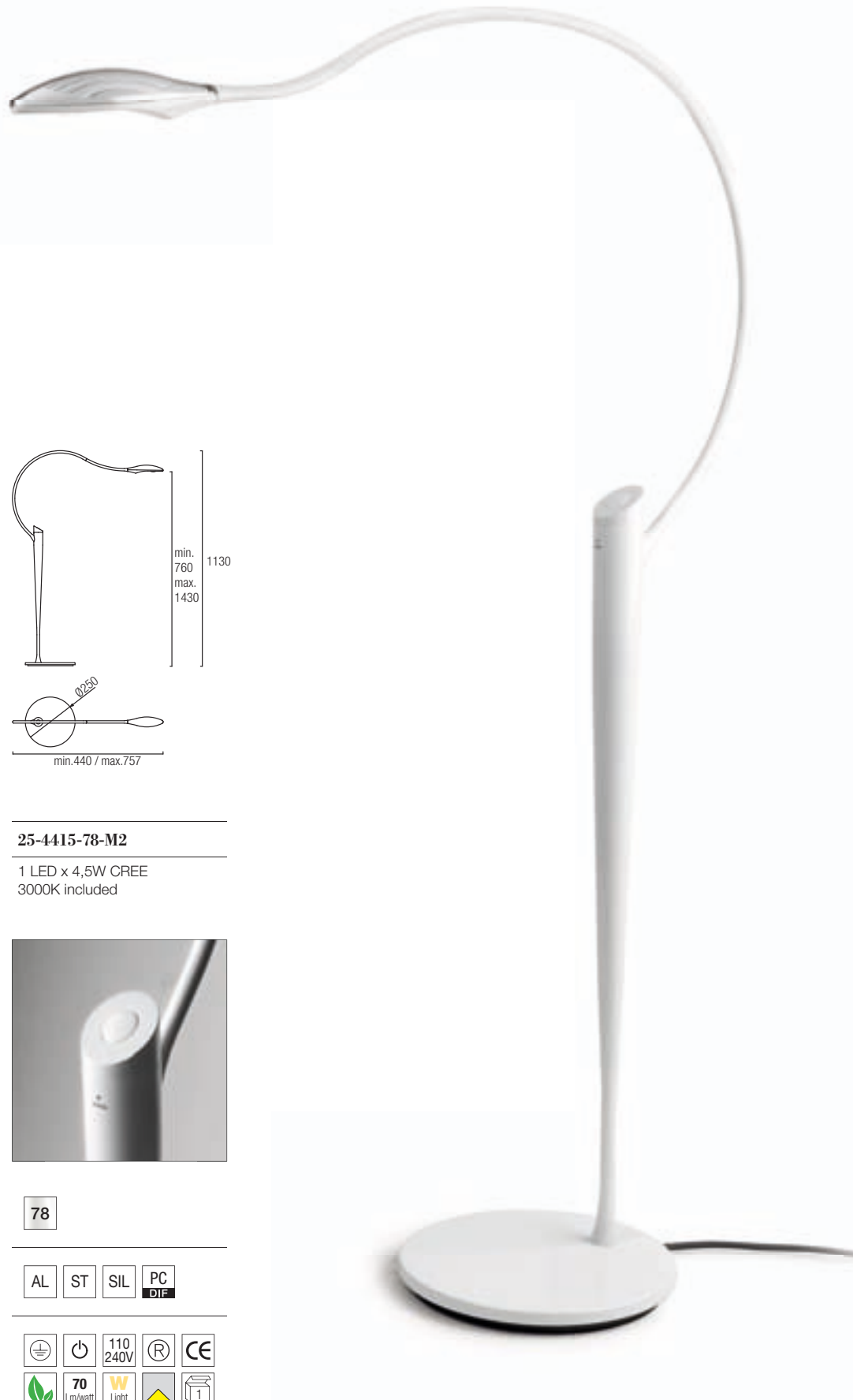

**25-4415-78-M2**

1 LED x 4,5W CREE  
3000K included



78

AL ST SIL **PC**  
DIF

103 152

# Kubik

*design Josep Patsí*

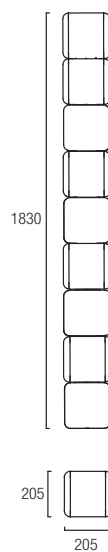

25-4423-03-M3

2 x T5 39W

03

ABS PMMA  
DIF







# Arc

*design Estudi Ribaudí*



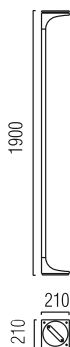

25-2580-AH-AH  
25-2580-05-05  
25-2580-78-78

1 x R7s L=118 Max. 300W  
OSRAM included

05 78 AH

AL PMMA  
DIF





# Adagio

/269

*design Josep Patsí*

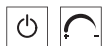

**25-0221-21-F1**

3 x G9 Max. 75W  
OSRAM included

21

AL GLASS  
MAT  
DIF

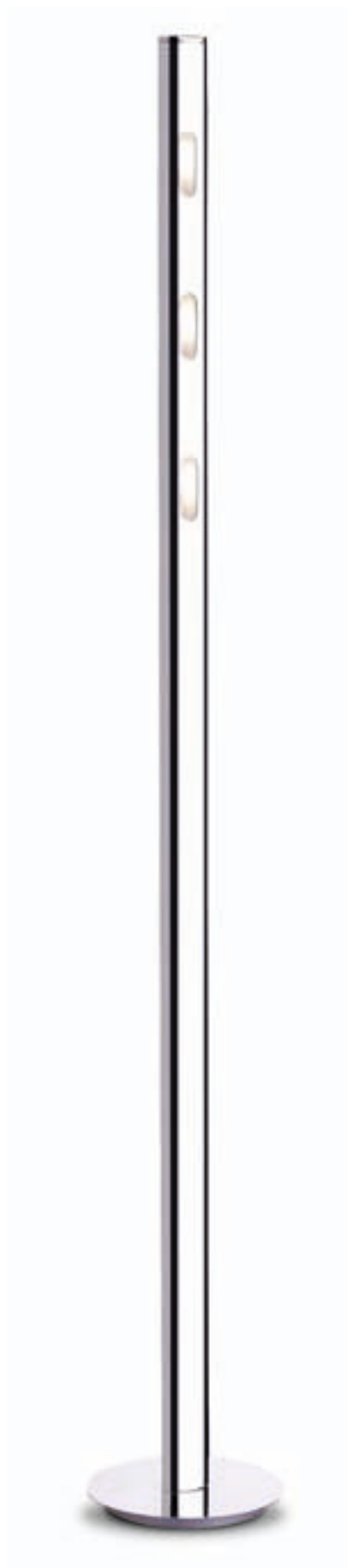



/270

# Totem

---

*design Josep Patsí*

---





Luz superior halógena  
Halogen top light

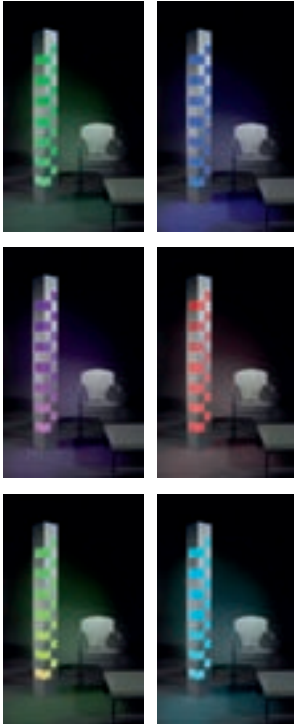

RGB color system with LEDS



HALOGEN LIGHT  
ON THE TOP



VERTICAL  
FLUORESCENT  
LIGHT



LED COLOR  
CONTROL  
6-position push  
button

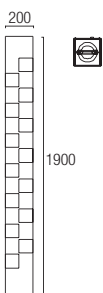

**25-2384-AF-MI**

1 x R7s L=118 Max. 300W  
OSRAM included  
+ 1 x T8 58W  
included  
+ 95 LEDS RGB COLOR SYSTEM  
included





---



























# General information

---









LÁMPARAS / LAMPS / LAMPES / LAMPEN / LAMPADINE / LÂMPADAS / ЛАМПЫ / LAMPA

/274

	CÓDIGO CODE	CASQUILLO SOCKET	W	K	V	LM	HAZ ANGLE (°)	I (Cd)	VIDA LIFE (h)	DIÁMETRO DIAMETER (mm)	LONGITUD LENGTH (mm)	EMBALAJE (mm) (alto x ancho x profundo) PACKAGING (mm) (height x width x depth)	
<b>FLUORESCENTE COMPACTA NO INTEGRADA (CFL-ni) / COMPACT FLUORESCENT NO INTEGRATED (CFL-ni)</b>													
	ACT-FLF-021	2G11	18	3.000		1.200			8.000	17,5	217	260 x 103 x 136	10
	ACT-FLF-022	2G11	24	3.000		1.800			8.000	17,5	317	365 x 107 x 140	10
	ACT-FLF-024	G5	39	4.000		3.100			16.000	16	849	90 x 110 x 887	20
	ACT-FLF-025	G5	54	4.000		4.450			16.000	16	1.149,00	83 x 104 x 1182	20
	ACT-FLF-027	G5	39	3.000		3.100			16.000	16	849	90 x 110 x 887	20
	ACT-FLF-028	G5	54	3.000		4.450			16.000	16	1.149,00	83 x 104 x 1182	20
	ACT-FLF-039	G5	24	3.000		1.750			16.000	16	549	95 x 198 x 598	40
	ACT-FLF-003	G24d-2	18	830	230	1.200			8.000	34 x 34	153	174 x 81 x 186	10
	ACT-FLF-004	G24d-2	18	840	230	1.200			8.000	34 x 34	153	174 x 81 x 186	10
<b>FLUORESCENTE COMPACTA INTEGRADA (CFL-i) / COMPACT FLUORESCENT INTEGRATED (CFL-i)</b>													
	ACT-FLF-058	E14	10	2.500	220-240	445			10.000	39	124	137 x 88 x 211	10
	ACT-FLF-041	E14	11	2.500	220-240	660			20.000	45	126	145 x 102 x 242	10
	ACT-FLF-042	E27	11	2.500	220-240	660			20.000	45	117	145 x 102 x 242	10
	ACT-FLF-043	E27	14	2.500	220-240	820			20.000	45	131	145 x 102 x 242	10
	ACT-FLF-044	E27	22	2.500	220-240	1.440			20.000	58	176	194 x 127 x 310	10
	ACT-FLF-045	E27	18	2.500	220-240	1.060			10.000	120	170	179 x 259 x 630	10
	ACT-FLF-047	E27	18	4.000	220-240	1.200			12.000	55	111	142 x 120 x 289	10
	ACT-FLF-048	E27	18	2.500	220-240	1.200			12.000	55	111	142 x 120 x 289	10
	ACT-FLF-050	E27	23	4.000	220-240	1.600			12.000	58	119	150 x 120 x 289	10
	ACT-FLF-051	E27	23	2.500	220-240	1.600			12.000	58	119	150 x 120 x 289	10
	ACT-FLF-052	E27	30	4.000	220-240	1.940			15.000	58	195	215 x 127 x 310	10
	ACT-FLF-053	E27	30	2.500	220-240	1.940			15.000	58	195	215 x 127 x 310	10
	ACT-FLF-055	E27	7	4.000	220-240	420			12.000	42	88	116 x 90 x 214	10
	ACT-FLF-056	E27	7	2.500	220-240	420			12.000	42	88	116 x 90 x 214	10
<b>HALÓGENA / HALOGEN</b>													
	ACT-FLH-027	GU10	40	2.800	230		30	900	2.000	50,7	55	131 x 110 x 257	20
	ACT-FLH-030	G9	33	2.700	230	460			2.000	14	43	118 x 55 x 144	20
	ACT-FLH-031	G9	48	2.800	230	740			2.000	14	51	118 x 55 x 144	20
	ACT-FLH-032	R7s (118mm)	230	2.950	230	5.000			2.000	12	114,2	77 x 112 x 137	20
	ACT-FLH-033	R7s (78mm)	120	2.950	230	2.300			2.000	12	74,9	77 x 112 x 92	20
<b>INCANDESCENTE / INCANDESCENT / INCANDESCENTES</b>													
	ACT-FLL-001	E27 PAR-38	60	2.500	230		30	1200	2.000	122	136	151 x 344 x 46	12
<b>LED RETROFIT</b>													
	ACT-FLL-001 <sup>(s)</sup>	E27	8	6.500	100-240	450 / 345			25.000	55	113	135 x 126 x 299	10
	ACT-FLL-002 <sup>(s)</sup>	E27	8	3.000	100-240	450 / 345			25.000	55	113	135 x 126 x 299	10
	ACT-FLL-009 <sup>(s)</sup>	GU10	4	2.700	220-240		40	450	40.000	50	52,5	77 x 114 x 271	10
	ACT-FLL-010 <sup>(s)</sup>	GU10	7	2.700	220-240		40	310	25.000	50,2	80,5	77 x 114 x 271	10

CÓDIGO CODE CASQUILLO SOCKET W K V LM HAZ ANGLE (°)  I (Cd) VIDA LIFE (h) DIÁMETRO DIAMETER (mm) LONGITUD LENGTH (mm) EMBALAJE (mm) (alto x ancho x profundo) PACKAGING (mm) (height x width x depth) 

**LED (LEDS-C4)**



	<b>ACT-FLL-015</b>	GU10	10	3.000	220-240	580	24°	•	4.200	>30.000	111	93	275 x 275 x 125	<b>4</b>
	<b>ACT-FLL-017</b>	GU10	10	3.000	220-240	580	35°	•	2.000	>30.000	111	93	275 x 275 x 125	<b>4</b>
	<b>ACT-FLL-032</b>	GU10	15	3.000	220-240	824	24°	•	6.000	>30.000	111	104	275 x 275 x 136	<b>4</b>
	<b>ACT-FLL-033</b>	GU10	15	3.000	220-240	872	35°	•	3.000	>30.000	111	104	275 x 275 x 136	<b>4</b>
	<b>ACT-FLL-024</b>	GU10	5	3.000	220-240	165	24°		1.200	>30.000	50	57	389 x 356 x 178	<b>10</b>
	<b>ACT-FLL-025</b>	GU10	5	3.000	220-240	160	35°		550	>30.000	50	57	389 x 356 x 178	<b>10</b>



Ahorro energético del 88%  
Alto confort visual  
Emisión de luz uniforme  
Amplio ángulo de emisión: 260°

Energy savings of 88%  
High visual comfort  
Light emission uniformity  
Wide beam angle: 260°



	<b>ACT-FLL-049</b>	E27	7	6.000	100-240	560	260°			>30.000	60	115	340 x 140 x 130	<b>10</b>
	<b>ACT-FLL-050</b>	E27	7	3.000	100-240	560	260°			>30.000	60	115	340 x 140 x 130	<b>10</b>

Los pedidos de lámparas siempre deben respetar las unidades de embalaje reflejadas en esta página. Todas las bombillas son de 1ª marca  
Light bulbs POs shall always be placed according to the packaging units reflected in the present page. All light bulbs are first quality.  
Les commandes d'ampoules doivent toujours respecter les unités d'emballage figurant sur cette page. Toutes les ampoules sont de grande marque  
Bei Bestellungen von Leuchtmitteln bitte die auf dieser Seite angegebenen Verpackungseinheiten beachten. Alle Leuchtmittel sind von namhaften Fabrikanten.  
Gli ordini relativi alle lampadine devono tenere in conto le unità di imballaggio evidenziate in questa pagina. Tutte le lampadine sono di marca.  
Os pedidos de lâmpadas devem respeitar sempre as unidades de embalagem refletidas nesta página. Todas as lâmpadas são de 1ª marca.  
При составлении заказа необходимо учитывать количество единиц в упаковке, обозначенных на данной странице. Все лампы от лучших производителей.  
Zamówienia na źródła światła powinny być przygotowywane zgodnie z pakowaniem pokazanym na tej stronie. Wszystkie źródła światła są najwyższej jakości.

1-El uso de lámparas de mala calidad, afecta directamente a la vida útil de la reactancia.  
2-En los casos de reactancias de uso independiente utilizadas en downlights, es importante no cubrir el equipo con mantas térmicas utilizadas habitualmente para aislar los techos.  
3-Después de un corte en el suministro eléctrico, es importante desconectar la luminaria de manera que cuando se reanude el suministro ésta se encuentre desconectada.  
4-Importante tener la precaución de no combinar en una misma instalación equipos magnéticos y equipos electrónicos, ya que éste puede ser motivo de reducción de horas de vida de una reactancia electrónica.

1-Using bad quality lamps will directly affect the life span of the ballast  
2-When talking about ballasts for individual use commonly used in downlights, it's necessary to clarify that the gear cannot be covered with thermic blankets normally used to isolate ceilings.  
3-After a power failure, it is important to unplug the light fitting, and it should be kept so when the power supply is renewed.  
4-It is important to pay attention not to combine magnetic and electronic ballasts on the same installation, as this would reduce the life of the electronic ballasts.

1-L'utilisation d'ampoules de mauvaise qualité affecte directement la durée de vie utile du ballast.  
2-Dans le cas des ballasts à utiliser indépendamment dans les downlights, il est important de ne pas couvrir ces dispositifs à l'aide des couvertures thermiques qui servent habituellement à isoler le plafond.  
3-Après une coupure d'alimentation électrique, il importe de débrancher le luminaire de sorte que ce dernier se trouve éteint au rétablissement du courant.  
4-Il convient de veiller à ne pas combiner dans une même installation des dispositifs magnétiques et des dispositifs électroniques, car cela peut réduire la durée de vie d'un ballast électronique.

1-Die Verwendung von Lampen geringer Qualität kann die Lebensdauer der elektronischen Vorschaltgeräte direkt beeinträchtigen.  
2-Für einen einwandfreien Betrieb der unabhängigen elektronischen Vorschaltgeräte für die Downlights die Geräte nicht mit zur Dachisolierung verwendeten Dämmplatten abdecken.  
3-Wenn es zu einem Stromausfall kommt, die Lampe ausschalten bzw. vom Stromanschluss trennen, damit sie bei Rückkehr der Stromversorgung abgeschaltet ist.  
4-Es muss besonders darauf geachtet werden, in einer Anlage keine magnetischen und elektronischen Geräte zu kombinieren, da dies die Lebensdauer der elektronischen Vorschaltgeräte direkt beeinträchtigen kann.

1-L'utilizzo di lampade di cattiva qualità ha conseguenze negative sulla vita utile della reattanza.  
2-Nei casi di reattanze di uso indipendente utilizzate nei downlight, è importante non coprire il dispositivo con coperte termiche normalmente utilizzate per isolare i soffitti.  
3-Dopo un black-out, scollegare la lampada in modo che quando la corrente viene riallacciata la lampada sia scollegata.  
4-È importante fare attenzione a non combinare dispositivi magnetici ed elettronici nella stessa installazione, poiché ciò può comportare una riduzione delle ore di vita di una reattanza elettronica.

1-A utilização de lâmpadas de fraca qualidade afeta diretamente o tempo de vida útil da reatância.  
2-Nos casos de reatâncias de uso independente utilizadas em focos, é importante não cobrir o equipamento com mantas térmicas utilizadas normalmente para isolar os tetos.  
3-Na sequência de um corte de energia elétrica, é importante desligar a luminária para que, aquando do restabelecimento, esta esteja desligada.  
4-É importante ter o cuidado de não combinar numa única instalação equipamentos magnéticos e equipamentos eletrônicos, na medida em que esta situação pode causar a redução de horas de vida de uma reatância eletrônica.

1-Использование ламп ненадлежащего качества сокращает сроки эксплуатации ПРУ.  
2-Для встраиваемых потолочных светильников в случае, если оборудование не встроено, запрещается его изолирование теплозащитными материалами, используемыми для изоляции потолка.  
3-При отключении электроэнергии необходимо выключить светильник так, чтобы при возобновлении тока, светильник находился в отключенном состоянии.  
4-Избегать одновременного подключения в одну сеть магнитного и электронного оборудования, поскольку это может привести к сокращению срока службы электронной ПРУ.

1-Używanie słabej jakości źródeł światła wpłynie negatywnie na żywotność układu zapłonowego.  
2-Układy zapłonowe używane indywidualnie w lampach typu downlight nie mogą być przykrywane izolacją cieplną używaną do ocieplania sufitów.  
3-Po zaniku prądu oprawy należy odłączyć od źródła prądu do momentu powrotu zasilania w sieci.  
4-Ważnym jest, aby nie łączyć magnetycznych i elektronicznych układów zapłonowych.

REF.	COLLECTION	PAG.
00-2403	LEDAGIO	59
00-0001	CIRC	35
00-0002	CIRC	35
00-0003	NET	23
00-0049	SKY	56
00-0052	SKY	56
00-0053	RINGOFIRE	17
00-0054	RINGOFIRE	17
00-0056	TANDEM	21
00-0087	TWINS	48
00-0221	ADAGIO	62
00-0338	LINEAR	69
00-0489	LEDAGIO	59
00-0504	LEDAGIO	59
00-0641	CIRC	35
00-0642	CIRC	35
00-0643	NET	23
00-0678	TANDEM	21
00-0778	TANDEM	21
00-0779	NET	24
00-0826	NET	24
00-2392	SKY	56
00-2397	SLIMM	71
00-2407	LEILA	77
00-2673	TEMPO	66
00-2725	SHI	51
00-2726	UMBRELLA	32
00-2727	UMBRELLA	32
00-2801	SILUET	52
00-2804	TROPPO	65
00-2872	CLEAR	26
00-4348	BALLOONS	39
00-4391	BLOMMA	43
00-4409	EMY	46
00-4413	IRIS	45
00-4416	TULIP	37
00-4424	LEDAGIO	59
00-4425	LEDAGIO	59
00-4601	SPIN	74
00-4604	SPIN	74
00-4605	SPIN	74
00-4607	SPIN	74
00-4608	SPIN	74
00-4613	SPIN	74
00-4615	SPIN	74
00-4616	SPIN	74
00-4617	SPIN	74
00-4618	SPIN	74
05-0047	LOV	98
05-0221	ADAGIO	139
05-0265	MIRROR	123
05-0266	MIRROR	123
05-0325	DUNA	130

REF.	COLLECTION	PAG.
05-0380	SUITE	107
05-0381	SUITE	109
05-0382	SUITE	109
05-0567	LEVEL	138
05-0570	FLAT	121
05-0571	FLAT	121
05-0644	LOV	98
05-0647	LOV	98
05-0658	LOV	101
05-0677	LOV	101
05-1817	RIZZ	84
05-1818	RIZZ	84
05-1819	RIZZ	84
05-1822	RIZZ	84
05-1940	HALL	116
05-1941	HALL	114
05-2271	HOTELS	112
05-2273	HOTELS	112
05-2366	FLAT	121
05-2367	FLAT	121
05-2397	SLIMM	129
05-2572	BOOMERANG	132
05-2573	BOOMERANG	132
05-2574	CIAO	133
05-2708	OPEN	104
05-2870	TRAC	136
05-4356	SKATA	126
05-4394	BEND	94
05-4395	BEND	94
05-4409	EMY	118
05-4415	SUPPLE	103
05-4716	LEDBOX	89
05-4717	LEDBOX	91
05-4718	LINE	97
05-4719	LINE	97
05-4720	LOV	98
10-0055	SWAY	151
10-0080	OFFICE	157
10-0378	SUITE	159
10-0381	SUITE	160
10-1824	MEDUSA	145
10-2056	BONNE NUIT	165
10-2708	OPEN	155
10-2709	OPEN	155
10-4391	BLOMMA	147
10-4409	EMY	162
10-4413	IRIS	149
10-4415	SUPPLE	152
15-0003	NET	184
15-0008	HAT	218
15-0056	TANDEM	175
15-0079	QUATTRO	201
15-0157	SKA	209

REF.	COLLECTION	PAG.
15-0158	SKA	209
15-0221	ADAGIO	197
15-0222	MINI	223
15-0223	MINI	222
15-0256	MINI	223
15-0590	SQUARE	204
15-0591	SQUARE	204
15-0592	SQUARE	204
15-0635	QUATTRO	201
15-0638	QUATTRO	201
15-0778	TANDEM	175
15-0835	NET	184
15-1815	GLOBAL	183
15-1816	GLOBAL	183
15-1950	SIX	170
15-1956	SIX	170
15-1959	SIX	170
15-2138	MOON	189
15-2385	BASIC	206
15-2386	BASIC	206
15-2391	BASIC	206
15-2410	ACE	178
15-2411	ACE	181
15-2412	ACE	178
15-2575	SKA	209
15-2779	ONA	199
15-2780	ONA	199
15-2781	ONA	199
15-2782	ESCHER	194
15-2804	TROPPO	193
15-2806	OCHO	211
15-2807	OCHO	211
15-2870	TRAC	186
15-4314	SLIGHT	203
15-4316	SLIGHT	203
15-4318	SLIGHT	203
15-4332	NEMO	221
15-4407	PETRA	216
15-4408	PETRA	216
15-4601	SPIN	214
15-4604	SPIN	214
15-4605	SPIN	214
15-4607	SPIN	214
15-4608	SPIN	214
15-4613	SPIN	214
15-4615	SPIN	214
15-4616	SPIN	214
15-4617	SPIN	214
15-4618	SPIN	214
15-4716	LEDBOX	225
20-0313	ADAGIO	63
20-0326	DUNA	68
20-0536	ADAGIO	63

REF.	COLLECTION	PAG.
20-2407	LEILA	79
25-0057	HOOP	242
25-0058	HOOP BALLOONS	239
25-0221	ADAGIO	269
25-0378	SUITE	259
25-0381	SUITE	258
25-1823	MEDUSA	231
25-1824	MEDUSA	231
25-1837	BOSQUET	235
25-2384	TOTEM	271
25-2407	LEILA	256
25-2580	ARC	267
25-2708	OPEN	260
25-2803	EVERYDAY OUTDOOR	246
25-4391	BLOMMA	249
25-4409	EMY	255
25-4413	IRIS	251
25-4415	SUPPLE	263
25-4423	KUBIK	264
71-0053	RINGOFIRE	17
71-1759	MEDUSA	231
71-2232	TRACK CONECTOR	26, 37, 48
71-2241	REMOTE CONTROL	23, 24, 35, 184
IBIS C/17	IBIS	190
IBIS C/27	IBIS	190
IBIS C/37	IBIS	190
IBIS C/47	IBIS	190
PAN 178	DRESS UP	111
PAN 186	DRESS UP	111
PAN 187	DRESS UP	111
PAN 188	DRESS UP	111
PAN-157	DRESS UP	111
PAN-158	DRESS UP	111
PAN-161	DRESS UP	111
PAN-162	DRESS UP	111
PAN-175	DRESS UP	111
PAN-176	DRESS UP	111
PAN-177	DRESS UP	111
PAN-179	DRESS UP	111
PAN-180	DRESS UP	111
PAN-194	DRESS UP	111



## Información general / General information / Information générale / Allgemeine informationen / Informazione generale / Informação geral / Общая информация / Ogólna informacja

• Las descripciones y medidas de los aparatos del presente catálogo son orientativas, pudiendo por tanto ser modificadas, a fin de mejorar las características técnicas o de diseño. • La empresa se reserva el derecho de anular o modificar cualquier modelo sin previo aviso. • Todos los modelos presentados cumplen las normas exigidas por la C.E. para aparatos de iluminación de uso doméstico y sus características vienen determinadas por las clases I y II. • Los acabados y las especificaciones técnicas corresponden a los productos que se suministran en Europa, pudiendo éstos variar en otros mercados. • Para una buena conservación de las lámparas, no usar bombillas de potencia superior a las recomendadas y limpiar simplemente con un paño seco. No usar limpia metales, ya que dañan los barnices protectores que garantizan la duración del acabado.

• The descriptions and dimensions of the items in this catalogue are indicative and may be modified for the purpose of technical or design improvements. • We reserve the right to cancel or change all models without prior notice • All items meet the E.C. Class I and Class II safety regulations for home lighting appliances. • The finishes and technical specifications listed here are for the European market and may vary elsewhere. • Do not use stronger bulbs than recommended, and always clean lamps with a soft dry cloth alone since metal polish will damage the protective finish.

• Les descriptions et mesures des appareils de ce catalogue sont données à titre d'orientation, pouvant être modifiées dans le but d'améliorer les caractéristiques techniques ou de design. • L'usine se réserve le droit d'annuler ou modifier l'un ou l'autre de ses modèles sans avis préalable. • Tous les modèles présentés sont conformes aux normes exigées par la C.E. pour les appareils d'éclairage domestique et leur caractéristiques sont déterminées par la classe I et II. • Les finitions et spécifications techniques correspondent à la demande du marché européen. Elles peuvent être modifiées pour d'autres pays. • Ne pas utiliser d'ampoules d'une puissance supérieure à celle recommandée. Pour un bon entretien, utiliser simplement un chiffon sec. N'utilisez aucun produit pour métaux, ils abîment le vernis protecteur.

• Die Beschreibung und Maße der in diesem Katalog aufgeführten Modelle dienen der Orientierung und können zur Verbesserung der technischen Eigenschaften oder des Designs geändert werden. • Der Hersteller behält sich das Recht vor, Modelle zu ändern oder aus dem Programm zu nehmen. • Die gezeigten Modelle erfüllen alle die innerhalb der EU geforderten Normen und Richtlinien für Leuchten für allgemeine Beleuchtungszwecke der Schutzklassen I und II. • Die Ausführungen und technischen Daten gelten für den europäischen Markt und können in anderen Ländern abweichen. • Für eine gute Erhaltung der Leuchten ist der Betrieb mit Lampen höherer Leistung als empfohlen zu vermeiden. Zur Reinigung benutzen Sie einfach ein trockenes Tuch, da Metallputzmittel die Schutzlackierung angreifen.

• Le descrizioni e le dimensioni degli articoli del presente catalogo vengono fornite a mero titolo orientativo e possono pertanto essere modificate al fine di migliorarne le caratteristiche tecniche o di design. • La Casa si riserva il diritto di cessare la produzione o di modificare qualsiasi modello senza preavviso. • Tutti i modelli presentati sono conformi alle normative C.E. per gli articoli da illuminazione per uso domestico di classe I e II. • Le rifiniture e le specifiche tecniche corrispondono ai prodotti venduti in Europa; tali dati possono pertanto variare su altri mercati. • Per una buona conservazione delle lampade, non utilizzare lampadine di potenza superiore a quella consigliata e pulirle semplicemente con un panno asciutto. Non utilizzare prodotti per la pulizia del metallo che potrebbero rovinare le vernici di protezione che garantiscono la vita della rifinitura.

• As descrições e medidas dos modelos do presente catálogo são orientativas podendo, portanto, ser modificadas com o fim de melhorar as características técnicas ou de desenho. • Medidas em cm. • L.E.D.S reserva-se o direito de anular ou modificar qualquer modelo sem aviso prévio. • Todos os modelos apresentados cumprem as normas CE para aparelhos de iluminação de uso doméstico e as suas características de protecção estão definidas pelas Classes I ou II. • Para uma boa conservação dos aparelhos, nunca usar lâmpadas de potência superior à recomendada nem usar produtos para limpeza de metais porque podem danificar os vernizes de protecção que garantem a duração do acabamento. Para limpeza usar apenas um pano seco. • Recomenda-se não molhar as luminárias com água de rega que contenha um elevado grau de sais ou ácidos. • As potências indicadas para as lâmpadas PL electrónicas correspondem às marcas Osram, Philips ou GE indistintamente, excepto se se especifica alguma marca em concreto.

• Описания и размеры, фигурирующие в этом каталоге, являются приблизительными, поэтому они могут изменяться в случае улучшения технических характеристик или дизайна изделий. • Фирма-изготовитель оставляет за собой право на снятие с производства или модификацию любой модели без предупреждения • Все представленные модели отвечают нормам ЕС для домашних осветительных приборов, их характеристики соответствуют классам I и II • Типы отделки и технические характеристики соответствуют продукции, поставляемой в Европу; на иных рынках данные показатели могут меняться. • Для обеспечения максимального срока службы светильников, не рекомендуется использовать лампы, мощность которых, превышает рекомендованную. Для гигиенической обработки светильника используйте сухую тряпку. Не используйте средства для чистки металлов, так как они могут повредить лак, покрывающий и защищающий внешнюю сторону светильника

• Opisy i wymiary urządzeń z niniejszego katalogu są orientacyjne, mogą zatem ulec zmianie w celu ulepszenia właściwości technicznych lub wzornictwa. • Firma zastrzega sobie prawo do wycofania lub zmodyfikowania jakiegokolwiek modelu bez wcześniejszego uprzedzenia. • Wszystkie przedstawione modele spełniają przepisy wymagane przez CE dla urządzeń oświetleniowych do użytku domowego, a ich cechy charakterystyczne są określone klasami I i II. • Wykończenia i specyfikacje techniczne odpowiadają produktom jakie są dostarczane w Europie, mogą one różnić się na innych rynkach. • Dla odpowiedniej konserwacji lamp nie stosować żarówek o mocy wyższej niż zalecana i czyścić suchą szmatką. Nie stosować środków do czyszczenia metali, gdyż uszkadzają one lakiery ochronne, które zapewniają trwałość wykończeń.

• Todos los derechos reservados. Ninguna parte de este libro puede ser reproducida en ningún formato de papel o electrónico, sin el consentimiento previo del editor o de los propietarios de los derechos.

• All rights reserved. No part of this publication may be reproduced or transmitted in any form or by any means, electronic storage and retrieval system, without permission in writing from the copyright owner (s).

• Tous droits réservés. Aucune partie de ce livre ne pourra être reproduite en format papier ou électronique sans l'autorisation préalable de l'éditeur ou du propriétaire des droits.

• Sämtliche Rechte vorbehalten. Kein Teil dieses Buches darf in keinem Papier-oder elektronischem Format ohne ausdrückliche Zustimmung des Herausgebers oder der Inhaber der Urheberrechte wiedergegeben oder vervielfältigt werden.

• Tutti i diritti riservati. Nessuna parte di questo libro può essere riprodotta in nessun formato cartaceo o elettronico, senza la previa autorizzazione dell' editore o dei proprietari dei diritti.

• Todos os direitos reservados. Nenhuma parte deste livro pode ser reproduzida em nenhum formato de papel ou electrónico, sem o consentimento prévio do editor ou dos proprietários dos direitos.

• Все права защищены. Запрещено использование любого материала из данного каталога без разрешения носителя прав собственности.

• Wszystkie prawa zastrzeżone. Żadna część niniejszej publikacji nie może być powielana w żadnym formacie papierowym ani elektronicznym bez wcześniejszej zgody wydawcy lub właścicieli tych praw.



## OUTDOOR

Luminarias diseñadas para la máxima resistencia a las condiciones ambientales, con una amplia oferta que incluye desde el estilo contemporáneo y moderno hasta diseños más clásicos.

Luminaires specially designed for the maximum resistance to environmental conditions with a wide range including both contemporary and classical models.



## ARCHITECTURAL

Soluciones lumínicas de altas prestaciones para espacios comerciales, oficinas u obras contract.

Producto singular por su calidad, funcionalidad y facilidad de instalación y mantenimiento.

High-performance light solutions for commercial spaces, offices or contract works.

Product which is unique due to its quality, functionality and ease of installation and maintenance.



## LA CREU

Luminarias decorativas con una excelente relación calidad-precio, de todos los estilos: moderno, clásico, tradicional y rústico .. y aptas para distintas aplicaciones: dormitorios, salones, baños, zonas públicas.

Decorative luminaires with an excellent price-quality ratio in all styles: modern, classical, traditional and rustic and suitable for different applications: bedrooms, living rooms, bathrooms and public areas.



## URBAN

Luminarias para alumbrado urbano, tanto de zonas residenciales como de alumbrado vial, con distintas soluciones pensadas para favorecer el ahorro energético y la anticontaminación lumínica.

Luminaires for urban lighting both in residential areas as well as road lighting, with specific solutions designed to promote energy saving and anti-light pollution.



## ALABASTER

Luminarias en alabastro tanto de estilo barroco como de estilo contemporáneo. Y aplicaciones lumínico-arquitectónicas (paneles, cornisas y espejos) en alabastro para los ambientes más sofisticados.

Alabaster luminaires both in baroque and contemporary style. And light-architectonic applications (panels, cornices and mirrors) made of alabaster for more sophisticated environments.



## VENTILACIÓN CEILING FANS

Cuidada selección de ventiladores con opciones para todos los estilos decorativos. Modelos silenciosos y con las más altas prestaciones, que favorecen el ahorro energético.

Careful selection of fans with options for all decorative styles. Silent models with the highest performance, which promote energy saving.



**LEDS-C4, S.A.**

Afuera s/n  
25750 Torà (Lleida)  
SPAIN  
[www.leds-c4.com](http://www.leds-c4.com)



**España**

Tel.: 973 468 101  
Fax.: 973 468 129  
e-mail: [info@leds-c4.com](mailto:info@leds-c4.com)

**France**

Tel.: + 34 973 468 130  
Fax.: + 34 973 468 129  
e-mail: [france@leds-c4.com](mailto:france@leds-c4.com)

**Portugal**

Tel.: + 34 973 468 130  
Fax.: + 34 973 468 129  
e-mail: [portugal@leds-c4.com](mailto:portugal@leds-c4.com)

**Europe**

Tel.: + 34 973 468 102  
Fax.: + 34 973 468 106  
e-mail: [europe@leds-c4.com](mailto:europe@leds-c4.com)

**América Latina**

Tel.: + 34 973 468 115  
Fax.: + 34 973 468 106  
e-mail: [sudamerica@leds-c4.com](mailto:sudamerica@leds-c4.com)

**USA - Canada**

Tel.: +34 973 468 109  
Fax: +34 973 468 106  
e-mail: [lighting@leds-c4.com](mailto:lighting@leds-c4.com)

**Asia - Pacific & Africa**

Tel.: + 34 973 468 116  
Fax.: + 34 973 468 106  
e-mail: [export@leds-c4.com](mailto:export@leds-c4.com)

**Middle East Countries**

Tel.: + 34 973 468 108  
Fax.: + 34 973 468 106  
e-mail: [dep-export@leds-c4.com](mailto:dep-export@leds-c4.com)



 Class I • Class I • Classe I • Classe I • Classe I • Classe I • Klasse I • Klasse I • Klasse I • Klasse I • Klasse I • Klasse I

 Clase II • Class II • Classe II • Classe II • Classe II • Classe II • Klasse II • Klasse II • Klasse II • Klasse II • Klasse II • Klasse II

 Clase III • Class III • Classe III • Classe III • Classe III • Classe III • Klasse III • Klasse III • Klasse III • Klasse III • Klasse III • Klasse III

 Luminarias no adecuadas para cubrirse con material aislante térmico • Luminaires should never be covered with any heat insulating material • Les luminaires ne devraient pas être couverts par du matériel isolé thermique • Nicht geeignet für eine Installation in einer isolierten Decke • Apparecchi inappropriati per essere coperti con materiale isolante termico • Estas luminárias não podem ser cobertas com material isolante térmico • Не допускается теплоизоляция данных светильников • Органу nigdy nie powinny być przykrywane materiałem izolującym ciepło.

 Luminarias no adecuadas para el montaje directo en superficies normalmente inflamables • Non suitable for direct installation on normally inflammable surfaces • Luminaires inadéquates pour le montage direct sur des surfaces qui sont normalement inflammables • Montage auf normal entflammbaren Oberflächen nicht zulässig • Apparecchi inappropriati per montaggio su superfici infiammabili • Estas luminárias não podem ser montadas diretamente sobre superficies normalmente inflamáveis • Не допускается установка данных светильников на легковоспламеняющихся поверхностях • Nie instalować bezpośrednio na powierzchniach łatwopalnych.

 Fabricado según normas de seguridad y electromagnetismo de Europa • Manufactured according to the set safety and electromagnetism standards of Europe • Fabriqués en conformité avec les normes de sécurité et d'électromagnétique de l'Europe • Hergestellt nach den in Europa geltenden Sicherheits- und elektromagnetischen Bestimmungen • Tutti i prodotti fabbricati rispettano le norme di sicurezza e di elettromagnetismo europeo • Fabricado de acordo com as normas de segurança e electromagnetismo da Europa • Изготовлено в соответствии с европейскими стандартами для электронного и электромагнитного оборудования. • Wyprodukowane zgodnie z zasadami europejskich standardów bezpieczeństwa i elektromagnetyki.

 Resistente al hilo incandescente a 850°C • Resistance to incandescent wire at 850°C • Tenue au feu 850°C • Glühdrahtbeständig auf 850°C • Resistente a filo incandescente 850°C • Resistente ao fio incandescente a 850°C • Прошло испытание спиралью накаливания 850°C • Odporność na drut żarowy o temperaturze 850°C

 Equipo no incluido • Gear not included • Équipement non compris • Gerät nicht mitgeliefert • Trasformatore non incluso • Equipamento nao incluido • Оборудование не включено • Zasilacz nie dotaczony

 Equipo electrónico • Electronic gear • Équipement électronique • Elektronische Vorschaltgerät • Dispositivo electrónico • Aparelho electrónico • Электронный балласт • Osprzet elektroniczny

 Equipo magnético • Magnetic gear • Equipement magnétique • Magnetische Vorschaltgerät • Dispositivo magnetico • Equipamento magnético • Магнитный балласт • Osprzet magnetyczny

 Sistema de codificación para indicar el grado de protección proporcionado por una envolvente contra la entrada de elementos sólidos y líquidos • A coding system that shows the degree of protection that a casing provides against the penetration of solid objects or dust and liquids • Système de codification permettant d'indiquer le degré de protection procuré par une enveloppe contre la pénétration de corps solides, poussières et liquides • Dieses Codierungssystem dient zur Angabe des Schutzgrades, der mit einer besonderen Verkleidung zum Schutz gegen das Eindringen fester Gegenstände, Staub oder Flüssigkeiten erreicht wird • Sistema di codifica per indicare il grado di protezione offerto da un involucro contro la penetrazione di oggetti solidi, di polvere, o di liquidi • Sistema de codificação para a indicação do grau de protecção proporcionado por um invólucro contra a penetração de objectos sólidos ou pó e líquidos • Система кодирования для обозначения степени защиты корпуса против попадания твердых и жидких элементов • System kodowania wskazujący na stopień ochrony przed wnikaniem ciał obcych, kurzu i wody.

 Instalación en el techo • Ceiling installation • Installation au plafond • Deckenmontage • Installazione a soffitto • Instalação no tecto • Установка под потолком • Instalacja sufitowa

 Distancia mínima entre el foco de la luminaria y el objeto iluminado • Minimum distance to be left between the focus of the lighting fixture and the lighted object • La distance minimum pour être gauche entre le foyer de l'accessoire d'éclairage et l'objet allumé • Mindestabstand zwischen dem Scheinwerfer der Leuchte und dem beleuchteten Gegenstand • Distanza minima tra la lampada e l'oggetto illuminato • Distância mínima entre o foco da luminaria e o objeto iluminado • Минимальное расстояние между световым фокусом и освещаемым объектом. • Minimalna odległość do zachowania pomiędzy czołem lampy a oświetlanym obiektem.

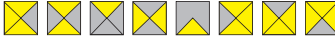
 Dirección del halo de luz • Halo light direction • Direction du faisceau lumineux • Halo Lichtrichtung • Direzione del Fascio di luce • Direcção do feixe de luz • Направление света. • Kierunek łuny światła

 Uds. de embalaje • Items per box • Unité d'emballage • Verpackungseinheiten • Unità d'imballaggio • Uds. de embalagem • Количество единиц в коробке • Sztuk w pudełku

 Modelos registrados • Registered models • Modèles enregistrés • Eingetragene Modelle • Modelli registrati • Modelos registados • Зарегистрированные модели • modele zastrzeżone

 Bajo consumo • Energy saving • Économie d'énergie • Energiesparlampe • Risparmio energetico • Baixo consumo • Энергосберегающий • Energooszczędny

 Luz cálida • Warm light • Lumière chaude • Warmweißes Licht • Luce calda • Luz quente • Теплый свет • Ciepłe światło

 Lumens/watios • Lumens/Watts • Lumens/watt • Lumen/Watt • Lumen/Watt • Lumens/watts • Lumenów/watów • Люмены/ватты

 Material difusor • Diffuser material • Material diffusant • Difuseur Material • Materiale diffusore • Material difusor • Материал диффузора • Material rozpraszający

 Material pantalla • Shade material • Matériels Abat-jour • Material des Schirmes • Materiale del paralume • Material Abajur • Материал абажура • Material abazuru

 Regulador de intensidad • Dimmer • Régulateur d'intensité • Mit dimmer • Con regolatore d'intensità • Com regulador de intensidade • Переключатель яркости • Sciemiencz

 Interruptor de encendido • On/off switch • Interrupteur simple allumage • Schalter • Interruttore di accensione • Interruptor on/off • Клавишный выключатель • Włącznik

 Doble interruptor de encendido • Double on/off switch • Interrupteur double allumage • Doppel Schalter • Doppio interruttore di accensione • Duplo interruptor on/off • Два клавишных выключателя • Włącznik podwójny

 Interruptor de encendido en el cable • Cable on/off switch • Interrupteur d'allumage sur le câble • Schalter am Kabel • Interruttore d'accensione nel cavo • Cabo com interruptor on-off • Выключатель на проводе • Wyłącznik w przewodzie

 Interruptor de cuerda • Pull cord switch • Interrupteur a ficelle • Strickschalter • Interruptor de cordão • Interruttore a corda • Выверочный выключатель • Włącznik sznurowy

 Orientable • Adjustable • Orientable • Verstellbar • Orientabile • Ajustável • Регулируемый • Regulowane

 Apto para posición vertical y horizontal • Suitable for vertical and horizontal mounting • Installation en position verticale et horizontale • Schenkrecht und waagrecht geeignet • Adatto in verticale ed in orizzontale • Apto para posição vertical e horizontal • Вертикально-горизонтальное расположение • Montaż poziomy i pionowy

 Sistema de apertura abatible • Collapsible opening system • Système d'ouverture rabattable • Kippbares Öffnungssystem • Sistema di apertura ribaltabile • Sistema de abertura reciclável • Открывается в двух направлениях • Składany system otwierania

 Consultar disponibilidad • Check availability • Vérifiez la disponibilité • Bitte nach Verfügbarkeit fragen • Verificare la disponibilità • Consultar disponibilidade • Проверить наличие • Spytaj o możliwość

 Consulte con equipo comercial • Please contact our sales team • Consultez l'équipe commerciale • Bitte wenden Sie sich an unsere Vertriebsmitarbeiter • Consultare il team di vendita • Consulte a n/ Equipa Comercial • Проконсультируйтесь у наших менеджеров по продажам • Proszę skonsultować się z działem handlowym

 Mando a distancia • Remote control • Télécommande • Fernbedienung • Telecomando • Comando à distância • Пульт управления • Pilot zdalnego sterowania

 Controlador con mando a distancia • Controller with remote control • Contrôleur avec télécommande • Controller mit Fernbedienung • Regolatore con telecomando • Controlador com comando à distância • Контроллер с дистанционным управлением • Nastawnik z pilotem zdalnego sterowania

 Pilas incluidas • Batteries included • Piles fournies • Batterien inklusive • Pile incluse • Pilhas incluidas • Батарейки в комплекте • Łącznie z bateriami



Grok

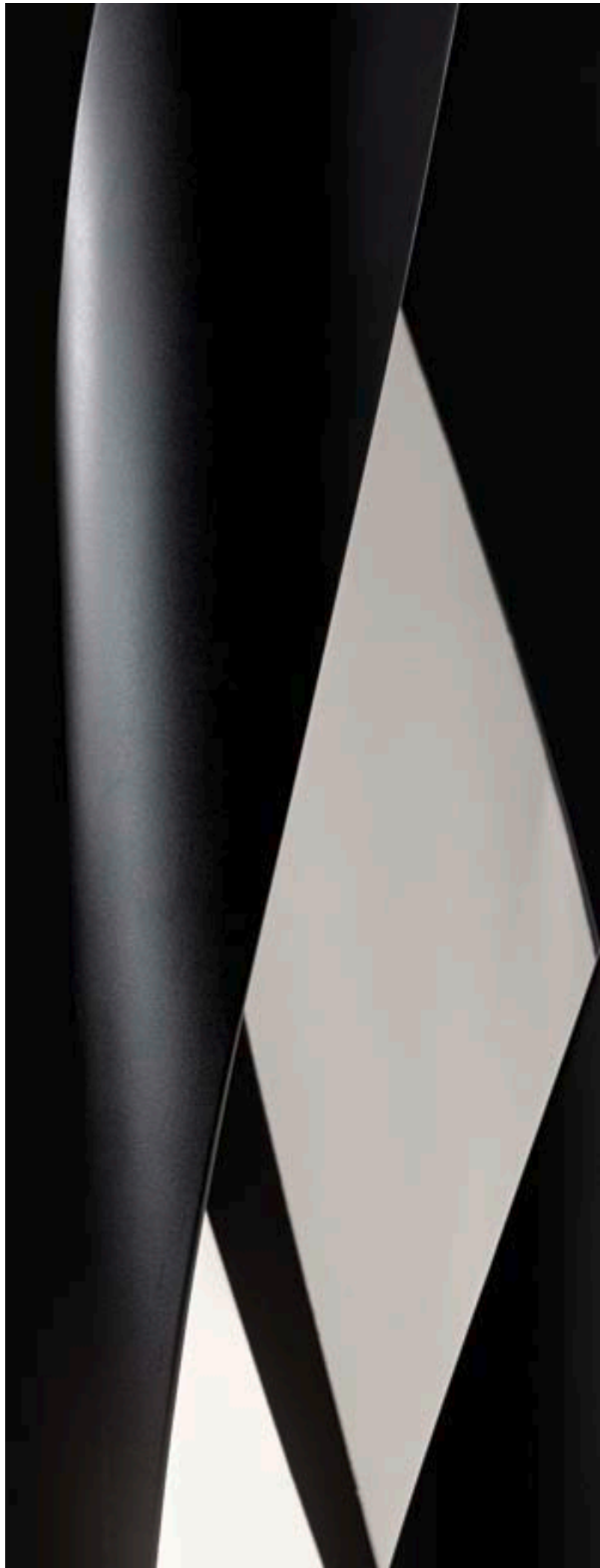

Afueras s/n  
25750 Torà (Lleida)  
SPAIN

[www.leds-c4.com](http://www.leds-c4.com)